



The Nation's Favourite

GO WITH
THE NATION'S
FAVOURITE

Caravans 2024





WHERE NEXT?



Welcome to Bailey, The Nation's Favourite.

We've been proudly hitting the road for over 75 years. Along the way, we've built hundreds of thousands of Bailey caravans and motorhomes, each of them made with one thing in mind: creating the perfect holiday.

So, no matter which of our models you choose for your home away from home; comfort, convenience and adventure are built into every one.

GO BAILEY! We can't wait to see you out there.

Contents

Bailey heritage	02	Alicanto Grande	10
Sustainability	03	Pegasus Grande GT75	16
Made in Bristol	04	Unicorn	24
Tested to the limit	06	Phoenix GT75	32
Choose your Bailey	08	Discovery	40
		Where to buy	46
		Bailey Owners Club	47
		PRIMA accessories	48

Bailey by name...

The Bailey story started back in 1947, when Martin Bailey designed and built the very first Bailey caravan in South Bristol. A year later in 1948, F G Bailey Ltd was formed and their caravans captured the nation's growing quest for adventure. Bailey quickly grew into the thriving, family-run business it still is today.

We've come a long way since those early days, but even with 75 years of experience now behind us, we have never stopped considering how we can push the boundaries and make our business better. And, like you, we continue to look towards to our next adventure...

To learn more about our history and heritage, visit our '75 Years and Counting' page on the Bailey website or scan the QR below.



Our road to sustainability

Caravans and motorhomes have long provided environmentally friendly holidays for people who have an appreciation for the great outdoors and who want to see it remain protected.

At Bailey, we remain committed to playing our part in this process by reducing the environmental footprint of our operations and striving to make our leisure vehicle products as sustainable as possible. Over recent years we have undertaken a range of initiatives designed to reduce our impact on the environment, covering our products, our sites and our culture.

In 2022 we signed up to the Woodland Trust Woodland Carbon Scheme to help reduce the environmental impact of our operations and at the same time boost biodiversity through the planting of trees. Consequently, when customers now purchase new Bailey caravans or motorhomes, we are planting trees to help offset the carbon emissions generated when we manufacture them.

To learn more about this and the other changes we are making to become a greener business visit the Sustainable Manufacturing page on our website or scan the QR code below.



Made in Bristol

We've been proud to call South Bristol home since 1948. Martin Bailey designed and built the first Bailey caravan, just a stone's throw from the South Liberty Lane site that now houses our 14.5-acre production facility.

We think of ourselves as one big family. Most of us live nearby and have been part of Bailey for a long time (ten years is the average length of service).

From our joiners and electricians to our designers and fabricators, we have the skills, expertise and experience to build a complex range of caravans and motorhomes, all in the same plant – and all by hand.

For more information, head to our 'Manufacturing in Bristol' page on the Bailey site or scan the QR code below.



What goes into The Nation's Favourite?

It all started with a simple question: "Is there a better way?"

Leisure vehicle design and construction was stagnant for over 30 years, until we developed Alu-Tech and changed everything. Alu-Tech is a completely new approach to bodyshell construction. Using a unique interlocking aluminium framework to clamp the body panels together, Bailey created a shell that is more robust and durable than anything else on the market.

By significantly reducing the number of external joints and fixing points and using timber-free components in the upper bodyshell panels, we are able to provide greater protection against the elements. Thicker, better-insulated panels, cloaked in impact resistant GRP (Glass Reinforced Plastic), hugely improve the thermal performance of the bodyshell, for genuine four-season performance. All this with no increase in weight or cost. Turns out there really is a better way.



3 year transferable manufacturer's components warranty*
6 year transferable bodyshell integrity warranty*
Access to aftercare team

*Terms and conditions apply. Please visit baileyofofbristol.co.uk/warranties-servicing for more information.



Since Alu-Tech first hit the road ten years ago, we've built more than 75,000 leisure vehicles using Alu-Tech technology. To learn more about the unique features and benefits of Alu-Tech, head to the Bailey website.

- 1 Polystyrene core
- 2 Composite plastic extrusion
- 3 Alu-Tech rail
- 4 Structural fixing bracket
- 5 Alu-Tech rail insulation
- 6 GRP (Glass Reinforced Plastic) outer and inner skin

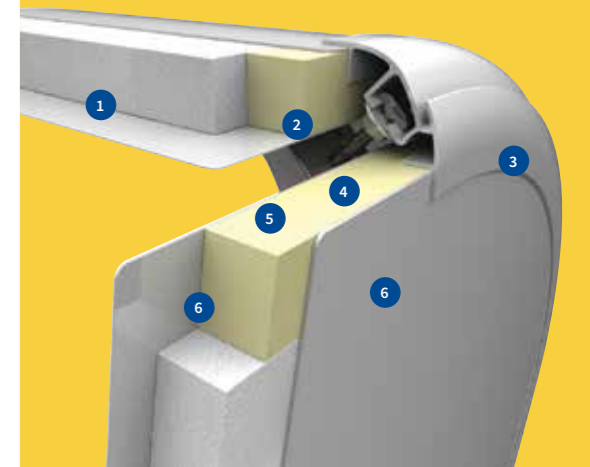

Tested to the limit

From desert dust to Arctic ice, we put our caravans through their paces, so they're at their best on the roads of Great Britain – and beyond.

Good enough simply isn't good enough. It's why we go to extreme lengths to make sure our caravans can perform, whatever's thrown their way. It's only through rigorous testing that we're satisfied our products are ready for the road. Every new range goes through test conditions that push the limits of what a caravan is likely to encounter in its lifetime.

Like our cold chamber testing, which goes down to -15°C to get the best possible results in thermal insulation with the help of our heating system partners.

If something's not up to the job, we go back to the drawing board until it is. That way, when our products hit the road, we know every single one is the best it can be. See how else we take our testing to the limit on our website and learn more about our Bailey Big Adventures by scanning the QR code.



Go anywhere, do everything

Cold chambers and test trucks are one thing, but few things beat getting out there properly.

In 2015, we took two caravans on a 3,500-mile journey through the Australian Outback. During the two-week trip, they stood up to everything the elements could throw at them, proving they could hold their own in even the toughest conditions.

In 2017, we embarked on another marathon endurance test; this time with two caravans and a motorhome, on a 5,000-mile trip to Northern Finland – and well inside the Arctic Circle. Conditions couldn't have been more different than the Red Centre of Australia, but once again the vehicles took everything in their stride.

The successes of these adventures really whet our appetite. So, we decided to embark on a third: 21 countries in 21 days, across two continents – without a rest. From Bristol to Istanbul, we're proud to say the vehicles were more than capable and eager for more – even if we were well in need of a break.

With our taste for adventure not quite satisfied, we hit the road hungry for more, and in 2023 completed our epic journey to the Sahara Desert. After our first attempt in 2020 was halted by the arrival of COVID-19, our successful journey to the Sahara and back proved the strength and endurance of Bailey vehicles once again.

Choose your Bailey

You'll find a quick summary of each of the five ranges on the following pages, then you can explore the features of each in much more detail. Scan the relevant QR code to see the full range on our website.



Touring caravan or an 8ft wide touring caravan?

Space comes as standard across all our ranges, but you can choose to go 8ft wide with the Alicanto Grande and Pegasus Grande GT75 ranges, for up to 25% more interior space.



ALICANTO GRANDE

p. 10

Luxurious & limitless

Generous in every direction, the 8ft wide Alicanto Grande is the last word in luxury. Choose from two fully specified layouts, where the only thing not included is the view.

There are three models to choose from in this range.

TWIN AXLE 2x models available with Twin Axle



PEGASUS GRANDE GT75

p. 16

Stylish & spacious

The 8ft wide Pegasus Grande GT75 has been designed to offer a unique range of generous layouts, perfect for relaxing or entertaining in style.

There are six models to choose from in this range.

TWIN AXLE 3x models available with Twin Axle



UNICORN

p. 24

Effortless & elegant

Effortless practicality meets simple elegance. Packed with features, the Unicorn range sets a new standard, so you can escape in both style and luxury.

There are seven models to choose from in this range.

TWIN AXLE 2x models available with Twin Axle



PHOENIX GT75

p. 32

Comfortable & capable

Strike the perfect balance between space, comfort and affordability, with the new Phoenix GT75 range. Are you ready for more?

There are six models to choose from in this range.

TWIN AXLE 1x model available with Twin Axle



DISCOVERY

p. 40

Compact & confident

Your passport to adventure has arrived. The updated contemporary styling and ingenious use of space make the Discovery your perfect partner to every escape. This value for money and lightweight range makes the great outdoors more accessible than ever before.

There are three models to choose from in this range.





FIVE-STAR ADVENTURE

Get to know Alicanto Grande

Packed to the rooflights with features, the Alicanto Grande is our flagship range, where comfort, style and practicality combine to take luxury to a whole new level.

You'll find smart use of space throughout, along with the latest appliances, technology and safety features – all in a package that's as comfortable touring as it is for seasonal use. Wherever you decide to take the Alicanto Grande, you'll turn heads.

3 Models

4 Berths

8ft

WIDE

Favourite facts

- Vertical infinity front window – with a 50% increase on window size
- Flush fit 'Piuma' side windows with integrated framed flyscreen and blinds
- AL-KO ATC trailer control system and stabiliser hitch
- Tracker Monitor system with integral intruder alarm, high security door lock and AL-KO wheel lock for extra security
- Truma 100 watt flexible solar panel for off-grid holidays
- External mains electrics and BBQ points
- Four season all weather sustainability with Alde radiator central heating system
- Tech ready with Avtec mobile WiFi and wireless charging pad
- Additional RGB colour change ambient lighting system
- 5ft wide king-size fixed island beds with superior pocket sprung 'Poise' mattress
- Rooflight mounted Omnivent extractor fan above kitchen

Key features

- 1 Vertical infinity front window and moulded surround with integral task lighting and speakers
- 2 Dual finish 'Satin Cashmere' British design overhead curved locker doors with 'Light Oak' contrasting stripe
- 3 Streamline front corner lockers
- 4 Optional 'Latimer' soft furnishings with practical Aquaclean fabric
- 5 Conventional cushion construction with fully sprung knee rolled base cushions, foam filled back rests and curved corner sections with removable head rests
- 6 L-shape kitchen design
- 7 'Hazelnut' deep pile loose fit drop in carpets



Scan to see
the full range



Model Lisbon



Model Lisbon

- 1 King-size fixed island bed with full width back lit soft touch fixed headboards
- 2 Bespoke caravan bedding sets to coordinate with caravan soft furnishings (cost option)
- 3 Superior pocket sprung 'Poise' fixed bed mattress
- 4 RGB colour change ambient lighting system

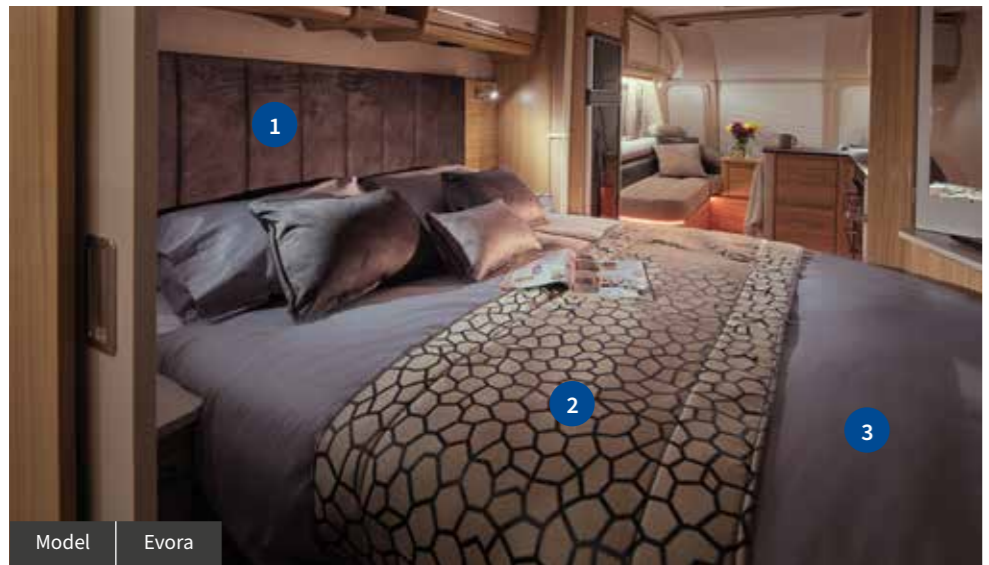
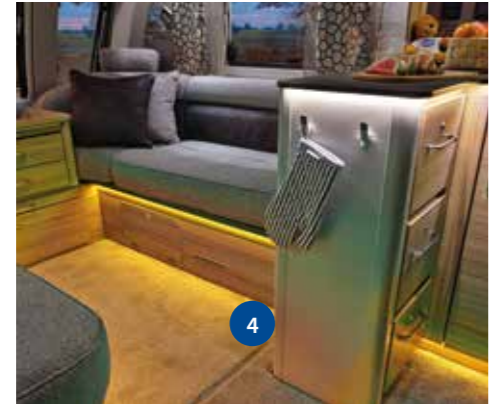

Model Evora



Scan to find your nearest retailer

- 5 Branded 700 watt integrated microwave oven with non-moving ceramic hot plate
- 6 Thetford dual fuel hob with electric hotplate and three gas burners
- 7 Washroom heated towel rail (model specific)
- 8 Standard 'Portobello' soft furnishings



Model Lisbon



Model Porto



Model Porto



Lisbon 4 ↑

Internal Length	6.112m/20'1"
Shipping Length	7.381m/24'3"
Overall Width	2.450m/8'0"
Overall Height	2.605m/8'7"
Internal Headroom	1.960m/6'5"
Awning Size	1031cm
Tyre Sizes	195/70 R15
MTPLM	1700kg
MRO	1546kg
Total User Payload	154kg

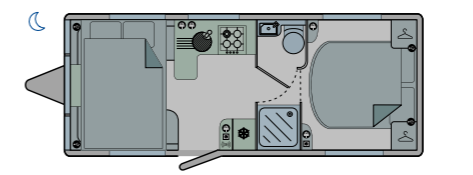
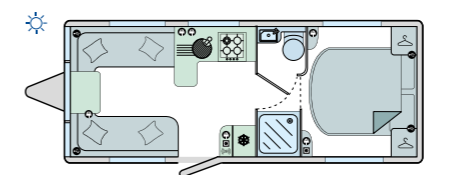

Bed Sizes

Front Double	2.12m x 1.13m / 7'0" x 3'9"
Front N/S Single	1.77m x 0.64m / 5'9" x 2'1"
Front O/S Single	1.74m x 0.64m / 5'8" x 2'1"
Rear Fixed Double	1.90m x 1.53m / 6'3" x 5'0"



Evora 4 ↑ Twin Axle

Internal Length	6.334m/20'9"
Shipping Length	7.862m/25'10"
Overall Width	2.450m/8'0"
Overall Height	2.605m/8'7"
Internal Headroom	1.960m/6'5"
Awning Size	1083cm
Tyre Sizes	185/65R14
MTPLM	1855kg
MRO	1694kg
Total User Payload	160kg

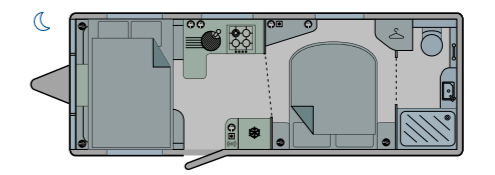
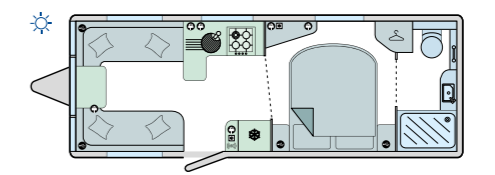

Bed Sizes

Front Double	2.12m x 1.21 / 7'0" x 4'0"
Front N/S Single	1.85 x 0.64m / 5'11" x 2'1"
Front O/S Single	1.82m x 0.64m / 5'11" x 2'1"
Rear Fixed Double	1.90m x 1.53m / 6'3" x 5'0"



Porto 4 ↑ Twin Axle

Internal Length	6.334m/20'9"
Shipping Length	7.862m/25'10"
Overall Width	2.450m/8'0"
Overall Height	2.605m/8'7"
Internal Headroom	1.960m/6'5"
Awning Size	1083cm
Tyre Sizes	185/65 R14
MTPLM	1847kg
MRO	1687kg
Total User Payload	160kg

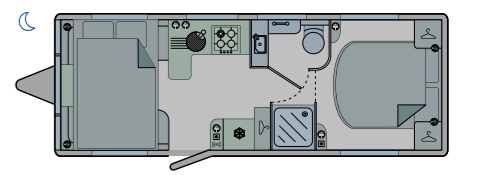
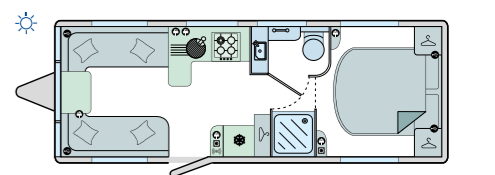

Bed Sizes

Front Double	2.12m x 1.21m / 7'0" x 4'0"
Front N/S Single	1.85m x 0.64m / 6'0" x 2'1"
Front O/S Single	1.82m x 0.64m / 5'11" x 2'1"
Rear Fixed Double	1.90m x 1.53m / 6'3" x 5'0"

A tolerance in the MRO has been allowed for in the calculations of Payload Margins. The awning length measurement shown is to be interpreted as a guide only and an enquiry should be made to individual awning manufacturers as to the correct size. Bed sizes are measured at the widest point of the bed.

PEGASUS
GRANDE GT75

Stylish & spacious

THE GRANDE TOURER



Get to know Pegasus Grande GT75

Grande style. Grande comfort. Grande adventures. The all new and improved Pegasus Grande GT75 will take your getaways to a whole new level.

Packed with features, the updated Pegasus Grande GT75 combines smart design and thoughtful touches, making it perfect for your next grand adventure.

6 Models

4-6 Berths

8ft

WIDE

Favourite facts

- Six spacious layouts for up to 6 people
- AL-KO ATC trailer control system and stabiliser hitch
- Large through-boot exterior storage locker (model specific)
- Media station with wireless charger and portable SONOS speaker
- Optional upholstery in Amersham Aquaclean fabric
- Stylish cashmere feature finish throughout
- Lightweight 8ft wide designs for comfortable touring
- Truma 100-watt flexible solar panel for off-grid holidays
- Four season all weather sustainability with Truma Combi blown air heating system
- Luxurious king size bed (model specific)
- Thetford K-series combined oven, grill and hob and electric hotplate
- New high security door lock with window

8ft Touring Caravan

Pegasus Grande GT75

Key features

- 1 Vertical front skylight surround with integral task lighting
- 2 Directional spotlights with USB charging points
- 3 Two-drawer front chest with slide out occasional table and soft close drawers (model specific)
- 4 Optional Aquaclean 'Amersham' upholstery (cost option)
- 5 Dual finish Italian design overhead curved locker doors with chrome contrasting stripe
- 6 Bailey 'Light Oak' furniture with new complimentary 'Cashmere' furniture finishes
- 7 GT75 Media Station with portable SONOS speaker and wireless charging capabilities
- 8 'Warm grey marble' kitchen worktop and splashback



Scan to see the full range



Model Portofino



Model Amalfi



Model | Bologna



Scan to find your nearest retailer

- 1 Full width washroom mirror (model specific)
- 2 Washroom with 'Warm Grey marble' splashback and Belfast style sink
- 3 Gloss white fully lined shower cubicle with riser bar



Model | Ancona

- 4 Truma Combi heating system, with user friendly digital control panel
- 5 Thetford 'K-series' combined oven, grill and hob with electric hotplate and three gas burners
- 6 GT75 portable SONOS speaker
- 7 Fixed double corner bed and bunk beds
- 8 Dedicated bedside table
- 9 L-shape lounge with freestanding table (model specific)

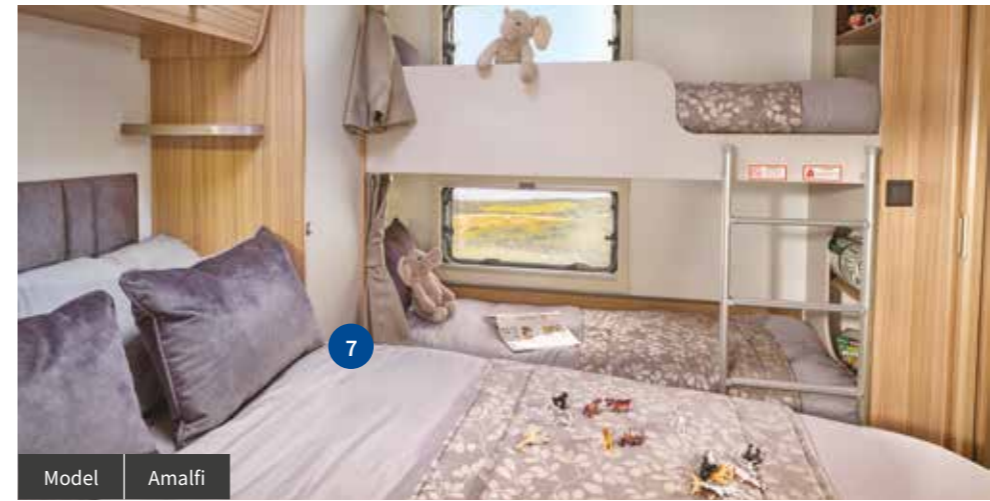

Model | Amalfi



Model | Ancona



Model | Bologna



Model | Brindisi



Model | Bologna



Model | Portofino



Model Portofino



Model Brindisi



Model Bologna

- 1 GT75 Media Station with portable SONOS speaker and wireless charging capabilities
- 2 Vanity unit with storage and mirror
- 3 Large wardrobe with full length mirror



Scan to see the full range



Brindisi	4 ↑
Internal Length	5.912m/19'5"
Shipping Length	7.378m/24'3"
Overall Width	2.450m/8'0"
Overall Height	2.608m/8'7"
Internal Headroom	1.960m/6'5"
Awning Size	1030cm
Tyre Sizes	195/70R15
MTPLM	1520kg
MRO	1365kg
Total User Payload	155kg

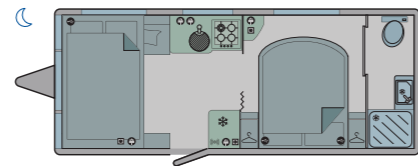
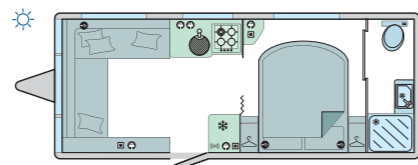

Bed Sizes	
Front Double	1.350m x 1.920m/4'5" x 6'4"
Front O/S Single	1.825m x 0.640m/6'0" x 2'1"
Rear Fixed Double	1.910m x 1.540m/6'3" x 5'1"

A tolerance in the MRO has been allowed for in the calculations of Payload Margins. The awning length measurement shown is to be interpreted as a guide only and an enquiry should be made to individual awning manufacturers as to the correct size. All Single Axle in 1600kg chassis. All Twin Axle in 1800kg chassis. Bed sizes are measured at the widest point of the bed.



Portofino	4 ↑
Internal Length	5.994m/19'8"
Shipping Length	7.378m/24'3"
Overall Width	2.450m/8'0"
Overall Height	2.608m/8'7"
Internal Headroom	1.960m/6'5"
Awning Size	1030cm
Tyre Sizes	195/70R15
MTPLM	1574kg
MRO	1419kg
Total User Payload	155kg

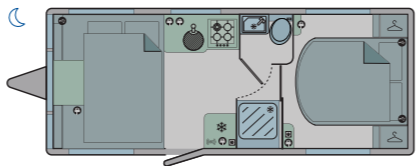
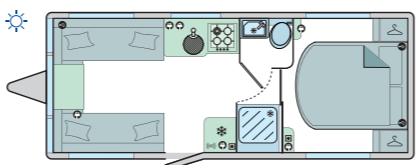

Bed Sizes	
Front Double	1.350m x 2.120m/4'5" x 6'11"
Front N/S Single	0.620m x 1.830m/2'0" x 6'0"
Front O/S Single	0.620m x 1.830m/2'0" x 6'0"
Rear Fixed Double	1.910m x 1.540m/6'3" x 5'1"



Ancona	5 ↑
Internal Length	6.016m/19'9"
Shipping Length	7.378m/24'2"
Overall Width	2.450m/8'0"
Overall Height	2.608m/8'7"
Internal Headroom	1.960m/6'5"
Awning Size	1030cm
Tyre Sizes	185/65R14
MTPLM	1579kg
MRO	1414kg
Total User Payload	186kg

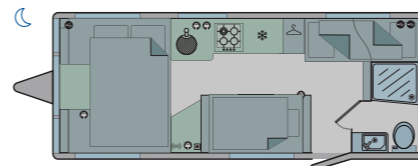
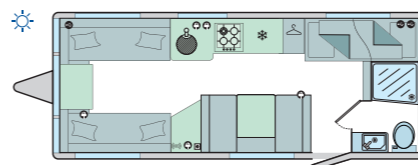

Bed Sizes	
Front Double	1.460m x 2.120m/4'9" x 6'11"
Front N/S Single	0.620m x 1.910m/2'0" x 6'3"
Front O/S Single	0.620m x 1.910m/2'0" x 6'3"
Bunk Bed	1.860m x 0.680m/6'1" x 2'3"
Dinette Bed	1.830m x 0.953m/6'0" x 3'2"



Bologna	4 ↑	Twin Axle
Internal Length	6.334m/20'9"	
Shipping Length	7.863m/25'10"	
Overall Width	2.450m/8'0"	
Overall Height	2.583m/8'6"	
Internal Headroom	1.960m/6'5"	
Awning Size	1077cm	
Tyre Sizes	185/65R14	
MTPLM	1669kg	
MRO	1509kg	
Total User Payload	160kg	

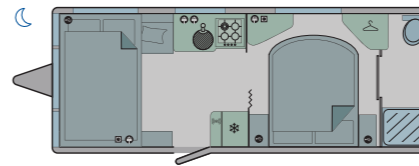
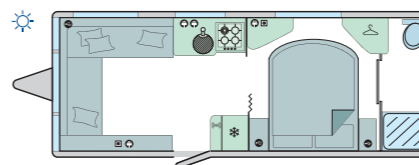

Bed Sizes	
Front Double	1.350m x 1.920m/4'5" x 6'4"
Front O/S Single	1.715m x 0.640m/5'8" x 2'1"
Rear Fixed Double	1.910m x 1.540m/6'3" x 5'1"



Messina	4 ↑	Twin Axle
Internal Length	6.334m/20'9"	
Shipping Length	7.863m/25'10"	
Overall Width	2.450m/8'0"	
Overall Height	2.583m/8'6"	
Internal Headroom	1.960m/6'5"	
Awning Size	1077cm	
Tyre Sizes	185/65R14	
MTPLM	1708kg	
MRO	1548kg	
Total User Payload	160kg	

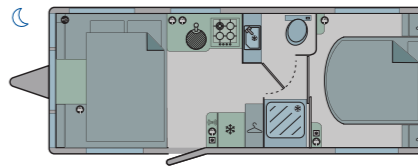
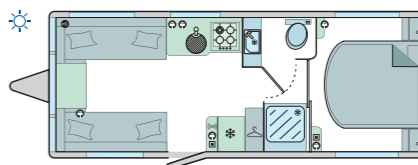

Bed Sizes	
Front Double	1.430m x 2.120m/4'8" x 6'11"
Front N/S Single	0.620m x 1.910m/2'0" x 6'3"
Front O/S Single	0.620m x 1.910m/2'0" x 6'3"
Rear Fixed Double	1.910m x 1.540m/6'3" x 5'1"



Amalfi	6 ↑	Twin Axle
Internal Length	6.334m/20'9"	
Shipping Length	7.863m/25'10"	
Overall Width	2.450m/8'0"	
Overall Height	2.583m/8'6"	
Internal Headroom	1.960m/6'5"	
Awning Size	1077cm	
Tyre Sizes	185/65R14	
MTPLM	1750kg	
MRO	1570kg	
Total User Payload	230kg	

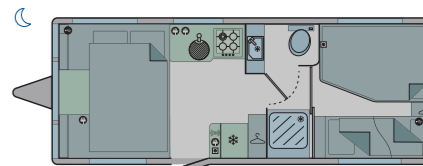
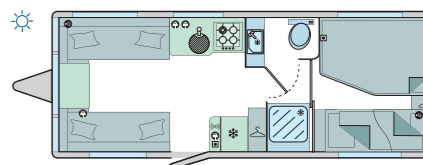

Bed Sizes	
Front Double	1.430m x 2.120m/4'8" x 6'11"
Front N/S Single	0.620m x 1.910m/2'0" x 6'3"
Front O/S Single	0.620m x 1.910m/2'0" x 6'3"
Rear Fixed Double	1.900m x 1.260m/6'3" x 4'2"
Bunk Bed	0.590m x 1.830m/1'11" x 6'0"

FREE-STYLE LUXURY



Get to know Unicorn

Our Unicorn range has become a firm favourite with the luxury market owner and this new fifth-generation Unicorn is no exception.

Its specification ticks all the practicality boxes, as well as new stylish features; complete with a choice of two luxurious soft furnishing schemes. If that wasn't enough, the Unicorn offers an unmissable new look front exterior infinity window. Wherever you want to travel, look no further than the new Unicorn to travel in the height of luxury.

[7 Models](#)[2-4 Berths](#)

Favourite facts

- Vertical infinity front window – with a 50% increase on window size
- AL-KO ATC trailer control system and stabiliser hitch
- Tracker Monitor system with integral intruder alarm and AL-KO secure wheel lock for extra security
- Truma 100 watt flexible solar panel for off-grid holidays
- External mains electrics and BBQ points
- Large through-boot exterior storage locker (model specific)
- Four season all weather sustainability with Alde radiator central heating system
- Wider fixed beds with superior foam mattress construction (model specific)
- Twin axle models with Dometic 153 litre fridge freezer with dual hinged door
- Branded 700 watt integrated microwave oven with non-moving ceramic hot plate

Key features

- 1 Vertical front infinity window and moulded surround with integral task lighting and speakers
- 2 Streamline front corner lockers
- 3 Dual finish 'Satin Cashmere' British design overhead curved locker doors with 'Light Oak' contrasting stripe
- 4 Standard 'Chiswick' soft furnishings
- 5 Two-drawer front chest with slide out occasional table and soft close drawers
- 6 Conventional sprung cushion construction with knee roll base cushions and back rests, featuring premium quality fabrics
- 7 Bailey 'Light Oak' furniture finish



Model | Vigo



Model | Vigo



Scan to see the full range



- 1
- 2



Scan to find your nearest retailer

- 1 Backlit washroom mirror (model specific)
- 2 Large fully lined square shower cubicle with bi-fold partition door and integral lighting
- 3 Drop down kitchen worktop extension (model specific)



- 3
- 4
- 5
- 6

- 4 Drop down hob cover worktop
- 5 Thetford dual fuel hob with electric hotplate and three gas burners
- 6 Branded 700 watt integrated microwave oven with non-moving ceramic hot plate
- 7 Bespoke caravan bedding sets to co-ordinate with caravan soft furnishings (cost option)
- 8 Optional 'Temple' soft furnishings

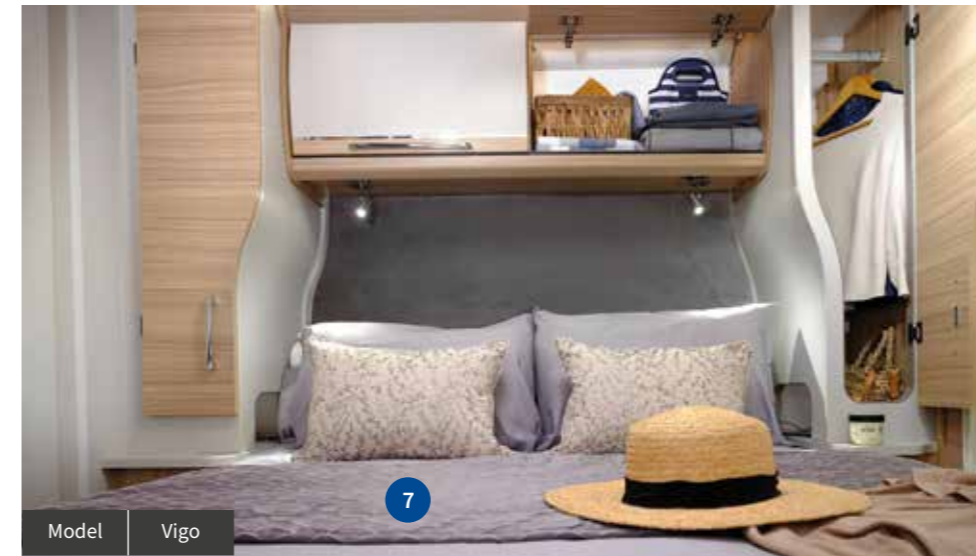

- 7



- 8





Seville	2 ↑
Internal Length	5.214m/17'1"
Shipping Length	6.474m/21'3"
Overall Width	2.264m/7'5"
Overall Height	2.669m/8'9"
Internal Headroom	1.960m/6'5"
Awning Size	944cm
Tyre Sizes	195/70R15C
MTPLM	1415kg
MRO	1289kg
Total User Payload	126kg

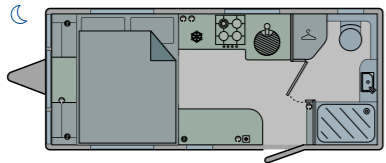
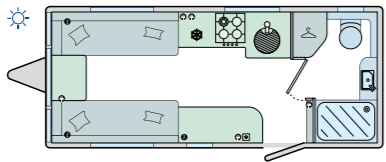

Bed Sizes	
Front Double	1.93m x 1.52m/6'4" x 4'11"
Front N/S Single	1.95m x 0.63m/6'5" x 2'1"
Front O/S Single	1.95m x 0.63m/6'5" x 2'1"



Madrid	4 ↑
Internal Length	5.667m/18'7"
Shipping Length	6.881m/22'7"
Overall Width	2.264m/7'5"
Overall Height	2.669m/8'9"
Internal Headroom	1.960m/6'5"
Awning Size	1003cm
Tyre Sizes	195/70R15C
MTPLM	1500kg
MRO	1348kg
Total User Payload	152kg

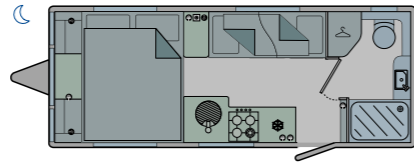
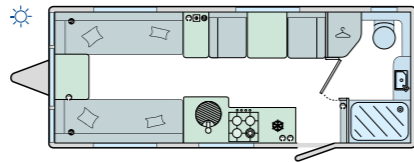

Bed Sizes	
Front Double	1.93m x 1.52m/6'4" x 4'11"
Front N/S Single	1.95m x 0.63m/6'5" x 2'1"
Front O/S Single	1.95m x 0.63m/6'5" x 2'1"
Rear O/S Single	1.83m x 0.64m/6'0" x 2'1"
Rear O/S Fold-out Bunk	1.79m x 0.60m/5'10" x 1'11"



Cadiz	4 ↑
Internal Length	6.067m/19'11"
Shipping Length	7.340m/24'1"
Overall Width	2.264m/7'5"
Overall Height	2.669m/8'9"
Internal Headroom	1.960m/6'5"
Awning Size	1023cm
Tyre Sizes	195/70R15C
MTPLM	1600kg
MRO	1423kg
Total User Payload	177kg

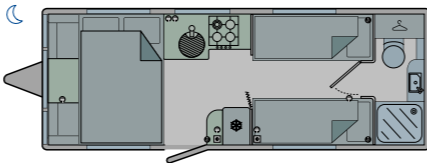
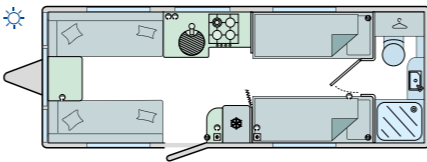

Bed Sizes	
Front Double	1.93m x 1.31m/6'4" x 4'3"
Front N/S Single	1.75m x 0.63m/5'9" x 2'1"
Front O/S Single	1.75m x 0.63m/5'9" x 2'1"
Rear N/S Fixed Single	1.95m x 0.74m/6'4" x 2'5"
Rear O/S Fixed Single	1.95m x 0.74m/6'4" x 2'5"



Vigo	4 ↑
Internal Length	6.067m/19'11"
Shipping Length	7.340m/24'1"
Overall Width	2.264m/7'5"
Overall Height	2.669m/8'9"
Internal Headroom	1.960m/6'5"
Awning Size	1023cm
Tyre Sizes	195/70R15C
MTPLM	1600kg
MRO	1430kg
Total User Payload	170kg

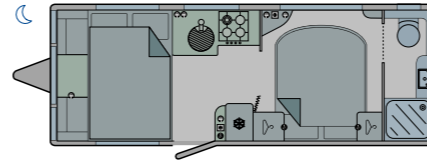
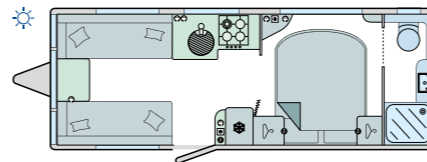

Bed Sizes	
Front Double	1.93m x 1.31m/6'4" x 4'3"
Front N/S Single	1.75m x 0.63m/5'9" x 2'1"
Front O/S Single	1.75m x 0.63m/5'9" x 2'1"
Rear Fixed Double	1.90m x 1.44m/6'3" x 4'9"



Cabrera	4 ↑
Internal Length	6.067m/19'11"
Shipping Length	7.340m/24'1"
Overall Width	2.264m/7'5"
Overall Height	2.669m/8'9"
Internal Headroom	1.960m/6'5"
Awning Size	1023cm
Tyre Sizes	195/70R15C
MTPLM	1600kg
MRO	1439kg
Total User Payload	161kg

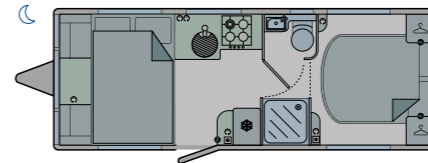
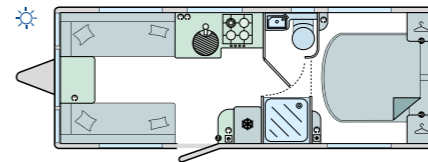

Bed Sizes	
Front Double	1.93m x 1.31m/6'4" x 4'3"
Front N/S Single	1.75m x 0.63m/5'9" x 2'1"
Front O/S Single	1.75m x 0.63m/5'9" x 2'1"
Rear Fixed Double	1.90m x 1.44m/6'3" x 4'9"



Cartagena	4 ↑	Twin Axle
Internal Length	6.379m/20'11"	
Shipping Length	7.815m/25'8"	
Overall Width	2.264m/7'5"	
Overall Height	2.669m/8'9"	
Internal Headroom	1.960m/6'5"	
Awning Size	1076cm	
Tyre Sizes	185/65R14	
MTPLM	1725kg	
MRO	1566kg	
Total User Payload	159kg	

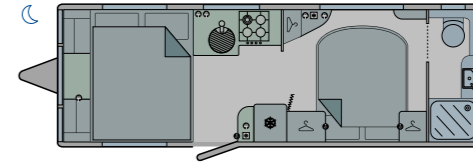
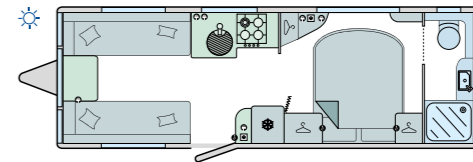

Bed Sizes	
Front Double	1.93m x 1.52m/6'4" x 4'11"
Front N/S Single	1.95m x 0.63m/6'5" x 2'1"
Front O/S Single	1.95m x 0.63m/6'5" x 2'1"
Rear Fixed Double	1.90m x 1.44m/6'3" x 4'9"



Pamplona	4 ↑	Twin Axle
Internal Length	6.379m/20'11"	
Shipping Length	7.815m/25'8"	
Overall Width	2.264m/7'5"	
Overall Height	2.669m/8'9"	
Internal Headroom	1.960m/6'5"	
Awning Size	1076cm	
Tyre Sizes	185/65R14	
MTPLM	1755kg	
MRO	1596kg	
Total User Payload	159kg	

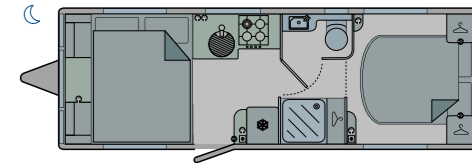
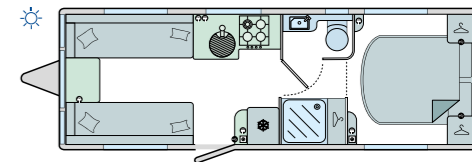

Bed Sizes	
Front Double	1.93m x 1.52m/6'4" x 4'11"
Front N/S Single	1.95m x 0.63m/6'5" x 2'1"
Front O/S Single	1.95m x 0.63m/6'5" x 2'1"
Rear Fixed Double	1.90m x 1.44m/6'3" x 4'9"



Scan to see the full range

A tolerance in the MRO has been allowed for in the calculations of Payload Margins. The awning length measurement shown is to be interpreted as a guide only and an enquiry should be made to individual awning manufacturers as to the correct size. All Single Axle in 1600kg chassis. All Twin Axle in 1800kg chassis. Bed sizes are measured at the widest point of the bed.

PHOENIX GT75

Comfortable & capable



READY FOR MORE?

Get to know Phoenix GT75

Phoenix GT75 now has models from two to six berths, so there's plenty of choice to meet your needs – and it makes joining the Bailey family more accessible than ever.

Inside and out, Phoenix GT75 gives you more of what you love – more space, more comfort, more style – all in a robust and lightweight four-season package. Wherever you choose for your next adventure, Phoenix GT75 is the perfect base.

6 Models

2-6 Berths

Favourite facts

- Six comfortable layouts for up to 6 people
- Spacious yet lightweight design accessible to a wide range of tow vehicles
- AL-KO stabiliser hitch and TUV tested 14" alloy wheels for added security
- Four season all weather sustainability with Truma Combi blown air heating system
- Light and airy interiors featuring a vertical opening front skylight
- Media station with wireless charger, portable SONOS speaker and a TV point
- Thoughtful selection of 230v power sockets and USB points
- Thetford K-Series combined oven, grill and 4 gas hob
- Dometic 103 litre refrigerator and 12 litre freezer
- Branded 650 watt microwave oven with non-moving ceramic hot plate

Key features

- 1 Vertical front skylight
- 2 'Hatton' soft furnishings with coordinating curtains and two scatter cushions
- 3 Two drawer front chest with slide out occasional table and soft close drawers
- 4 New front window surround
- 5 Domestic style sofa with fully sprung base cushions for enhanced comfort, featuring premium quality fabrics
- 6 Bespoke caravan bedding sets to co-ordinate with caravan soft furnishings (cost option)
- 7 Italian design overhead curved locker doors with dual chrome profiles



Scan to see the full range





Model 762



Scan to find your nearest retailer

- 1 Belfast style sink and mixer tap with a warm grey marble splashback
- 2 Fixed bunks both fitted with directional spotlights and USB points (model specific)

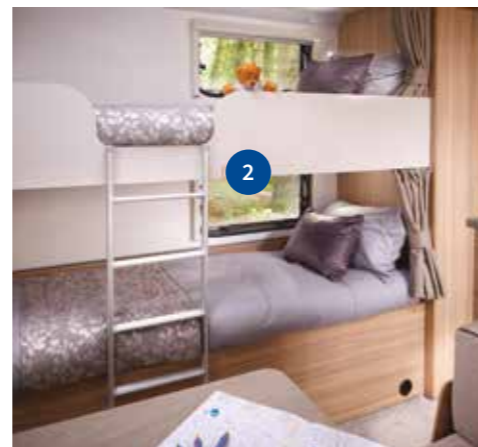

Model 640

- 3 'Amersham' optional aquaclean upholstery
- 4 GT75 media unit, with portable SONOS speaker and wireless charging capabilities
- 5 'Cashmere' locker door and microwave surrounds
- 6 Italian design overhead curved locker doors with dual chrome profiles
- 7 Free standing table



Model 642



Model 440



Model 420

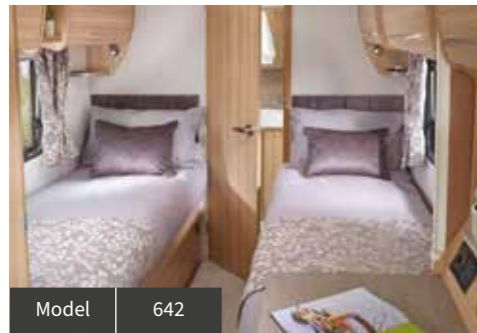

Model 642

Model 420



Scan to see the full range



420 **2 ↑**

Internal Length	4.032m/13'2"
Shipping Length	5.564m/18'3"
Overall Width	2.212m/7'3"
Overall Height	2.610m/8'7"
Internal Headroom	1.960m/6'5"
Awning Size	857cm
Tyre Sizes	195/70 R14 96N
MTPLM	1142kg
MRO	1025kg
Total User Payload	117kg

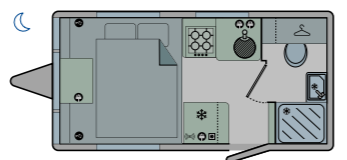
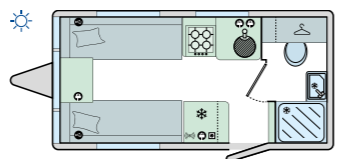

Bed Sizes

Front Double	1.45m x 1.87m/4'9" x 6'2"
Front N/S Single	1.92m x 0.615m/6'4" x 2'0"
Front O/S Single	1.92m x 0.615m/6'4" x 2'0"



440 **4 ↑**

Internal Length	5.351m/17'7"
Shipping Length	6.883m/22'7"
Overall Width	2.212m/7'3"
Overall Height	2.610m/8'7"
Internal Headroom	1.960m/6'5"
Awning Size	995cm
Tyre Sizes	185/80 R14 104N
MTPLM	1370kg
MRO	1220kg
Total User Payload	150kg

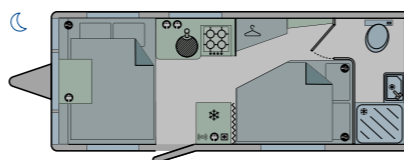
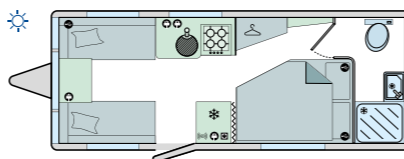

Bed Sizes

Front Double	1.04m x 1.87m/3'5" x 6'2"
Front N/S Single	1.55m x 0.615m/5'1" x 2'0"
Front O/S Single	1.55m x 0.615m/5'1" x 2'0"
Rear Fixed Double	1.32m x 1.90m/4'4" x 6'3"



642 **4 ↑**

Internal Length	5.841m/19'2"
Shipping Length	7.370m/24'2"
Overall Width	2.212m/7'3"
Overall Height	2.610m/8'7"
Internal Headroom	1.960m/6'5"
Awning Size	1035cm
Tyre Sizes	185/80 R14 104N
MTPLM	1433kg
MRO	1278kg
Total User Payload	155kg

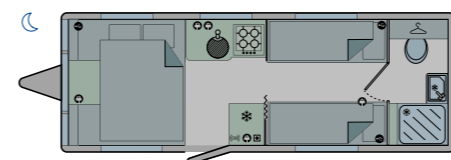
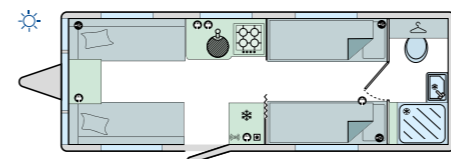

Bed Sizes

Front Double	1.30m x 1.87m/4'3" x 6'2"
Front N/S Single	1.80m x 0.615m/5'11" x 2'0"
Front O/S Single	1.80m x 0.615m/5'11" x 2'0"
Rear N/S Fixed Single	1.90m x 0.71m/6'3" x 2'4"
Rear O/S Fixed Single	1.90m x 0.71m/6'3" x 2'4"



644 **4 ↑**

Internal Length	5.841m/19'2"
Shipping Length	7.370m/24'2"
Overall Width	2.212m/7'3"
Overall Height	2.610m/8'7"
Internal Headroom	1.960m/6'5"
Awning Size	1035cm
Tyre Sizes	185/80 R14 104N
MTPLM	1426kg
MRO	1271kg
Total User Payload	155kg

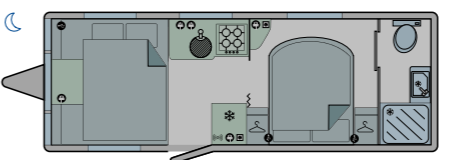
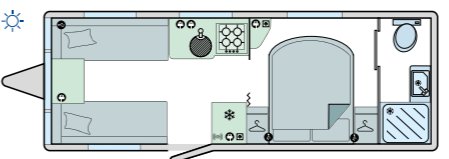

Bed Sizes

Front Double	1.30m x 1.87m/4'3" x 6'2"
Front N/S Single	1.80m x 0.615m/5'11" x 2'0"
Front O/S Single	1.80m x 0.615m/5'11" x 2'0"
Rear Fixed Double	1.72m x 1.355m/5'8" x 4'5"



640 **4 ↑**

Internal Length	5.841m/19'2"
Shipping Length	7.370m/24'2"
Overall Width	2.212m/7'3"
Overall Height	2.610m/8'7"
Internal Headroom	1.960m/6'5"
Awning Size	1035cm
Tyre Sizes	185/80 R14 104N
MTPLM	1436kg
MRO	1281kg
Total User Payload	155kg

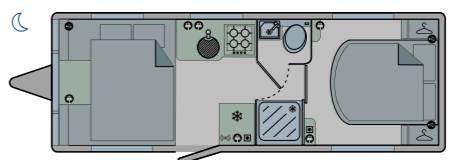
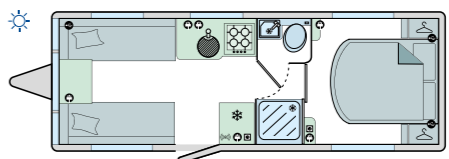

Bed Sizes

Front Double	1.30m x 1.87m/4'3" x 6'2"
Front N/S Single	1.80m x 0.615m/5'11" x 2'0"
Front O/S Single	1.80m x 0.615m/5'11" x 2'0"
Rear Fixed Double	1.72m x 1.355m/5'8" x 4'5"



762 **6 ↑** Twin Axle

Internal Length	6.605m/21'8"
Shipping Length	7.864m/25'10"
Overall Width	2.212m/7'3"
Overall Height	2.610m/8'7"
Internal Headroom	1.960m/6'5"
Awning Size	1077cm
Tyre Sizes	185/65 R14 93N
MTPLM	1636kg
MRO	1456kg
Total User Payload	180kg

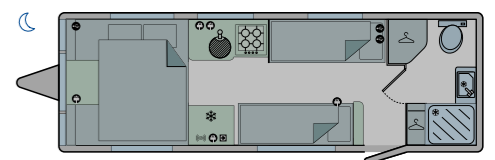
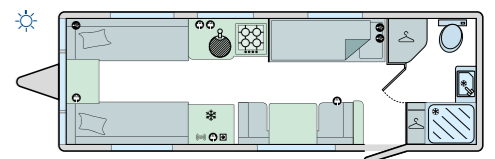

Bed Sizes

Front Double	1.30m x 1.87m/4'3" x 6'2"
Front N/S Single	1.92m x 0.615m/6'4" x 2'0"
Front O/S Single	1.92m x 0.615m/6'4" x 2'0"
Rear O/S Fold-out Bunk	1.73m x 0.66m/5'8" x 2'2"
Bunk Bed	1.86m x 0.68m/6'1" x 2'3" (x2)

A tolerance in the MRO has been allowed for in the calculations of Payload Margins. The awning length measurement shown is to be interpreted as a guide only and an enquiry should be made to individual awning manufacturers as to the correct size. Bed sizes are measured at the widest point of the bed.



Compact & confident



WHERE ADVENTURE BEGINS...

Get to know Discovery

Discovery takes adventuring to a whole new place. Its size means flexibility and get-up-and-go are built in: Discovery is ready to hit the road whenever you are.

Step inside and a compact exterior reveals a spacious interior. Across three models, contemporary styling blends seamlessly with practical design features, from innovative use of space and all-weather versatility, to premium fixtures and furnishings, and the Bailey signature vertical opening front skylight.

3 Models

2-4 Berths

Favourite facts

- Unique Alu-Tech wrap around bodysell profile for improved aerodynamics
- AL-KO stabiliser hitch and TUV tested alloy wheels for added stability
- Four season all weather sustainability with Truma combi blown air heating system
- Light and airy interiors featuring a vertical opening front skylight
- Contemporary styling featuring contrasting furniture finishes
- Thetford Triplex combination oven, grill and 3 burner hob
- Dometic 98 litre refrigerator
- Cleverly designed washroom includes an on-board shower
- Exclusive accessories available including Thule bike rack fitted to front A-frame or Thule wind-out awning (optional extras)

Key features

- 1 Front vertical opening skylight
- 2 'Satin Cashmere' matt overhead locker doors with contrast edging and over-locker LED lighting
- 3 'Apollo' soft furnishings with two scatter cushions
- 4 Bespoke caravan bedding sets to co-ordinate with caravan soft furnishings (cost option)

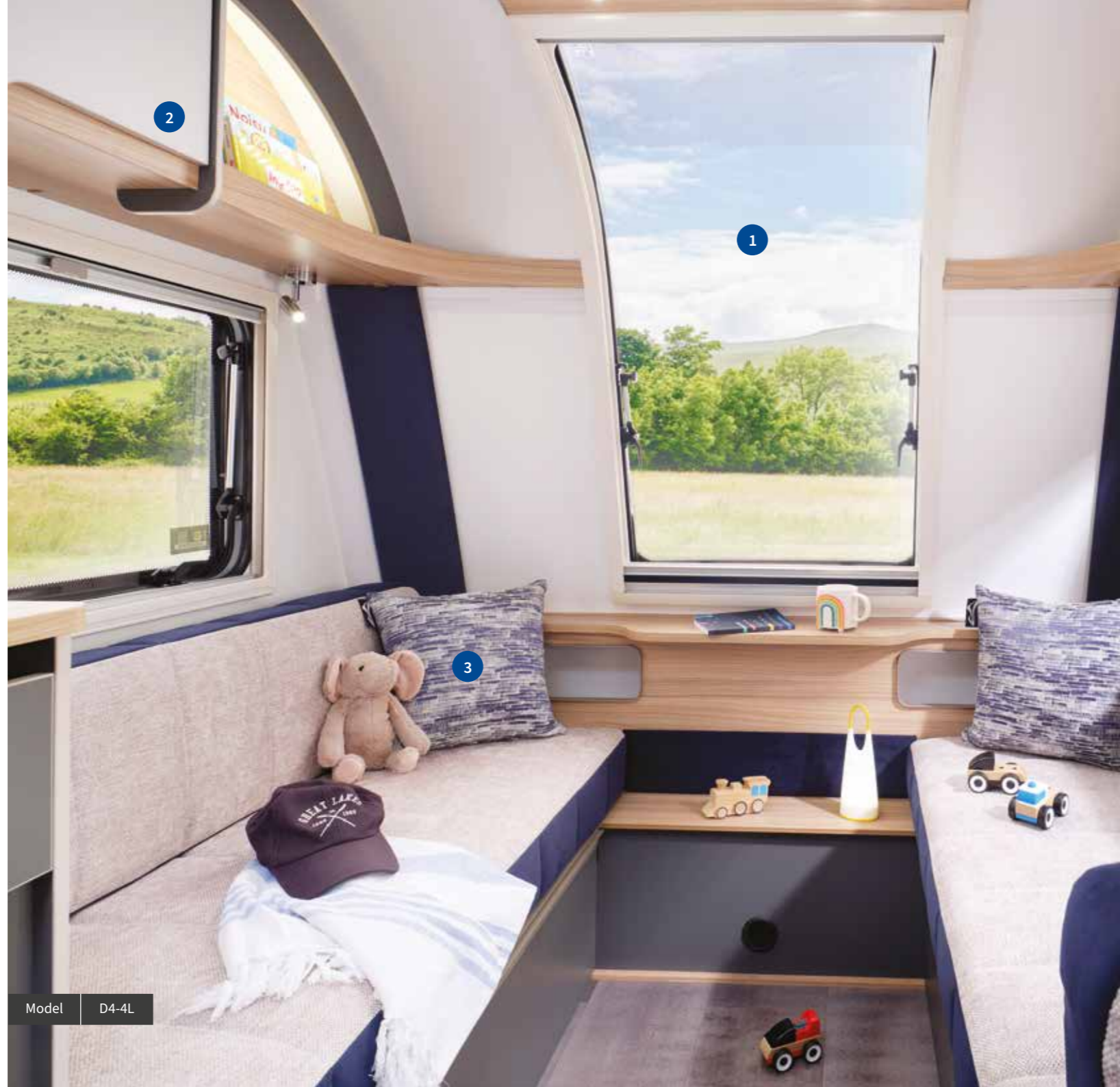

Model D4-4L



Model D4-4



Scan to see the full range

- 1 Dropdown kitchen worktop extension (optional extra)
- 2 Thetford Triplex combination oven and grill with three gas burner hob
- 3 Dedicated cutlery drawer
- 4 Belfast style washroom hand basin and mixer tap
- 5 Inboard shower unit with ceramic ball mixer tap, Ecocamel shower head and riser bar
- 6 Side dinette with fold-out pull-up bunk beds
- 7 Domestic style sofa seating featuring premium quality fabrics, sprung base cushions and foam back rests

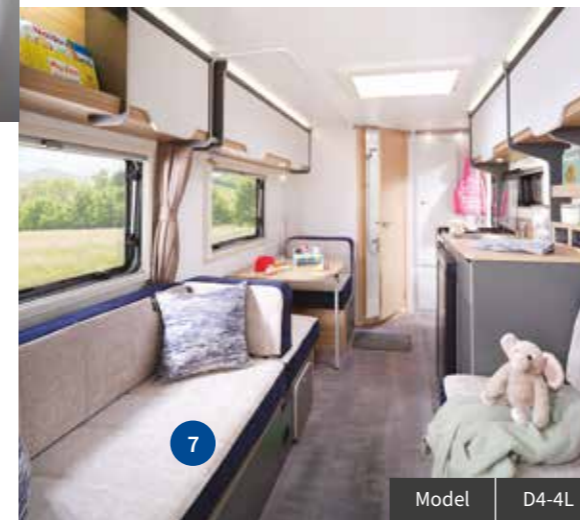
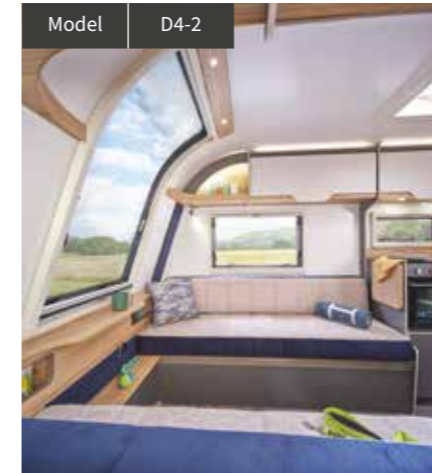
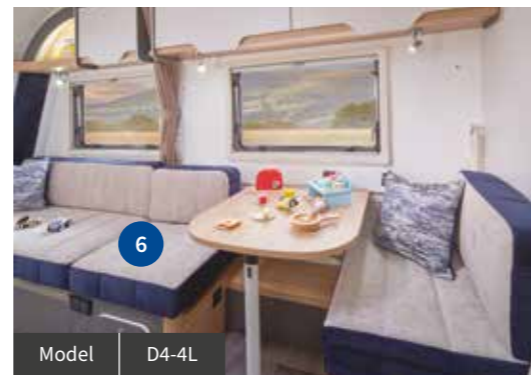
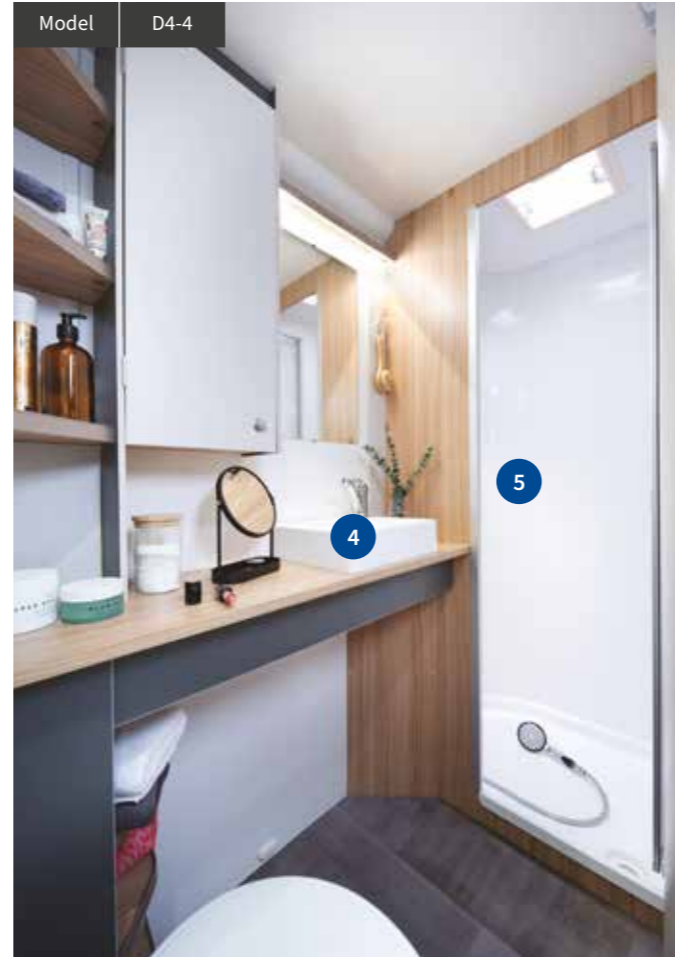

D4-2	2 ↑
Internal Length	3.76m/12'4"
Shipping Length	5.615m/18'5"
Overall Width	2.228m/7'4"
Overall Height	2.605m/8'6"
Internal Headroom	1.960m/6'5"
Tyre Sizes	185 R14C
MTPLM	998kg
MRO	887kg
Total User Payload	111kg

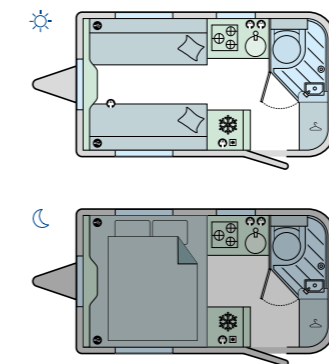

Bed Sizes	
Front Double	1.88m x 1.88m/6'2" x 6'2"
Front N/S Single	1.88m x 0.62m/6'2" x 2'0"
Front O/S Single	1.88m x 0.62m/6'2" x 2'0"



D4-4L	4 ↑
Internal Length	4.17m/13'8"
Shipping Length	5.922m/19'5"
Overall Width	2.228m/7'4"
Overall Height	2.605m/8'6"
Internal Headroom	1.960m/6'5"
Tyre Sizes	185 R14C
MTPLM	1082kg
MRO	949kg
Total User Payload	133kg

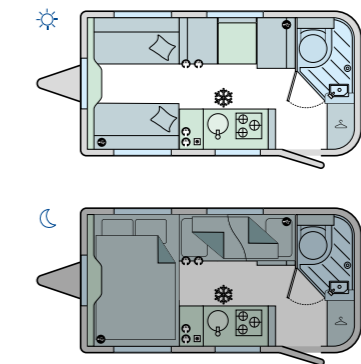

Bed Sizes	
Front Double	1.88m x 1.35m/6'2" x 4'5"
Front N/S Single	1.35m x 0.62m/4'5" x 2'0"
Front O/S Single	1.35m x 0.62m/4'5" x 2'0"
Rear O/S single	1.84m x 0.74m/6'0" x 2'5"
Rear O/S Fold-out bunk	1.73m x 0.62m/5'8" x 2'0"



D4-4	4 ↑
Internal Length	5.31m/17'5"
Shipping Length	7.149m/23'5"
Overall Width	2.228m/7'4"
Overall Height	2.605m/8'6"
Internal Headroom	1.960m/6'5"
Tyre Sizes	185 R14C
MTPLM	1248kg
MRO	1102kg
Total User Payload	146kg

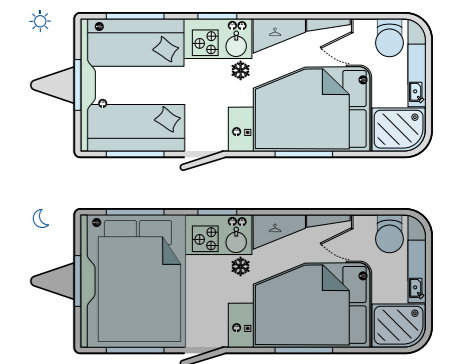

Bed Sizes	
Front Double	1.88m x 1.53m/6'2" x 5'0"
Front N/S Single	1.53m x 0.62m/5'0" x 2'0"
Front O/S Single	1.53m x 0.62m/5'0" x 2'0"
Rear Fixed Double	1.90m x 1.32m/6'3" x 4'4"

A tolerance in the MRO has been allowed for in the calculations of Payload Margins. The awning length measurement shown is to be interpreted as a guide only and an enquiry should be made to individual awning manufacturers as to the correct size. All Single Axle in 1600kg chassis. All Twin Axle in 1800kg chassis. Bed sizes are measured at the widest point of the bed.



Scan to find your nearest retailer

Where to buy your Bailey

The next step is to find out a little bit more. We have a network of approved Retailers across the country, who we choose to work with because of their expertise. And, like us, they love to get out there and Go Bailey! themselves.

Once you've found your Retailer, you can explore the ranges and models first-hand, along with pre-owned Bailey caravans,* and find out which one is 'the one'. The Retailer will be on-hand to guide you through your decision and will be happy to talk through finance options, if you need them. Scan the QR code below to find your nearest retailer.

The Bailey warranty

Your new Bailey comes with the peace of mind of our manufacturer's warranty. Your caravan's bodyshell is covered with a six-year integrity warranty, while other parts and components are covered for up to three years.**



*Subject to availability.
**Terms and conditions apply. Please refer to baileyofbristol.co.uk for more details.

JOIN THE CLUB



Once you're out on the road with your Bailey, you're already part of an exclusive club. So why not go one step further and join the real thing?

The Bailey Owners Club is here to help you get the most from your Bailey caravan or motorhome. Completely independent from Bailey of Bristol, there are members all over the world – and there's even a 'Little Bees' club for younger caravanners.

Membership is full of benefits. You'll be invited to weekend events and rallies across the UK, often at exclusive venues, while enjoying discounts on longer holidays in the UK and abroad – as well as online discounts at PRIMA Leisure, of course. You'll even have the chance to come and tour the Bailey factory, and meet the people behind Bailey.

Scan the QR code below for more information regarding the Bailey Owners Club.





The home of Bailey Parts

Exceptional aftercare and accessories

Once you're the proud owner of a Bailey caravan, you want to get the best out of it. Whether you need a replacement part, a must-have luxury, or upgrading to the latest tech, make PRIMA Leisure your first stop for all things Bailey.

As part of the Bailey family, the PRIMA team of experts is proud to offer first-class aftercare service and advice to Bailey owners across the UK.

With over 30,000 original parts and accessories available at the click of a button, PRIMA is here to help you 'Go Bailey'!



Browse the PRIMA website

30,000

Products available to browse



Shop 24 hours a day 7 days a week



Bailey experts on-hand to help



Deliver directly to you while on holiday (UK only)



Genuine OEM parts and quality accessories



Join our community



baileyofbristol.co.uk



This brochure does not constitute an offer by Bailey Caravans Ltd (Bailey). Bailey reserves the right to alter specifications and prices as market and supply conditions demand. Your Bailey Retailer will confirm all specification details prior to you making your purchasing decision. E. & O. E. Bailey Retailers sell our products of their own choice and not as agents of Bailey. Accordingly they have no authority to bind Bailey or to make any representation or undertaking whatsoever on behalf of Bailey. All household items illustrated in this brochure are used to enhance photography and are for display purposes only. They are not supplied with your touring caravan. Photographic colour reproduction is subject to the limitations of the production process.
Printed February 2024.

Designed and produced by: **saintnicks**

Photography: Alan Bond

Photography locations:

Alicanto Grande: Cheddar Mendip Heights Camping and Caravanning Club Site

www.campingandcaravanningclub.co.uk

Pegasus Grande GT75: Three Cliffs Bay, Gower, Wales
www.threecliffsbay.com

Unicorn: Little Meadow Campsite, Watermouth, Ilfracombe, Devon
www.littlemeadow.co.uk

Phoenix GT75: Cannock Chase, Rugeley Staffordshire
www.campingandcaravanningclub.co.uk/campsites/uk/staffordshire/rugeley/

Discovery: Pwllyn Farm Camping, Libanus, Powys