



GO WITH  
THE NATION'S  
FAVOURITE



Motorhomes 2024





# WHERE NEXT?



## Welcome to Bailey, The Nation's Favourite.

We've been proudly hitting the road for over 75 years. Along the way, we've built hundreds of thousands of Bailey caravans and motorhomes, each of them made with one thing in mind: creating the perfect holiday.

So, no matter which of our models you choose for your home away from home, comfort, convenience and adventure are built into every one.

**GO BAILEY!** We can't wait to see you out there.

### Contents

|                     |    |                    |    |
|---------------------|----|--------------------|----|
| Bailey heritage     | 02 | Adamo              | 10 |
| Sustainability      | 03 | Alora              | 18 |
| Made in Bristol     | 04 | Where to buy       | 26 |
| Tested to the limit | 06 | Bailey Owners Club | 27 |
| Ford Convertor      | 08 | PRIMA accessories  | 28 |
| Choose your Bailey  | 09 |                    |    |



## Bailey by name...

The Bailey story started back in 1947, when Martin Bailey designed and built the very first Bailey caravan in South Bristol. A year later in 1948, F G Bailey Ltd was formed and their caravans captured the nation's growing quest for adventure. Bailey quickly grew into the thriving, family-run business it still is today.

We've come a long way since those early days, but even with 75 years of experience now behind us, we have never stopped considering how we can push the boundaries and make our business better. And, like you, we continue to look towards to our next adventure...

To learn more about our history and heritage, visit our '75 Years and Counting' page on the Bailey website or scan the QR below.

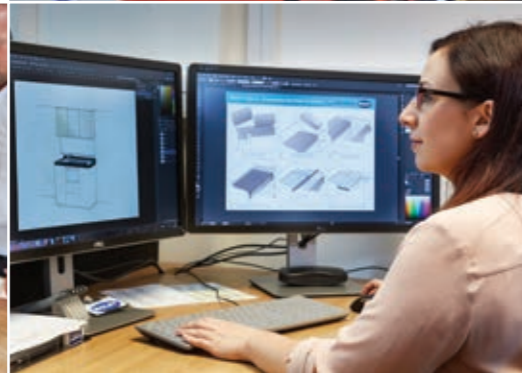

## Our road to sustainability

Caravans and motorhomes have long provided environmentally friendly holidays for people who have an appreciation for the great outdoors and who want to see it remain protected.

At Bailey, we remain committed to playing our part in this process by reducing the environmental footprint of our operations and striving to make our leisure vehicle products as sustainable as possible. Over recent years we have undertaken a range of initiatives designed to reduce our impact on the environment, covering our products, our sites and our culture.

In 2022 we signed up to the Woodland Trust Woodland Carbon Scheme to help reduce the environmental impact of our operations and at the same time boost biodiversity through the planting of trees. Consequently, when customers now purchase new Bailey caravans or motorhomes, we are planting trees to help offset the carbon emissions generated when we manufacture them.

To learn more about this and the other changes we are making to become a greener business visit the Sustainable Manufacturing page on our website or scan the QR code below.





## Made in Bristol

We've been proud to call South Bristol home since 1948. Martin Bailey designed and built the first Bailey caravan, just a stone's throw from the South Liberty Lane site that now houses our 14.5-acre production facility.

We think of ourselves as one big family. Most of us live nearby and have been part of Bailey for a long time (ten years is the average length of service).

From our joiners and electricians to our designers and fabricators, we have the skills, expertise and experience to build a complex range of caravans and motorhomes, all in the same plant – and all by hand.

For more information, head to our 'Manufacturing in Bristol' page on the Bailey site.



OVER  
500 HANDS  
HELP MAKE  
EVERY BAILEY



## What goes into The Nation's Favourite?

It all started with a simple question: "Is there a better way?"

Leisure vehicle design and construction was stagnant for over 30 years, until we developed Alu-Tech and changed everything. Alu-Tech is a completely new approach to bodyshell construction. Using a unique interlocking aluminium framework to clamp the body panels together, Bailey created a shell that is more robust and durable than anything else on the market.

By significantly reducing the number of external joints and fixing points and using timber-free components in the upper bodyshell panels, we are able to provide greater protection against the elements. Thicker, better-insulated panels, cloaked in impact resistant GRP (Glass Reinforced Plastic), hugely improve the thermal performance of the bodyshell, for genuine four-season performance. All this with no increase in weight or cost. Turns out there really is a better way.



**3 year** transferable manufacturer's components warranty\*  
**6 year** transferable bodyshell integrity warranty\*  
Access to aftercare team

\*Terms and conditions apply. Please visit [baileyofbristol.co.uk/warranties-servicing](http://baileyofbristol.co.uk/warranties-servicing) for more information.



Since Alu-Tech first hit the road ten years ago, we've built more than 75,000 leisure vehicles using Alu-Tech technology. To learn more about the unique features and benefits of Alu-Tech, head to the Bailey website.

- 1 Polystyrene core
- 2 Composite plastic extrusion
- 3 Alu-Tech rail
- 4 Structural fixing bracket
- 5 Alu-Tech rail insulation
- 6 GRP (Glass Reinforced Plastic) outer and inner skin

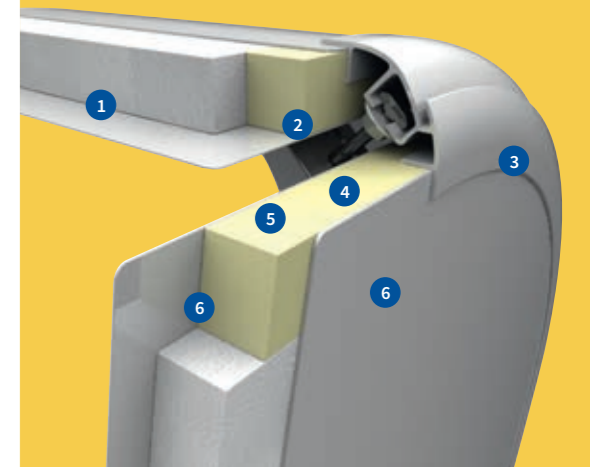



## Tested to the limit

From desert dust to Arctic ice, we put our motorhomes through their paces, so they're at their best on the roads of Great Britain – and beyond.

Good enough simply isn't good enough. It's why we go to extreme lengths to make sure our motorhomes can perform, whatever's thrown their way. It's only through rigorous testing that we're satisfied our products are ready for the road. Every new range goes through test conditions that push the limits of what a motorhome is likely to encounter in its lifetime.

Like our cold chamber testing, which goes down to -15°C to get the best possible results in thermal insulation with the help of our heating system partners.

If something's not up to the job, we go back to the drawing board until it is. That way, when our products hit the road, we know every single one is the best it can be.

See how else we take our testing to the limit on our website and learn more about our Bailey Big Adventures by scanning the QR code.



## Go anywhere, do everything

Cold chambers and test trucks are one thing, but few things beat getting out there properly.

In 2015, we took two caravans on a 3,500-mile journey through the Australian Outback. During the two-week trip, they stood up to everything the elements could throw at them, proving they could hold their own in even the toughest conditions.

In 2017, we embarked on another marathon endurance test; this time with two caravans and a motorhome, on a 5,000-mile trip to Northern Finland – and well inside the Arctic Circle. Conditions couldn't have been more different than the Red Centre of Australia, but once again the vehicles took everything in their stride.

The successes of these adventures really whet our appetite. So, we decided to embark on a third: 21 countries in 21 days, across two continents – without a rest. From Bristol to Istanbul, we're proud to say the vehicles were more than capable and eager for more – even if we were well in need of a break.

With our taste for adventure not quite satisfied, we hit the road hungry for more, and in 2023 completed our epic journey to the Sahara Desert. After our first attempt in 2020 was halted by the arrival of COVID-19, our successful journey to the Sahara and back proved the strength and endurance of Bailey vehicles once again.







The Ford Pro Convertor Programme recognises premium convertors across Europe that offer expertise and high-quality output at every stage of production. Bailey was the first UK manufacturer to be awarded Ford Pro Convertor status for coachbuilt motorhomes.

To obtain Ford Pro Convertor status, a manufacturer must be able to deliver high quality products that meet Ford's strict engineering, manufacturing and quality control standards, giving you even more peace of mind when choosing your dream Bailey motorhome.

The Ford Pro Convertor accreditation audit undertaken by Ford ensures that Bailey not only meets the required production standards but also offers a comprehensive customer support programme, which includes product performance data analysis and a warranty package comparable with that already provided on the Ford base vehicle.



4 Travel Seats



## ADAMO

p. 10

Smart & spirited

Adamo is the perfect companion to every adventure. Smart design meets seamless practicality across five endlessly flexible layouts for whatever you want to throw life's way.

Weight up to 3,500kg



4 Travel Seats



## ALORA

p. 18

Streamlined & striking

Slimline in shape and stylish in design, the Alora offers a bespoke and compact experience wherever you may find yourself. The world is your oyster, enjoy it from the comfort of the Alora.

Weight up to 3,500kg



## Choose your Bailey

You'll find a quick summary of each of the two ranges on this page, then you can explore the features of each in much more detail. Scan the relevant QR code to see the full range on our website.



# ADAMO

Smart & spirited

# GET UP AND GONE



## Get to know Adamo

Adamo is the perfect companion to every adventure. Smart design meets seamless practicality across five endlessly flexible layouts for whatever you want to throw life's way.

Cleverly designed to be as versatile as possible the Adamo range is ideal for a spontaneous escape or that long planned roadtrip.

5 models

4 travel seats

3,500kg chassis

### Favourite facts

- Three flexible layouts for up to eight people; all models have four travel seats
- Ford chassis and cab, with automatic transmission for easy driving
- External onboard garage space, to separate outdoor kit from living space
- Flexi-lounge configures to meet living needs: eat, sleep, or relax in front of the slide-out TV
- Electric-powered drop-down beds
- Four-season capability with Truma Combi 4 heating system and storage for 2 x 11kg refillable gas bottles
- 100w solar panel and leisure battery for true 'off-grid' adventures
- Fully equipped kitchen, with 3-ring gas hob, hot plate, separate grill and oven, and a bigger sink



Key features

- 1 Fully adjustable upholstered driver and passenger Captain's seats with twin upholstered armrests and integrated headrests
- 2 Flexi lounge featuring twin Aguti convertible travelling seats
- 3 Multi-directional and multi-angled slide out TV bracket (model specific)
- 4 Standard 'Odyssey' soft furnishings supplied with four scatter cushions



Model 75-4L

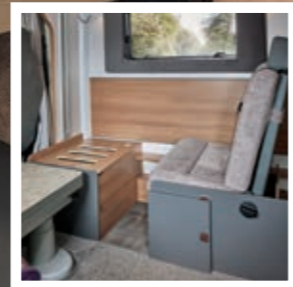

Scan to see the full range



Model 69-4



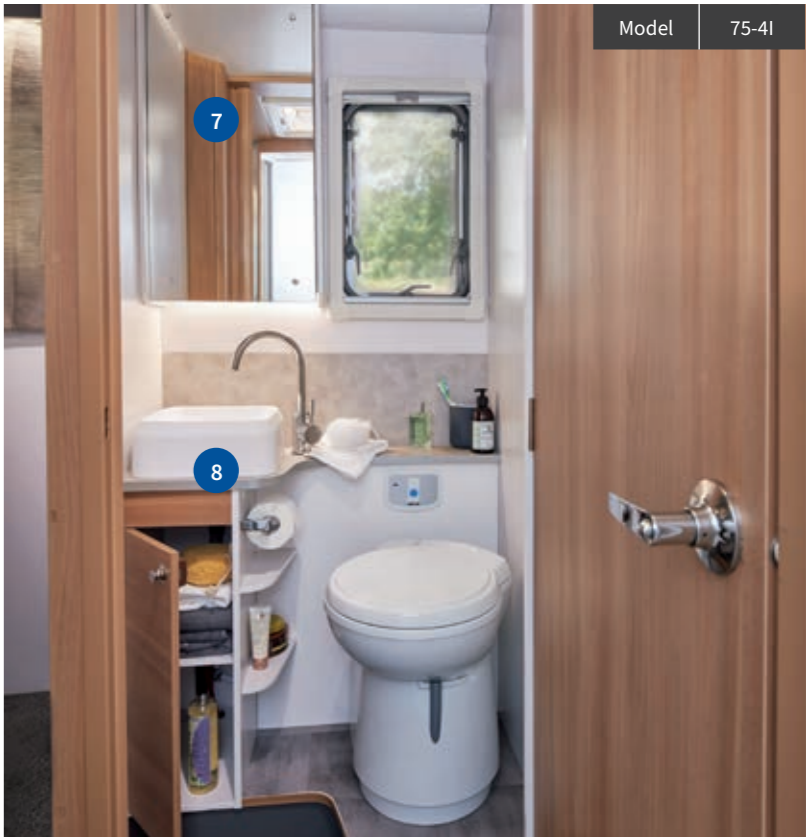

- 1 Drop down kitchen worktop extension
- 2 Thetford 'K-Series' combined oven, grill and hob with electronic ignition and flame failure device
- 3 Electrical pedestal table with multi directional swivel 'Nebula Silver' finish top and telescopic leg



Scan to find your nearest retailer

- 4 Rear lounge featuring domestic style sofa seating premium quality fabrics and high density foam filling (model specific)
- 5 Headboard with LED lighting strip (model specific)
- 6 Bespoke motorhome bedding set (cost option)
- 7 Vanity cupboard with mirrored door and toothbrush holder
- 8 Countertop mounted washroom hand basin with swan neck ceramic ball mixer tap

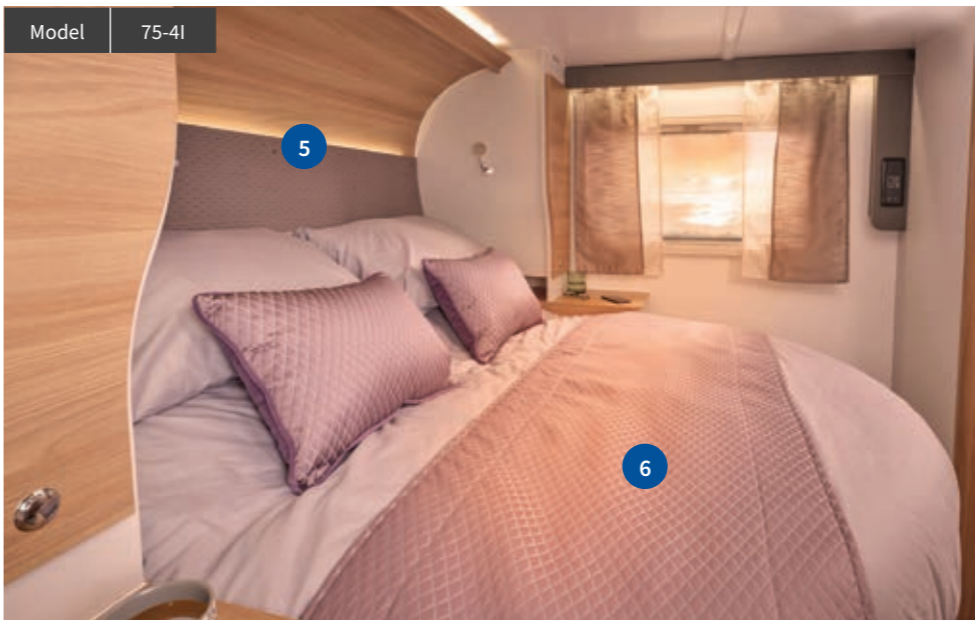
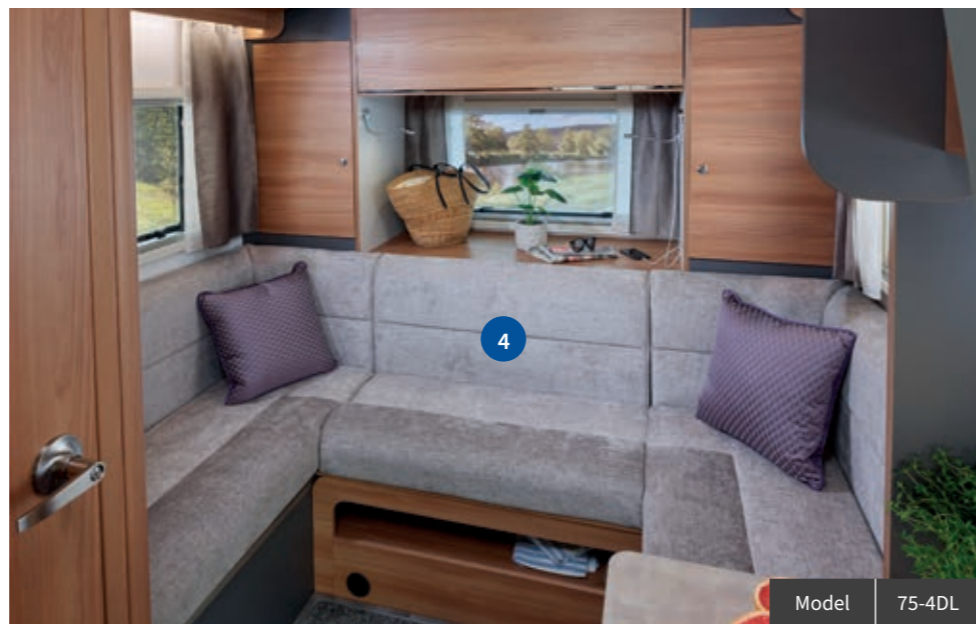



- 1 Ford 2.0 litre 160bhp engine with automatic gearbox
- 2 Hanging rail with drainage in garage for wet items (model specific)
- 3 Large garage exterior storage with 230v and 12v socket power supply, up to six lashing rings and heating outlet



Scan to see the full range



| 60-4                           | 4            |
|--------------------------------|--------------|
| Designated Travelling Seats    | 4            |
| Berths                         | 4            |
| Overall Body Length            | 6.099m/20'   |
| Overall Cab Width <sup>^</sup> | 2.379m/7'10" |
| Overall Habitation Width*      | 2.380m/7'10" |
| Overall Height                 | 2.849m/9'5"  |
| Tyre Sizes                     | 235/65R 16 C |
| MTPLM                          | 3500kg       |
| MRO                            | 2949kg       |
| Total User Payload             | 551kg        |

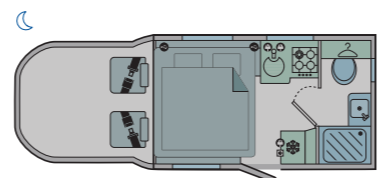
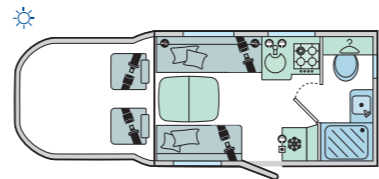

#### Bed Sizes

|                                     |                              |
|-------------------------------------|------------------------------|
| Front Double <sup>†</sup>           | 2.22m x 1.295m (7'3" x 4'3") |
| Front Drop Down Double <sup>†</sup> | 1.84m x 1.56m (6'1" x 5'1")  |



| 69-4                           | 4             |
|--------------------------------|---------------|
| Designated Travelling Seats    | 4             |
| Berths                         | 4             |
| Overall Body Length            | 6.987m/22'11" |
| Overall Cab Width <sup>^</sup> | 2.379m/7'10"  |
| Overall Habitation Width*      | 2.380m/7'10"  |
| Overall Height                 | 2.849m/9'4"   |
| Tyre Sizes                     | 235/65R 16 C  |
| MTPLM                          | 3500kg        |
| MRO                            | 3090kg        |
| Total User Payload             | 410kg         |

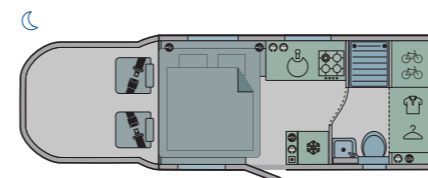
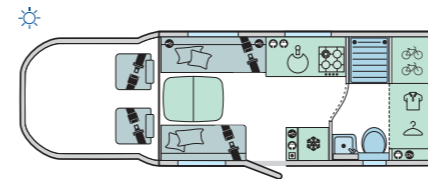

#### Bed Sizes

|                                     |                              |
|-------------------------------------|------------------------------|
| Front Double <sup>†</sup>           | 2.22m x 1.295m (7'3" x 4'3") |
| Front Drop Down Double <sup>†</sup> | 1.84m x 1.56m (6'1" x 5'1")  |



| 75-4I                          | 4            |
|--------------------------------|--------------|
| Designated Travelling Seats    | 4            |
| Berths                         | 4            |
| Overall Body Length            | 7.485m/24'7" |
| Overall Cab Width <sup>^</sup> | 2.379m/7'10" |
| Overall Habitation Width*      | 2.380m/7'10" |
| Overall Height                 | 2.849m/9'4"  |
| Tyre Sizes                     | 235/65R 16 C |
| MTPLM                          | 3500kg       |
| MRO                            | 3142kg       |
| Total User Payload             | 358kg        |

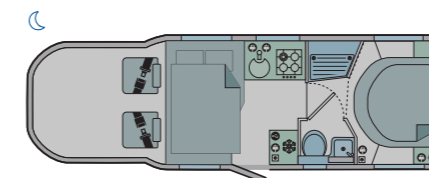
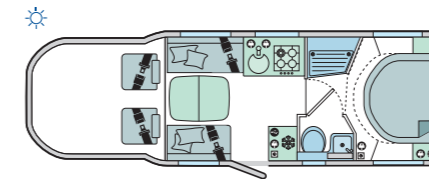

#### Bed Sizes

|                           |                               |
|---------------------------|-------------------------------|
| Front Double <sup>†</sup> | 2.22m x 1.205m (7'3" x 3'11") |
| Rear Double <sup>†</sup>  | 1.85m x 1.59m (6'1" x 5'3")   |



| 75-4T                          | 4            |
|--------------------------------|--------------|
| Designated Travelling Seats    | 4            |
| Berths                         | 4            |
| Overall Body Length            | 7.485m/24'7" |
| Overall Cab Width <sup>^</sup> | 2.379m/7'10" |
| Overall Habitation Width*      | 2.380m/7'10" |
| Overall Height                 | 2.849m/9'5"  |
| Tyre Sizes                     | 235/65R 16 C |
| MTPLM                          | 3500kg       |
| MRO                            | 3156kg       |
| Total User Payload             | 344kg        |

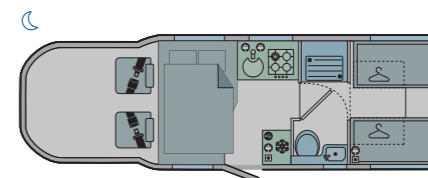
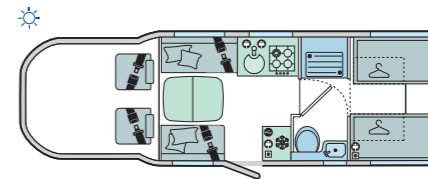

#### Bed Sizes

|                                    |                                |
|------------------------------------|--------------------------------|
| Front Double <sup>†</sup>          | 2.22m x 1.205m (7'3" x 3'11")  |
| Near Side Rear Single <sup>†</sup> | 1.85m x 0.839m (6'1" x 2'9")   |
| Off Side Rear Single <sup>†</sup>  | 1.815m x 0.805m (5'11" x 2'8") |



| 75-4DL                         | 4            |
|--------------------------------|--------------|
| Designated Travelling Seats    | 4            |
| Berths                         | 4            |
| Overall Body Length            | 7.485m/24'7" |
| Overall Cab Width <sup>^</sup> | 2.379m/7'10" |
| Overall Habitation Width*      | 2.380m/7'10" |
| Overall Height                 | 2.849m/9'4"  |
| Tyre Sizes                     | 235/65R 16 C |
| MTPLM                          | 3500kg       |
| MRO                            | 3160kg       |
| Total User Payload             | 340kg        |

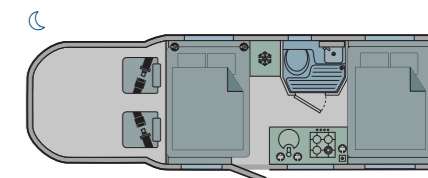
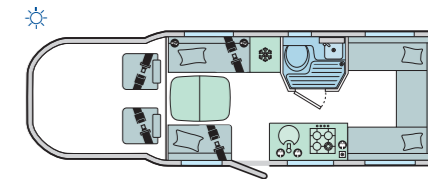

#### Bed Sizes

|                                     |                             |
|-------------------------------------|-----------------------------|
| Front Drop Down Double <sup>†</sup> | 1.84m x 1.35m (6'1" x 4'5") |
| Rear Drop Down Double <sup>†</sup>  | 1.84m x 1.35m (6'1" x 4'5") |

**Vehicle weights:** the MRO figure is the weight of the unladen motorhome plus an allowance for the driver, 90% of the fuel tank capacity and 'essential habitation equipment'. The MRO is declared with the fresh water tank empty (it is not recommended that you travel with water in the fresh water tank but if you chose to do so then your available payload will reduce accordingly). A tolerance of +/- 5% has also been allowed for in the calculation in the MRO figures.

**Vehicle measurements:** <sup>^</sup>Mirrors folded. <sup>\*</sup>Inc marker lights. Drop down double bed has a maximum load capacity of 200kg. <sup>†</sup>Measured from the widest point. Please refer to [baileyofofbristol.co.uk](http://baileyofofbristol.co.uk) for more information.



# ALORA

Streamlined & striking

# APRÈS- ADVENTURE



## Get to know Alora

Slimline in shape and stylish in design, the Alora offers a bespoke and compact experience wherever you may find yourself. The world is your oyster, enjoy it from the comfort of the Alora.

Packed with luxury features, this smart, streamlined design is easy to manoeuvre and filled with clever storage solutions, ideal for those wanting their adventures made seamless.

3 models

4 travel seats

3,500kg chassis

## Favourite facts

- Three stylish layouts for up to four people
- Streamlined bodyshell under 7ft wide
- Ford chassis and cab with high-performance 130bhp engine
- Fully specified cab with 12" touchscreen infotainment system, air conditioning and cruise control all as standard
- Smart storage solutions in and out including large storage drawers and onboard garage space
- Flexi-lounge configuration to meet travel and living needs with pop out travelling seats
- Four-season all-weather sustainability with Truma Diesel Combi D4E blown air heating and hot water system
- Fully equipped kitchen with Thetford 138 litre compressor fridge, 3-ring gas hob and hotplate and combination oven and grill
- Cleverly designed convertible washrooms featuring a space saving sliding sink unit



Key features

- 1 In-vehicle infotainment system featuring a 12" touchscreen display including sat nav
- 2 'Cosmos' soft furnishings supplied with two bolster cushions
- 3 'White Quartz' free standing table
- 4 High level over cab storage cubbies
- 5 Front flexi-lounge featuring twin Aguti convertible travelling seats incorporating ISOFIX with dedicated travel seat cushions



Model 69-4S



Scan to see the full range







- 1 User-friendly digital control panel
- 2 Thetford dual-fuel hob with electric hotplate and three gas burners
- 3 Drop-down kitchen worktop extension with a 'White Quartz' finish

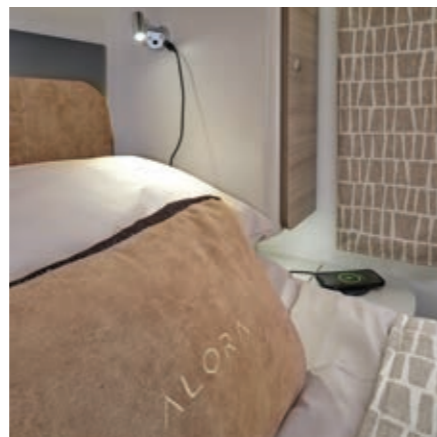

- 4 Twin beds with sprung beech slat bed bases for enhanced comfort
- 5 Integral storage between and underneath beds
- 6 Cleverly designed washroom featuring a space saving sliding tambour partition screen
- 7 Traverse rear bed and full width overhead storage (model specific)

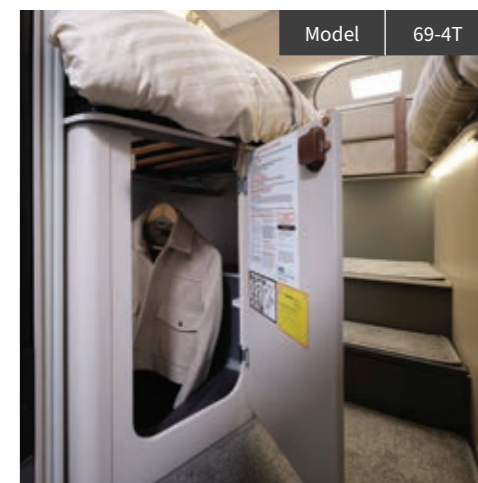
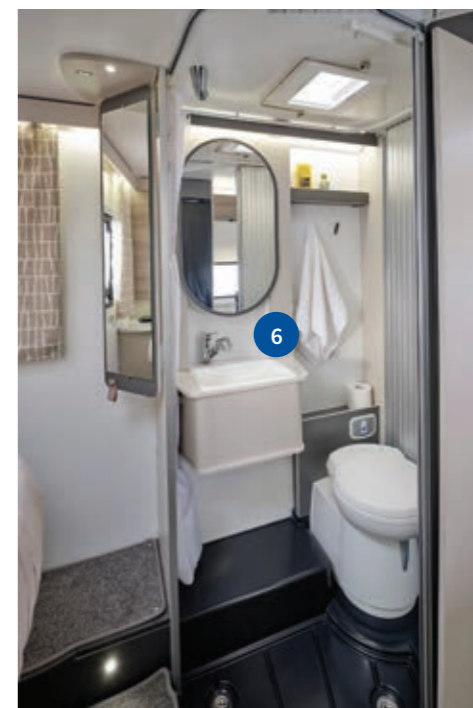

Scan to find your nearest retailer



- 1 Mini Heki rooflight with night blind and drop-down towel rail
- 2 Bedside storage shelves (model specific)
- 3 Fully lined spacious rear garage featuring up to four floor mounted lash rings, 230v and 12v power sockets and a blown air heating outlet

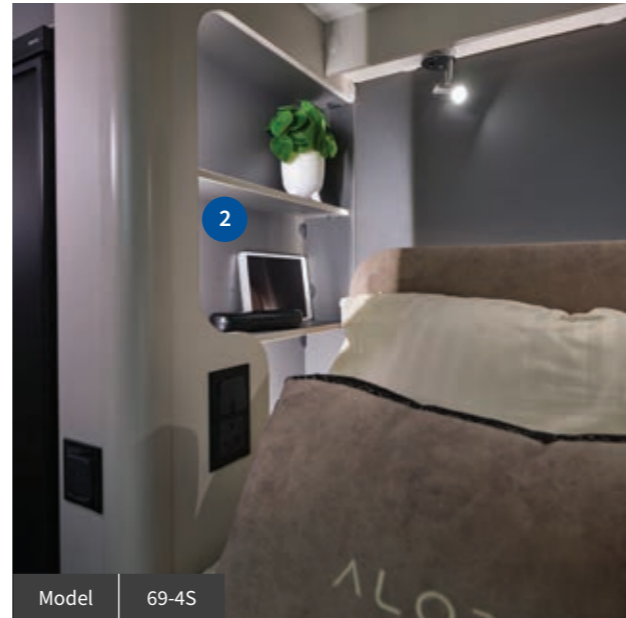

Model 69-4S



**69-4I**

4

|                             |              |
|-----------------------------|--------------|
| Designated Travelling Seats | 4            |
| Berths                      | 3            |
| Overall Body Length         | 6.99m/22'11" |
| Overall Cab Width*          | 2.12m/6'11"  |
| Overall Habitation Width*   | 1.99m/6'5"   |
| Overall Height              | 2.85m/9'4"   |
| Tyre Sizes                  | 235/65R 16C  |
| MTPLM                       | 3500kg       |
| MRO                         | 2965kg       |
| Total User Payload          | 535kg        |

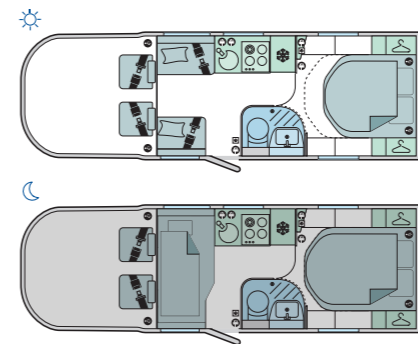

**Bed Sizes**

|                           |                             |
|---------------------------|-----------------------------|
| Front Single <sup>†</sup> | 1.96m x 0.99m (6'5" x 3'3") |
| Rear Double <sup>†</sup>  | 1.88m x 1.43m (6'2" x 4'8") |



**69-4S**

4

|                             |              |
|-----------------------------|--------------|
| Designated Travelling Seats | 4            |
| Berths                      | 4            |
| Overall Body Length         | 6.99m/22'11" |
| Overall Cab Width*          | 2.12m/6'11"  |
| Overall Habitation Width*   | 1.99m/6'5"   |
| Overall Height              | 2.85m/9'4"   |
| Tyre Sizes                  | 235/65R 16C  |
| MTPLM                       | 3500kg       |
| MRO                         | 2950kg       |
| Total User Payload          | 550kg        |

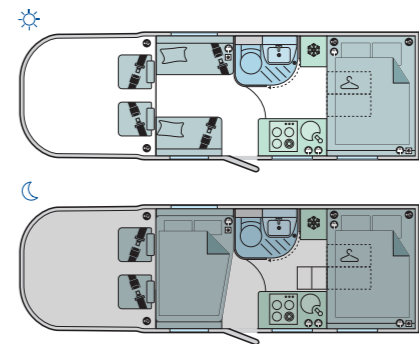

**Bed Sizes**

|                           |                              |
|---------------------------|------------------------------|
| Front Double <sup>†</sup> | 1.96m x 0.99m (6'5" x 3'3")  |
| Rear Double <sup>†</sup>  | 1.89m x 1.49m (6'2" x 4'11") |



**69-4T**

4

|                             |              |
|-----------------------------|--------------|
| Designated Travelling Seats | 4            |
| Berths                      | 3            |
| Overall Body Length         | 6.99m/22'11" |
| Overall Cab Width*          | 2.12m/6'11"  |
| Overall Habitation Width*   | 1.99m/6'5"   |
| Overall Height              | 2.85m/9'4"   |
| Tyre Sizes                  | 235/65R 16C  |
| MTPLM                       | 3500kg       |
| MRO                         | 2965kg       |
| Total User Payload          | 535kg        |

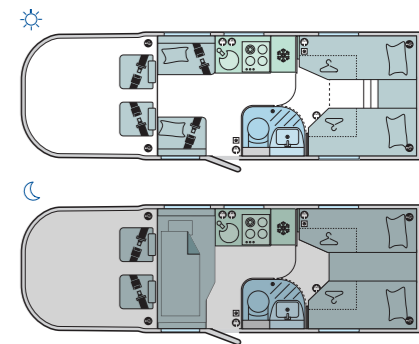

**Bed Sizes**

|                 |                             |
|-----------------|-----------------------------|
| Front Single    | 1.96m x 0.99m (6'5" x 3'3") |
| Rear N/S single | 1.85m x 0.74m (6'0" x 2'5") |
| Rear O/S single | 1.96m x 0.74m (6'5" x 2'5") |



Model 69-4S



1



Vehicle weights: the MRO figure is the weight of the unladen motorhome plus an allowance for the driver, 90% of the fuel tank capacity and 'essential habitation equipment'. The MRO is declared with the fresh water tank empty (it is not recommended that you travel with water in the fresh water tank but if you chose to do so then your available payload will reduce accordingly). A tolerance of +/- 5% has also been allowed for in the calculation in the MRO figures.  
 Vehicle measurements: \*Mirrors folded. †Inc marker lights. ‡Measured from the widest point. Please refer to baileyofbristol.co.uk for more information.



## Where to buy your Bailey

The next step is to find out a little bit more. We have a network of approved Retailers across the country, who we choose to work with because of their expertise. And, like us, they love to get out there and Go Bailey! themselves.

Once you've found your Retailer, you can explore the ranges and models first-hand, along with pre-owned Bailey motorhomes,\* and find out which one is 'the one'. The Retailer will be on-hand to guide you through your decision and will be happy to talk through finance options, if you need them. Scan the QR code below to find your nearest retailer.

### The Bailey warranty

Your new Bailey comes with the peace of mind of our manufacturer's warranty. Your caravan's bodyshell is covered with a six-year integrity warranty, while other parts and components are covered for up to three years.\*\*



\*Subject to availability.  
\*\*Terms and conditions apply. Please refer to baileyofbristol.co.uk for more details.



# JOIN THE CLUB



Once you're out on the road with your Bailey, you're already part of an exclusive club. So why not go one step further and join the real thing?

The Bailey Owners Club is here to help you get the most from your Bailey caravan or motorhome. Completely independent from Bailey of Bristol, there are members all over the world – and there's even a 'Little Bees' club for younger caravanners.

Membership is full of benefits. You'll be invited to weekend events and rallies across the UK, often at exclusive venues, while enjoying discounts on longer holidays in the UK and abroad – as well as online discounts at PRIMA Leisure, of course. You'll even have the chance to come and tour the Bailey factory, and meet the people behind Bailey.

Scan the QR code below for more information regarding the Bailey Owners Club.







The home of Bailey Parts

## Exceptional aftercare and accessories

Once you're the proud owner of a Bailey, you want to get the best out of it. Whether you need a replacement part, a must-have luxury, or upgrading to the latest tech, make PRIMA Leisure your first stop for all things Bailey.

As part of the Bailey family, the PRIMA team of experts is proud to offer first-class aftercare service and advice to Bailey owners across the UK.

With over 30,000 original parts and accessories available at the click of a button, PRIMA is here to help you 'Go Bailey'!



Browse the PRIMA website

|   |  |                                       |   |  |
|---|--|---------------------------------------|---|--|
| <p>30,000</p> <p>Products available to browse</p> | <p>Shop 24 hours a day 7 days a week</p> | <p>Bailey experts on-hand to help</p> | <p>Deliver directly to you while on holiday (UK only)</p> | <p>Genuine OEM parts and quality accessories</p> |
|---|--|---------------------------------------|---|--|





Join our community



[baileyofbristol.co.uk](http://baileyofbristol.co.uk)



This brochure does not constitute an offer by Bailey Caravans Ltd (Bailey). Bailey reserves the right to alter specifications and prices as market and supply conditions demand. Your Bailey retailer will confirm all specification details prior to you making your purchasing decision. E. & O. E. Bailey retailers sell our products of their own choice and not as agents of Bailey. Accordingly they have no authority to bind Bailey or to make any representation or undertaking whatsoever on behalf of Bailey. All household items illustrated in this brochure are used to enhance photography and are for display purposes only. They are not supplied with your motorhome. Photographic colour reproduction is subject to the limitations of the production process. Printed February 2024.

Designed and produced by: saintnicks

Photography: Alan Bond, Osprey Imagery

Photography locations:

Adamo: Lyndor CL, Hole-in-the-wall, Ross-on-Wye  
[www.lyndorcl.co.uk](http://www.lyndorcl.co.uk)

Alora: Caravan Park Sexten  
Via San Giuseppe 54, Sesto, 39030, Italy  
[www.caravanclub.co.uk/overseas/italy/caravan-park-sexten/](http://www.caravanclub.co.uk/overseas/italy/caravan-park-sexten/)