



PURSUIT

As Seen Bodyside
PEGASUS
GT65

UNICORN 

OWNERS MANUAL



YOUR NEW UNICORN CARAVAN IS TYREPAL TPMS READY!

Purchase the TyrePal OE Monitor Kit for a complete Tyre Pressure Monitoring System for your Caravan!

TyrePal OE Monitor Kits are available from any Bailey Caravan Dealership, Bailey Parts Direct or www.tyrepal.co.uk

Your TyrePal TC215B Monitor can also accommodate your spare wheels and towing vehicle's tyres.

Visit www.tyrepal.co.uk to purchase additional external sensors for this simple upgrade.

Visit www.tyrepal.co.uk for further information and TyrePal OE Monitor Kit content.



**NON TPMS READY CARAVANS,
YOU WILL NEED:**



TC215B + Sensors



TC215B + Sensors



Alde®

www.alde.co.uk

We didn't invent heating We Perfected it

43.1°C

Outside temperature is -25°C

*Inside temperature is +25°C**

13.1°C



Central Heating just like home

- VERY QUIET • ENVELOPING WARMTH • ELIMINATES DRAUGHTS
- EFFICIENT • LOW 12V POWER CONSUMPTION • EVEN HEAT DISTRIBUTION
- SCANDINAVIAN DURABILITY • COMFORTABLE ATMOSPHERE



Ask your dealer about
Alde Heating Systems today



*Heating performance dependent upon caravan design

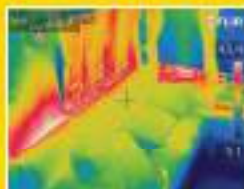
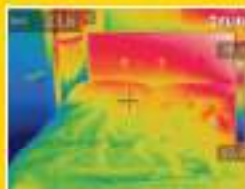



Free glossy monthly magazine

50% off selected sites mid-week and more



Fantastic ferry fares



The Caravan Club There's no better value in touring



Save £10 a night on pitch fees



Enjoy access to over 200 UK sites and 2,500 certificated locations



FREE technical help & advice

Discover our many sites on historic estates like Longleat



Exclusive member offers including M6 toll savings



Club Together our online community chat, interact, ask, review

Discover an unrivalled choice of sites and thousands of exclusive destinations, huge savings on everything from new cars and great days out to restaurant meals and show tickets plus a whole host of exclusive services and tailored insurance products. At only £44* The Caravan Club takes you and your money further.

What are you waiting for? Join today
www.caravanclub.co.uk/join or call 0800 3286 635

*Price valid until 14 December 2014. A joining fee of £10 applies – this fee is waived if you choose to pay by Direct Debit.



Model: _____

Vehicle Identification number V.I.N: _____
(Located on the exterior windows and chassis)

Owner's name: _____

Address: _____

Telephone number: _____

Habitation key number: _____

Retailer's name: _____

Retailer's address: _____

Telephone Number: _____

MTPLM: _____

Caravan Height: _____

Caravan Length: _____

GREAT

GUIDES

TO THE

GREAT OUTDOORS

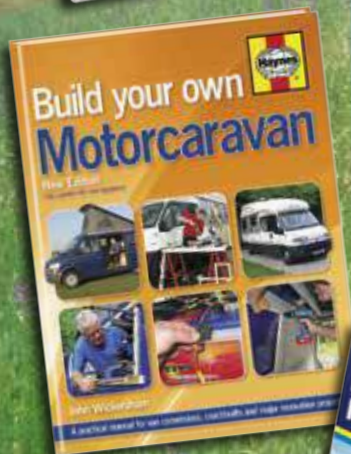

The Motorcaravan Manual

(3rd Edition)
ISBN: 978 0 85733 124 3
£21.99

Build Your Own Motorcaravan

(2nd Edition)
ISBN: 978 0 85733 281 3
£21.99

The Caravan Manual

ISBN: 978 1 84425 678 5
£21.99

Driving Abroad

ISBN: 978 1 84425 576 4
£12.99

Motorcaravanning Handbook

(2nd Edition)
ISBN: 978 0 8 5733 264 6
£14.99

Prices correct at the time of printing



Follow us on:



www.haynes.co.uk

Books for enthusiasts
by enthusiasts



Available from all good bookshops or ORDER DIRECT on Tel: 01963 442030

CONTENTS

1. INTRODUCTION	1		
• Driving Licences	2		
2. STATEMENT OF CONFORMITY	2		
3. WARRANTY	3		
• Touring Caravan Warranty Cover	3		
• 6 Year Bodyshell Integrity Guarantee	3		
• Warranty Extension	3		
• 3 Year Manufacturer's Warranty	3		
• Warranty Extension	4		
• Customer Support	4		
• Terms and Conditions	4		
• Cover	4		
• Term	4		
• Repairs	4		
• Registration and Use	5		
• Exclusions and Liability	5		
• Warranty Registration	6		
4. CENTRAL REGISTRATION AND IDENTIFICATION SCHEME (C.R.I.S)	6		
• CRIS Registrations:	7		
5. COUNTRY AND COASTAL CODE	8		
• Code of Conduct - Camp sites	8		
• Arrivals	8		
• Vehicle Movement	8		
• Use of Site	8		
• Cautions	8		
• Noise	8		
• Dogs and Pets	8		
• Fire Precautions	8		
• Awnings and Tents	8		
• Departure:	8		
• Handbook	9		
• Environment	9		
• The Country Code	9		
• The Coastal Code	9		
• Roof Loading	9		
• Safety and Security	9		
• Children	10		
• Fire Extinguishers	10		
• In Case of Fire	10		
• Ventilation and Condensation	10		
• Petrol and Diesel Fumes	10		
• Original Equipment Appliances	10		
• Portable Appliances	10		
• Modifications	10		
6. CARAVAN AND TOW VEHICLE	11		
• Caravan and Towing Vehicle Terms	11		
		• The caravan to towing vehicle weight ratio:	12
		• Kerb weight of towing vehicle	12
		• Towing Vehicle's Rear Suspension	12
		• Recommended Towball Height	12
		• Secondary Braking Cable (breakaway device)	12
		• Correct procedure for use:	13
		• Loading and Distribution of Weight in the Caravan and Car.	13
		• Hitching Up	14
		• Hitching the caravan to the tow vehicle	15
		7. TOWING	16
		• Speed Limits	16
		• Pulling Away	16
		• Caravan Handling	16
		• Reversing	16
		• Motorway Driving	16
		• Mirrors	16
		• Snaking	16
		• Stabilisers	16
		• Road Lighting	17
		8. ROAD LIGHTS	17
		9. UNHITCHING	19
		• Levelling the Caravan	20
		• Towing Brackets	20
		10. WHEELS AND TYRES	21
		• Unicorn and Pegasus	21
		• Pursuit	21
		• Wheel, Tyre and Bolt safety fitment by Wheel Solutions Ltd	21
		• WSL Safety Bolts.	21
		• Tyres	21
		• Tyre Wear and Damage	21
		• Tyre Pressures	21
		WHEELS AND TYRES	22
		• Wheels	22
		11. SPARE WHEEL CARRIER	23
		• Unicorn and Pegasus Models	23
		• To lower the spare wheel:	23
		• Returning the spare wheel to the storage compartment:	23
		• Pursuit Plus Models.	24
		12. THE AL-KO CARAVAN CHASSIS (AKS 3004)	25
		• Chassis Members	25
		• Independent Suspension	25

• Coupling Head	25	15. THE GAS SYSTEM	42
• Brake Drum/Hub Assembly	25	• General information	42
• Operating Instructions	26	• Types of gas	42
• Coupling	26	• Butane	42
• Stabiliser Unit	26	• Propane	42
• Uncoupling	26	• The Regulator	42
• Uncoupling	26	• Changing Gas Cylinder	43
• Manoeuvring Operation	27	• Gas Safety Advice	43
• Noises while driving	27	• Gas Leaks	43
• Remedial Action	27	• Ventilation	44
• Storing	28	• Gas BBQ point	44
• Towing Ball	28		
• Overrunning Device	28	16. THE ELECTRICAL SYSTEM-230v	45
• Jockey Wheel	28	• Instructions for electricity supply	45
• Brake Linkage	28	• On arrival at caravan site	45
• Corner Steadies	28	• On leaving caravan site	45
• Braking System Adjustment	28	• Generators	45
• Chassis Lubrication Points	30	• Overseas Connections	45
• AL-KO ATC Trailer Control System	30	• Mains Unit	46
• Operating Instructions	30		
• Spare Parts	31	17. THE ELECTRICAL SYSTEM- 12v	47
13. TRACKER RETRIEVE	32	• Auxilliary Battery Storage/Mains	
• What to Do in the Event of Theft?	32	Inlet	47
• General Questions	32	• Battery Box Connections	48
		• 12v and Pump Controls (Single	
14a. THE UNICORN III SINGLE		Axles)	49
AXLES AND PEGASUS		• Battery Voltage.	49
GT65 WATER SYSTEM	34	18. UNICORN III CONTROL PANELS	49
• Water Supply	34	THE PEGASUS GT65 CONTROL	
• Operation	34	PANEL	50
• Routine Maintenance:	35	• iVan Panel Operating Instructions	50
• Draining and Winterisation of the Water		• Operating the Space Heater	50
System	35	• Programming the Timer,	52
		• Space Heater Timer:	52
14b. UNICORN III TWIN		• Turning the Timer Off:	52
AXLE WATER SYSTEM	36	• Water Heater Timer:	52
• Water Supply	36	• Turning the Timer Off:	52
• External supply	36	• Quick Timer Settings:	52
• Operation	36	• Operating the Pump	53
• Filling the on-board tank	37	• Options	53
• Internal supply	37	• Menu	53
• Tank Drain Operation	38	• Functions	53
• Routine Maintenance	38	• Available Settings	53
• Draining and Winterisation of		• Troubleshooting	53
the Water System	38	• Space Heater Diagnostic Screens	53
• Helpful hints	39	• Check outside flues for blockages	54
• Water System Troubleshooting	39	• Water Heater Diagnostic Screens,	55
• Adjusting your Pressure Switch	40	• Winterising	56
		• Space Heater	56
14c. THE PURSUIT WATER SYSTEM	41	• Frost Protection	56
• Truma Ultraflow Instructions	41	• Water Heater	56
• Routine Maintenance	41	• Watermaster® Pump	56
• Sterilising	41		

THE PURSUIT CONTROL PANEL	57	• Maintenance	73
		• Troubleshooting	73
20. UNICORN SOLAR DUAL BATTERY CHARGER SDC 10/20	58	TRUMA COMBI 2 E UK	74
• Function	58	• COMBI 4 E / 6 E Version UK	74
• Charging process	58	• Function Description	75
• Bulk phase	58	• Winter Operation	75
• Absorption phase	59	• Summer Operation	75
• Float phase	59	• Operating Instructions	75
• Equalisation charging phase	59	• Room Thermostat	75
• Parallel mode	59	• Safety/Drain Valve (operational)	76
• Settings;	59	• Draining the Water Heater	76
• Operation	59	• Closing the Drain Valve	76
• Battery type	59	• Filling the Water Heater	76
• Charging current distribution	59	• Draining the Water Heater	77
• PWM charging frequency	60	• Methods of Operation	77
• Query	60	• Summer Operation	77
• PWM charging frequency	60	• Winter Operation	77
• Function display / Troubleshooting	60	• Heating with drained water system.	78
• Repairs	60	• Fault	78
20. HEATING SYSTEMS	62	• Gas Operation	78
• Operating Instructions:	62	• Electrical Operation	78
• Description of Functions	62	• Mixed Mode	79
• Gas Heating	62	• Maintenance	79
• Electric Heating	62	• Fuse 12v	79
• Domestic Hot Water	62	• Fuse 230v	79
• Draining Freshwater	64	• Overheating Protection 230v.	80
• Heat Transfer Fluid	64	Truma CP Plus Digital Control Panel	83
• Filling	64	• Operating Instructions	83
• Central Heating	65	• Safety instructions	83
• Circulation Pump	65	• Intended Use	83
• Bleeding Air	65	• Functions	83
• Air Lock	66	• Start/standby screen	84
• 230v Electric	66	• Switch on/return to setting level	84
• LPG	67	• Switch off	84
• Flue	67	• Change the room temperature	84
• Maintenance	67	• Change the warm water level	84
• Winter	68	• Select power type	85
• Troubleshooting	69	• Select fan level	85
• Warranty	70	• Heater Combi	85
3020 113 Colour Touch	70	• Enter start time	85
• Starting the System	70	• Set the room temperature	86
• Standby Screen	71	• Set the warm water level	86
• Main Menu	71	• Select fan level	86
• Desired Room Temperature	72	• Activate the timer (ON)	86
• Domestic Hot Water	72	• Deactivate the timer (OFF)	87
• Electric Heating	72	• Set time	87
• Gas Heating	72	• Service Menu	87
• Shutting Down the System	72	• Change language	87
• Setup	72	• Display mains voltage 230v	87
• Restore Default Factory Settings	72	• Read out the warning code	88
• Setup Expansion Tank Pump	72	• Malfunctions	88
• Set up Antimicrobial Function	73		
• Setup Standby Screen for Bedtime	73		

21. EXTERIOR FEATURES	91	• Positioning the Storage Racks	107
GRP	91	• Exchange of the Igniter Battery	107
ROOFLIGHTS	91	• Shutting off the Refrigerator	108
HEKI Rooflights	91	• Lighting	108
• Safety instructions:	92		
• Care instructions:	92		
MPK Rooflight	92		
22. COOKING EQUIPMENT	93	24b. Dometic Model RMD8551	108
The Caprice Cooker	93	• Cleaning	108
• Operation	93	• Operation	108
• Using the Hotplate Gas Burners	93	• Maintenance	108
• Using the Electric Hotplate	94	• Electrical Operation	109
• Using the Grill	94	• Additional Features	110
• Using the Oven	95	• Frame Heating	110
• Oven Temperature Control	95	• Door Locking	110
• Cooking Guidelines	95	• Positioning Storage Racks	111
• Do's and Don'ts	96	• Lighting	111
• Country Cooking Appliances	96	• Ice Cubes	111
• Operating Instructions	96	• Shutting off the Refrigerator	111
• The Linear Hob	96	• Defrosting	112
• The Midi Oven and Grill	97	• Winter Operation	112
• Oven	98	• Troubleshooting	112
• Temperature Control	98	• Maintenance	13
• Cooking Guidelines	98		
• Do's and Don'ts	99	24c. Dometic Model RML9330	114
• Maintenance and Servicing	99	• Introduction	114
• Service	99	• Warranty	114
		• Limitation of Liability	114
23. DAEWOO MICROWAVE OVEN	100	• Environmental notices	114
• Features:	100	• Energy Saving Tips	114
• Operation Procedure	101	• Declaration of Conformity	114
• Wattage Output	101	• Safety Instructions	115
• Controls	101	• User's responsibility	115
• Setting the Clock	101	• Information on Coolant	115
• Weight Defrosting	102	• Appliances with electronics	115
• Time Defrosting	102	• Operating with Gas	115
• Cooking in One Stage	102	• Operation	117
• Cooking in Two Stages	102	• Cleaning	117
• Easy Cooking	103	• Maintenance	117
• Auto Cook	103	• Electrical Operation	117
• Child Safety Lock	104	• Gas Operation	117
• Microwave Specifications	104	• Explanation of Operating Controls	118
		• Gas Operation	118
24. REFRIGERATORS	105	• Setting Temperature	118
• Winter Operation	105	• Door Locking	119
24a. Dometic RM Models	105	• Lighting	119
• Cleaning	105	• Storage Racks and Door Shelves	119
• Control elements of Energy		• Door Shelves	119
Selections	105	• Removable Freezer Compartment	120
• Electrical Operation	105	• Removing the Crisper	120
• Gas Operation	105	• Winter Operation	121
• Appliances with Battery Igniter	106	• Ice Cubes	122
• Door Locking	106	• Refrigerator Compartments	122
• Removable Freezer Compartment	107	• Shutting off the Refrigerator	122
		• Defrosting	122
		• Exchange of the Igniter's Battery	123
		• Troubleshooting	124

25. STAINLESS STEEL SINK	125	• Antenna Dome Coaxial Cable	135
26. SMOKE ALARM	125	34. GENERAL CARE AND MAINTENANCE OF YOUR CARAVAN	135
• Features	125	• Exterior	135
• Simple Maintenance	125	• Cleaning/Usage Information:	135
27. CARBON MONOXIDE ALARM	126	GENERAL CARE	135
• Features	126	• Acrylic Windows	136
• Testing	126	• Window Catches and Stays	136
• Testing the Sensor	126	• Humidity	136
• Maintaining/Testing Your Detector	127	• About Condensation	136
28. BATHROOM CARE	128	• How to Keep Your Caravan Dry and Avoid Condensation	137
• Bathroom Shower Tap	128	• High Temperatures	137
• Mirrors	128	• Furniture	137
29. THETFORD C262 TOILET	129	• Hinges and Catches	137
• Parts	129	35. CARAVAN KEYS	138
• Preparing for use (standard)	129	36. WINTERISATION & STORAGE	138
• Using The Toilet (Standard)	130	CARAVAN KEYS	138
• Emptying	130	37. MODIFICATIONS & DIY WORK	139
• Cleaning and Maintenance	130	38. SPARES & AFTERSALES	139
• Caravan Equipment	130	39. FRONT BED MAKE UP	140
• Toilet Bowl	130	40. RETRACTABLE BED ASSEMBLY	140
• Waste Holding Tank	130	41. SIDE DINETTE BUNK ASSEMBLY	141
• Winter Operation	131	42. SIDE DINETTE BUNK ASSEMBLY	142
30. ECOCAMEL SHOWER HEAD	131	43. USEFUL CONTACTS	143
31. SOFT FURNISHINGS	132		
• Carpet	132		
• Upholstery	132		
• Cleaning and Care	132		
• Winterisation and Storage	132		
• Curtains	132		
32. REMIS BLINDS	133		
REMIBASE PLUS WINDOW BLINDS.	133		
• Cleaning	133		
• Remi Flair	133		
• Function	133		
• Maintenance	133		
33. STATUS 550 ANTENNA	134		
• Travelling	134		
• Operating	134		
• DAB and FM Radio Operation	134		
• Dependent on location, DAB and FM reception may be improved by setting the antenna to vertical.	134		
• Fault Finding	134		
• Gain Control	134		
• LED Light	134		
• Short Hook Up-Test 1	134		
• Short Hook Up: Test 2	135		

©Bailey of Bristol 2014. All rights reserved

No part of this document may be reproduced or transmitted in any form or by any means, electronic or mechanical, for any purpose, without the express permission of Bailey of Bristol Ltd.

1. INTRODUCTION

Welcome!

Congratulations on the purchase of your Bailey caravan. We would like to welcome you into the ranks of Bailey owners. We are confident that this vehicle will give you many years of enjoyment.

This handbook has been designed to enable you to derive the maximum benefits and pleasure from your caravan. Its information and hints will be beneficial and help to protect your investment whether you are a new or experienced caravan owner.

Please be aware that certain sections are only applicable to some models.

Information leaflets and literature on safe operation of appliances and equipment fitted to your caravan are included in the Bailey information pack. Please read these carefully prior to use.

Failure to observe recommendations or precautions could result in incorrect operation of equipment which could in turn lead to subsequent risk to occupants.

Regular maintenance is necessary to ensure trouble-free service from your caravan. Your Bailey retailer is equipped to offer service facilities, repair work and any spare parts that you may require. Always consult your supplying retailer before additional equipment is fitted to ensure the location of appropriate structural support.

Retailers are not agents of Bailey and have absolutely no authority to bind Bailey by any express or implied undertaking or representation.

Happy Touring!



Note

To enable Bailey and our retailer partners to deal with your queries efficiently, always quote your caravan's vehicle identification number (VIN) which can be found on the offside chassis member and is etched onto all major windows.

It is the Bailey policy to constantly improve their vehicles, so while all illustrations and descriptive matter in this handbook are intended to give a general idea of the caravan and are correct at the time of going to press, changing market and supply situations may prevent us from maintaining the exact specification details of this handbook. Bailey therefore reserve the right to alter the specification at any time without prior notice. Bailey offer a variety of customer uses and while each vehicle is designed to feature the optimum storage, seating, sleeping and fluid capacities, it is the customer's responsibility to select the correct loads without exceeding the weight capabilities of your chosen towing vehicle. These weights can be found on the weight plate located outside your vehicle next to the exterior door and on the Approval Label inside the gas locker.

Safety

This handbook contains the information that you will require for your safe enjoyment of your caravan. All the information contained herein is important. However, to draw your attention to specific items we have prefixed them with the following symbols to indicate a warning, caution or note respectively.



WARNINGS are items that if ignored can cause the user(s) physical harm.



Cautions are items that if ignored can result in damage to the caravan.



Notes are reminders that should be heeded.



IMPORTANT SAFETY NOTES:

To ensure all the occupants of your caravan enjoy a safe and relaxed environment please observe the following.

- Ensure all the occupants are aware of their escape routes in the event of a fire.
- Always keep escape routes and exit points clear from obstruction and debris.
- Provide one dry powder fire extinguisher of an approved type or complying with ISO 7465 Bsi 5423 of at least 1kg (2.2lb) capacity by the main door, and a fire blanket next to the cooker. Familiarise yourself with your fire extinguisher and the

local fire precaution arrangements.

- Your tourer is a compact living environment, and appliances should be treated in the same way as those in the home to prevent any accidental burning or scalding-keep young children away from hot surfaces.
- Your tourer is supplied with a EN1645 approved caravan step. Always take care when entering or exiting your tourer, ensuring that the step is securely located and safe before use. Do not use a damaged or broken step.
- The torque setting of the caravan's wheel bolts should be checked after the first 30 miles after collection of the caravan from the retailer. Thereafter, wheel bolts should be checked before every journey. The torque settings and tightening sequence are detailed on page 21 of this handbook.
- Never attempt to lift the tow hitch with your hands when hitching the caravan to the tow vehicle or at any other time. Always raise or lower the tow hitch by winding the handle on the jockey wheel.
- Always ensure that the green button located on the leading edge of the coupling head is raised before towing.

Driving Licences

A driver passing a test after 1 January 1997 is restricted to a car/caravan combination not exceeding 3,500kg (maximum laden weight, and where the maximum loaded weight of the caravan does not exceed the unladen weight of the car. New drivers outside these rules will need to take an additional driving test. Existing drivers who passed a test before 1 January 1997 are not affected.

2. STATEMENT OF CONFORMITY



All Bailey caravans have been certified by the National Caravan Council for compliance with UK and European standards and legislation along with industry codes of practice relating to health and safety issues. The approval process covers the testing and inspection of critical areas of the product from fire safety, weights and dimensions, to gas, electrics and ventilation. Every Bailey caravan carries the "NCC Approved Caravan" badge. The NCC conducts unannounced inspections at their members' factories to ensure continued compliance. NCC approval gives you peace of mind that your caravan is legal and safe.

Your Bailey caravan is European Whole Vehicle Type approved.

This assures you that your caravan meets all European regulations and has been constructed to conform to these rigorous standards for both manufacturing and product safety. This allows you to register your vehicle in another European country. Your certificate of conformity is in the document pack provided with your vehicle.

Inside your caravan is a certificate stating that the model is type approved. If for any reason you need another certificate your Bailey Caravan retailer is responsible for accessing one through the NCC system. Please refer back to your retailer for additional copies.

3. WARRANTY

If you have a problem or enquiry relating to your caravan please follow these steps:

Check the handbooks.

Contact your supplying retailer for assistance. The following suppliers provide a direct aftersales service. Please contact them directly:

AL-KO

AL-KO Kober Limited

South Warwickshire Business Park

Kineton Road

Southam

Warwickshire

CV47 0AL

Fax: 0044 (0)1926 818562

E-Mail: mail@al-ko.co.uk

DOMETIC

Dometic UK Ltd

Dometic House

The Brewery

Blandford St Mary

Dorset

DT11 9LS

Telephone: 0044(0)844 626 0130

E-mail: technical@dometic.co.uk

It is with the retailer that the purchaser's Contract of Sale exists and consequently Bailey Caravans cannot enter into any discussions with the purchaser.

All Bailey products are classified as "portable". All work under warranty requires that the caravan be delivered to and collected from the Bailey retailer.



While every effort is made within this handbook to accurately reflect and describe our home market caravans (those purchased and stored in the UK) our policy of continued improvements and change in market and supply conditions mean that we reserve the right to alter specification without further notice. Some materials used in the production of our caravans can result in variations to the figures quoted in respect of measurements and weights.

Touring Caravan Warranty Cover

Total customer satisfaction is top priority at Bailey and the quality ethos extends to the aftersales service and market-leading manufacturer's warranty package that comes with every new Bailey touring caravan. In this way we not only ensure long-term peace of mind but also enhance the re-sale value of your investment.

6 Year Bodyshell Integrity Guarantee

Bailey Alu-Tech caravans are covered by a six (6) year Bodyshell Integrity Guarantee from the initial date of purchase. This cover extends to any structural degradation to the bodyshell that arises as a result of water ingress through any permanently sealed seam or joint with the exception of exclusions stated in the terms and conditions.

The following item is covered for three (3) years from the date of first registration

- Colour fastness of caravan bodyshell panels.

Warranty Extension

An additional four (4) year extension to the standard Bodyshell Integrity warranty cover (making 10 years cover in total) is available as a cost option. Please ask your supplying Bailey retailer for more information.

3 Year Manufacturer's Warranty

For a period of twenty-four (24) months from the initial date of purchase Bailey of Bristol offer a comprehensive warranty on all parts and components as well as full coverage for any manufacturing faults forming part of the original specification of the vehicle, with the following specified exceptions:

The following items are covered for one (1) year from the date of first registration:

- Microwave ovens
- Pioneer stereo radio/CD/MP3 players & speakers

The manufacturer's warranty then extends to an additional twelve (12) months on the following items:

- Chassis: all chassis members including corner steadies
- Suspension: axle suspension and braking system (excluding any damage to or faults

in brake drums and shoes that are caused through misuse of the braking system or from normal wear and tear)

- Running gear: road wheels (excluding tyres)
- Towing mechanism: all mechanical components fitted to vehicle (excluding electronics).
- Cooker: the cooker unit including burners, grill, oven, flame failure device and igniter
- Refrigerator: door seal condenser, gas control valve, gas igniter, flame failure device, 12 and 230v heater elements, gas thermostat, 230v thermostat and 230v temperature control switch
- Water system: water heater (gas or electric), fresh water tank, water pump, water
- Gauges, taps and shower head
- Electrical system: mains hook-up input connector, ELCB (Earth leakage Circuit Breaker), battery charger and distributor unit and interior lighting units (excluding bulbs)
- Cassette toilet: the cassette toilet is covered (excluding seals, valves and glands)
- Heating system: thermostat, motor, switches, control unit, gas heater, flame failure device (FFD) and igniter (excluding ducting and fittings)
- Windows: the functionality of the opening and closing system (stays, handles and catches) and a warranty against the cracking of the acrylic.
- Upholstery: zips, seams and colour fastness

Warranty Extension

An additional three (3) year extension to the standard Manufacturer's Warranty cover for mechanical and electrical components of a leisure vehicle both external and internal (making 6 years cover in total) is available as a cost option. Please ask your supplying Bailey retailer for more information.

Customer Support

In the unusual event of something going wrong your first contact should always be your supplying retailer. Approved Bailey Retailers enjoy industry-leading aftersales support service from the manufacturer and they should be able to offer all the help you need to rectify any problems that may exist.

Terms and Conditions

The Bailey Warranty Cover set out above is

offered subject to the following simple terms and conditions:

Cover

1. During the term of the Warranty Cover, subject to these terms and conditions, Bailey will, through an Authorised Service Centre, at its option repair or replace all parts and components of the caravan that are included in the Warranty Cover and which suffer a defect in manufacture or workmanship. An Authorised Service Centre means either Bailey itself, a Bailey approved retailer or a Bailey approved service centre. Any part which is replaced becomes the property of Bailey. Any replacement parts are covered for the unexpired term of the warranty cover.

Term

2. The initial duration of the Bodyshell Integrity Guarantee is six (6) years and the duration of the Manufacturer's Warranty is three (3) years, in both cases starting from the original purchase date of the vehicle. It is a condition of the warranty that an annual service is performed on the vehicle in accordance with the service plan. Failure to comply with this term will invalidate the warranty.

3. The unexpired term of the Warranty Cover on your vehicle may only be assigned, transferred or novated to subsequent owners with Bailey's consent (not to be unreasonably withheld) and on payment to Bailey of a transfer fee of £35. Transfer can only be made within the first three (3) months of subsequent ownership and full documentary evidence that the vehicle has been serviced annually must be provided at the time of assignment in accordance with the terms and conditions detailed above.

Repairs

4. The caravan must undergo a full annual service and inspection, including a moisture survey, carried out, subject to paragraph 5 below, by an Authorised Service Centre. The final annual service in the warranty period must be carried out before the end of that warranty period, but all other annual services may be carried out within six (6) weeks either side of each anniversary of the original purchase date. The original VAT invoices must be retained as proof that these annual inspections have been carried out.

5. During the first three (3) years of the Warranty Cover, all annual inspections and

repairs must be carried out by either Bailey itself or an approved Bailey service centre or agent. Thereafter, due to the technical nature of an Alu-Tech constructed caravan, annual inspections and repairs may be carried out by any workshop or repair centre approved by the National Caravan Council that has attended Alu-Tech training courses at the Bailey factory.

6. Where an annual inspection identifies that repairs to the vehicle are necessary, the caravan must be made available for repair within six (6) weeks of the date of inspection for the purpose of carrying out the repair work.

7. No repairs, including the fitting of any replacement unit, may be undertaken or commenced under the terms of the Warranty Cover unless prior written authorisation is obtained from Bailey via an authorised Bailey retailer or service centre. No liability will exist with regard to any warranty claims not authorised in this way.

8. Bailey reserve the right to examine the vehicle before any repairs commence or any replacement part is fitted.

Registration and Use

9. The Warranty Registration Form must have been sent to Bailey within six (6) weeks of the original purchase date. It is the responsibility of the Bailey retailer to forward this information to Bailey. This is part of the terms of trading that the Bailey retailer has with Bailey.

10. The caravan shall:

- Only be used for its ordinary and intended purpose and shall not be subjected to any treatment or conditions which could reasonably be foreseen to cause or result in damage to the vehicle or excessive wear and tear
- Only be towed by a private car or private 4x4 vehicle
- Not be put out to hire, reward or any other commercial use, nor used in any race, competitions or rallies whether timed, official or otherwise.

Exclusions and Liability

11. Bailey's liability under this warranty shall be limited to supplying the reasonable costs of labour and materials required for the repair or replacement of faulty parts or components. Bailey shall be entitled to charge for any repair work which is necessitated by virtue of any loss or damage caused by your negligence

or default or incurred as a result of any modifications you have made to the vehicle. This warranty does not cover repair costs other than labour and materials.

12. The Warranty Cover does not include:

- Repair or replacement of parts, components, seams or panels which are not part of the original construction of the caravan, or which have been tampered with or undergone unauthorised modifications, or which have been repaired otherwise than by an Authorised Service Centre
- Parts or components other than those specifically listed in the Bodyshell Integrity Guarantee and Manufacturer's Warranty descriptions set out above
- General maintenance or components failing due to fair wear and tear or normal deterioration repairs necessitated by lack of routine or regular maintenance. Particular attention is drawn to the Owner's Manual and Service Handbook supplied with the caravan and any maintenance instructions or notices published from time to time by Bailey relating to the proper care and maintenance of vehicles
- Structural degradation or other damage caused by water ingress through non-permanently sealed seams or joints (such as, without limitation, around windows, hatches, doors and rooflights), beyond the initial 24 months of the Manufacturer's Warranty.

13. No liability will be accepted for:

- Damage caused by neglect or abuse, corrosion, intrusion of foreign or deleterious substances, lack of servicing, over-heating, freezing, or the continued use of the vehicle after a fault has become evident
- Any loss or damage caused to parts not covered by this warranty cover, including soft furnishings or trim
- Any accidental or fire damage or any losses incurred by accident or fire
- Transport costs to and from point of repair.

Bailey will only be liable for costs which are incurred as a direct consequence of the event, defect or fault leading to the claim being made under this warranty. No liability will be accepted for any other loss or damage (such as loss of income or revenue, or loss of business or profits), costs, expenses or other claims for

compensation howsoever arising which was not reasonably foreseeable by both parties when the caravan was originally purchased. Bailey will not be liable for any loss or damage suffered by third parties, nor for bodily injury not caused by our negligence.

Nothing in this warranty shall limit in any way our liability: for death or personal injury caused by our negligence; for fraud or fraudulent misrepresentation; or for any matter for which it would be illegal for us to exclude, or attempt to exclude, our liability.

The purchaser has statutory rights in addition to this warranty and this warranty does not affect those statutory rights.

This warranty shall be governed by and construed in accordance with the laws of England and the parties irrevocably submit to the non-exclusive jurisdiction of the courts of England.

The name and address of the warranty and guarantee provider is:
Bailey Caravans Limited, South Liberty Lane,
Bristol, BS3 2SS

Warranty Registrations

The supplying retailer must explain the warranty terms and conditions to you, and complete the warranty registration process on-line. Your warranty will start on the day that the vehicle is first registered in the UK or 12 months from the date on which the vehicle was invoiced to the supplying retailer, whichever is the earlier.

4. CENTRAL REGISTRATION AND IDENTIFICATION SCHEME (C.R.i.S)

This caravan has been security marked and recorded under CRIS; this is the Central Registration and Identification Scheme that issues touring caravan registration documents, equivalent to the V5 registration document issues by the DVLA for cars. CRiS was established in 1992 by the National Caravan Council and provides a method of registering the "keeper" details of every tourer manufactured by NCC member companies to help prevent and detect caravan-related crime.

Why register with CRIS?

- Safety
- Security
- Warranty

Did you know?

- You should not take a tourer abroad without a registration document. If you go abroad your CRiS registration certificate provides the necessary proof, required by the police and other authorities, that you are its registered keeper.
- If you need to make a claim on your insurance, CRIS can help speed up claims by providing details of your tourer and its purchase date to relevant parties.
- CRIS can help your tourer's manufacturer contact you in the event that there is any kind of product recall or fault that could affect the safety of your caravan.

Shortly after purchasing your caravan you should receive your Touring Caravan Registration Document. It will be sent to you by post to your home address.

Your Touring Caravan Registration Document will include a 17-digit character VIN (Vehicle Identification Number), shown in the top right hand corner. This 17-digit character VIN will be die stamped into the caravan drawbar and chemically etched on up to a maximum of 10 eye level windows.

If you sell the caravan please follow the instructions on the Touring Caravan Registration Document.

If you do not receive a Touring Caravan Registration Document, lose it, or any of the

details recorded are incorrect, please contact:

CRIS Registrations:

For help, support and advice Contact CRIS:

NCC

CRIS Ltd,

PO Box 445,

Aldershot,

GU11 9SF.

Tel +44 (0) 203 282 1000

Opening Hours:

Monday to Friday 8am to 8pm

Saturday 9am to 5pm

Sunday 10am to 5pm

5. COUNTRY AND COASTAL CODE

Upon arrival at your destination you should be aware of the Country Code.

Code of Conduct - Camp sites

Check the Site regulations.

Arrivals

Report to reception immediately on arrival.

Vehicle Movement

Keep to roadways unless otherwise directed. Adhere to speed limits. Note that these are generally 10 mph while on site. (Remember that the stopping distance on grass is considerably greater than on tarmac.)

Only a person in possession of a current driving licence may drive on site.

Park as advised on your pitch. Where possible leave 6 metres (20ft) of free space around your vehicle.

Use of Site

Use the electrical mains hook-up in the correct manner and with caution.

Ensure that all fresh water taps/connections are turned off after use.

Have care and consideration when using all facilities (toilets and showers etc) and leave them clean and tidy. Young children should be escorted.

Cautions

To avoid possible damage to sewage purification works, only approved chemical fluids must be used. Under no circumstances may coal tar, phenol or caustic-based fluids be used. Disposable nappies and similar bulky items must not be put into the chemical closet emptying points but should be wrapped in a polythene bag and placed in the container provided. (Put all litter in containers marked for the purpose.)

Noise

Do not make excessive noise.

Children should be restrained from making excessive noise.

Flying kites and model aircraft and the use of items like catapults or air guns as well as ball games should not be permitted among, or close to, caravans.

Musical instruments, music players, radios

and televisions should not be used to the inconvenience of other people on site.

Open and close doors quietly.

Power generators must be adequately silenced and used with consideration and according to restricted site times.

Dogs and Pets

All dogs and other pets should be kept under control.

Unless permission has been granted, no animal should be let loose on the site and leads should not exceed 3 metres (10 ft).

No animal should be allowed in the shower/toilet block.

Do not let animals foul the site.

Fire Precautions

 Adhere to and make note of all fire precautions including the whereabouts of the fire points.

It is recommended that a 1kg (2.2lb) dry powder fire extinguisher is carried. It should comply with BS 5423 ISO 7465 and be marked BSI or FOC approved. It is important to check at regular intervals that the extinguisher is working as is required by types meeting BS 5423. Make sure that the use-by date is frequently checked.

Careful thought is necessary for the positioning of a fire extinguisher, which should be near to the door but not too close to the cooking equipment where sudden flames could make it unreachable. In the kitchen area, a fire blanket is a worthwhile precaution.

Unless permission has been granted barbecues should not be used. When permission has been given, consideration should be given to the annoyance that can be caused to other users of the site. Open fires are not allowed.

Awnings and Tents

Awnings and tents should only be used when permission has been granted.

When on grass and staying for more than a few days, the ground sheet and/or side flaps of awnings should be periodically raised in order to avoid damage to the ground.

Departure:

Leave the pitch clean and tidy.

On leaving check out with reception, paying the required dues.

On no account should:

- Litter be disposed of other than in the receptacles provided.
- Water be allowed to escape from the vehicle.
- Chemical toilets be emptied except into the disposal places agreed with the landowner.
- Washing or similar to be hung outside of the vehicle.

Handbook

Before using the caravan, all aspects of the handbooks should be read and adhered to.

Environment

Care and consideration should be taken to protect the environment.

Observe the Country and Coastal Codes shown below.

The Country Code

Enjoy the countryside but respect its life and work.

More people than ever before are exploring the countryside, interested in farming, plant life, bird watching or just observing the general wildlife. Whatever your interest, there is a lot to learn, but please observe the following code.

Guard against all risk of fires. Hay and heath land catch alight easily and once ablaze are very hard to put out. Remember fire spreads quickly.

Keep to the public paths across farmland.

Use gates and stiles to cross fences, hedges and walls.

Leave livestock, crops and machinery alone. View from a distance.

Take your litter home; it is unsightly and harmful to wildlife.

Help to keep all water clean.

Take special care on country roads

Make no unnecessary noise. Most Animals are timid; noises can disturb them unnecessarily. If you want to get the best out of the countryside, travel around as quietly as possible.

The Coastal Code

As our coastlines are increasingly used for recreation and education, the following suggestions are made to enable us to enjoy our inheritance and preserve it for posterity.

Do not trample about, or move rocks unnecessarily.

Do not frighten seals or sea birds.

Do not spear fish.

Do not spill detergents, solvents or fuel from boats as these can kill marine life.

When using a boat, moderate your speed, the wash from a fast boat can destroy both banks and nests.

Live molluscs and crustaceans need not be collected as souvenirs, dead shells can usually be found.

Shellfish can take years to grow and fines can be imposed for not observing national regulations.

Do not pull up seaweed unnecessarily.

Make your visit instructive, not destructive.

Look at material, don't remove it. Take notes and photographs, not specimens.

Observe bye-laws and be considerate to others.

National Trust property or Country Parks have regulations to protect the wildlife. Follow these.

Roof Loading

 Do not allow children to climb on the roof of your caravan.

Take special care when on the roof particularly in wet or frosty weather conditions, as the surface could be slippery. Always wear practical footwear when climbing onto your vehicle.

Safety and Security

 Your attention is drawn to the notice fixed in your Caravan advising on fire protection, ventilation and what to do in case of fire.

Children

Never leave children alone in the caravan and keep potentially dangerous items out of reach as at home, e.g. matches, drugs etc.



When upper bunks are used by children, especially those under the age of six (6), care should be taken to ensure against the risk of them falling out. These bunks are not suitable for the use of infants without adult supervision.

Fire Extinguishers

It is recommended that a 1kg (2.2lb) minimum capacity dry powder fire extinguisher be located near to the main habitation entrance door.

A pan fire should not have a fire extinguisher aimed at it but be smothered with a fire blanket. This should be within easy reach of the hob but away from the source of flames.

In Case of Fire

- Get everyone out of the caravan as quickly as possible using whichever exit is quickest including windows.
- Raise the alarm - call the fire brigade (In the UK dial 999).
- Turn off the gas container valve if safe to do so.



Your caravan is fitted with a smoke alarm. The operation of the alarm should be tested after the vehicle has been in storage, before each trip and at least once per week during use.

Ventilation and Condensation



The ventilation points on your caravan are fixed points of ventilation which are specified by European standards. Under no circumstances must these be blocked or obstructed. It is advised that fixed ventilation points and any protective screens are checked and cleaned (if necessary) on a regular basis.

Fresh air circulation should be allowed below the caravan when appliances are in use and when flues terminate below the floor to allow free evacuation of the products of combustion. At least three sides of the under-floor space should be kept clear and unobstructed

including by snow. Do not make any additional openings in the floor.

Additional night time ventilation is obtained by releasing the window catches and placing them in the second groove on the frame catch.



Under no circumstances should the caravan ventilation be covered, blocked or tampered with in any way.

Petrol and Diesel Fumes

The fitting of a tail pipe deflector to your exhaust will reduce the possibility of fumes entering your caravan through the front fixed ventilation points. However, an extension fitted to an exhaust tail pipe will be illegal if it projects beyond the vehicle body or bumper.

Original Equipment Appliances

See sections devoted to individual appliances.



Replacement parts for any appliance shall conform to the appliance manufacturer's specification, and should be fitted by them or an authorised agent.

Portable Appliances



Never use portable cooking or heating equipment, other than electrical heaters that are not of the direct radiant type, as it is a fire and asphyxiation hazard.

Modifications



Never allow modification of electrical or LPG (liquefied petroleum gas) systems and appliances except by qualified persons.

6. CARAVAN AND TOW VEHICLE

Choosing the right car and caravan combination for safe and stable towing is both an art and a science. It may seem complicated to the newcomer, but a few minutes spent understanding the basic principles, common terms and definitions in use will be worthwhile in ensuring your enjoyment of the caravan.

Caravan and Towing Vehicle Terms

Maximum Technically Permissible Laden Mass (MTPLM);

As stated by the vehicle manufacturer. This mass takes into account specific operating conditions including factors such as the strength of materials, loading capacity of the tyres etc. It is the maximum that the caravan can weigh on the road.



Under no circumstances should the maximum technically permissible laden mass of the caravan be exceeded.

Mass in Running Order (MRO): Mass of the caravan equipped to the manufacturer's standard specification and certain items of essential habitation equipment.

User Payload: The difference between the maximum technically permissible laden mass and the mass in running order.

The user payload includes:

Personal Effects: Those items which a user can choose to carry in a caravan and certain items of habitation equipment which are not included in the MRO or Optional Equipment.



Personal effects will include the wheel lock, jack and television if NOT supplied as standard with the caravan.

Optional Equipment (OE): Items made available by the manufacturer over and above the standard specification for the caravan.

The masses relevant to your model of caravan can be found at the back of this book.



Please take care to ensure that you have allowed for the masses of all items you intend to carry in the

caravan. e.g. optional equipment, essential habitation equipment and personal effects such as clothing, food, sports equipment etc. The actual laden mass of the caravan as towed should thus not exceed the maximum technically permissible laden mass. The actual laden mass can be measured on a public weighbridge.

Please note: weighbridges, although regularly checked, can give varying (inaccurate) results.

Nose Weight: The weight of the part of the caravan that is supported by the rear of the towing vehicle. This is sometimes defined as the "static load at the coupling head". The maximum nose weight for a caravan will be limited by either the towing vehicle tow hitch limits or the maximum load to which the caravan hitch is specified.



The towing vehicle and towing hitch handbooks/manufacturers must be consulted for their specification prior to towing.



The maximum static nose weight for all Bailey caravans is 100kg. This should never be exceeded regardless of whether the towing vehicle's upper limit is greater.

It is recommended that the nose weight should be varied to find the optimum for towing dependent upon the actual laden weight of the caravan. Experience has shown that the nose weight should be approximately 7% of the actual laden weight (i.e. between 50 and 100kg).

Measurement of the nose weight

Nose weight may be measured using a proprietary brand of nose weight indicator. Such equipment is obtainable from your Bailey retailer.

Another simple method is to use bathroom scales and a suitable piece of strong timber as a platform to rest the tow hitch on. The timber can be placed vertically between the caravan tow hitch and the bathroom scales. The timber should be of such a length that when the caravan tow hitch is lowered onto it, using the jockey wheel, the caravan floor is horizontal. The weight can then be measured.

When taking the measurement the jockey wheel should be raised and the corner steadies lowered until they are just clear of the ground.

Kerb Weight: The weight of the towing vehicle as defined by the vehicle manufacturer.

This is normally:

- With a full tank of fuel
- With an adequate supply of other liquids incidental to the vehicle's propulsion
- Without any drivers or passengers
- Without any load except loose tools and equipment with which the vehicle is normally provided
- Without any towing bracket.

The caravan to towing vehicle weight ratio:

This can be determined by calculation and is equal to:

$$\frac{\text{Actual laden mass of caravan}}{\text{Kerb weight of towing vehicle}} = 100\%$$

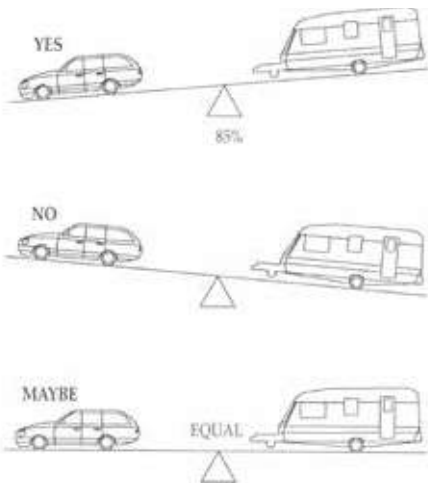

As a general guide:

- Conventional petrol engines with a capacity up to approximately 1600cc petrol or 1800cc diesel should be adequate for towing a caravan weighing around 85% of the kerb weight of the towing vehicle.
- Above 1600cc petrol or 1800cc diesel such engines should manage a caravan weighing up to 100% of the kerb weight of the towing vehicle and still give adequate performance.

The towing vehicle manufacturer's towing limit is, in some cases, less than the kerb weight.

Vehicles with automatic transmission may need an oil cooler fitted or the SAE (Society of Automotive Engineers) rating of the gearbox fluid increasing when towing. The advice of the vehicle manufacturer should be sought.

The law requires that caravans, their towing vehicles and the loads they carry must be in such a condition that no danger or nuisance is caused. (Regulation 100 of the Road Vehicles [Construction and Use] Regulations 1986.)

Towing Vehicle's Rear Suspension

It is important that the towing vehicle's rear suspension is not deflected excessively by the nose weight on the towball. If it is excessive the steering and stability will be affected and at night the headlight beam is likely to dazzle other drivers, which is illegal.

The greater the towing vehicle's tail overhang (the distance between the rear axle and the towball) the greater the effect the nose weight will have on the towing vehicle's rear suspension.

After trying out the caravan it may be found that stiffening of the rear suspension is necessary but note that this may give the towing vehicle a firmer ride when not towing.

There are a number of suspension aids available and advice should be sought on which to use and how to fit.

It is important to ensure that the caravan is towed either level or slightly nose down. If it is not, then the car's towbar may be at the wrong height.



Always consult your tow vehicle manufacturer for advice on towing and the loads that the vehicle is capable of towing.

Recommended Towball Height

The recommended towball height for Bailey caravans is 385 +/- 35mm (350mm to 420mm).

Secondary Braking Cable (breakaway device)

Purpose: To apply a trailer's brakes if it becomes separated from its towing vehicle.

Having done this, the cable assembly is designed to part, allowing the trailer to come to a halt away from the towing vehicle.

Construction; A thin steel cable, coated in red plastic and fitted with a means of attachment for connection to the towing vehicle.

Operation; In the event of the main coupling of the trailer separating from the towing vehicle, the cable should be able to pull tight, without any hindrance, engaging the trailer's brakes.



The breakaway cable should never become taut during normal use.

Correct procedure for use:

Regularly check the cable and clip for damage. If in doubt, contact your trailer or towbar supplier or your service agent.

Make sure the cable runs as straight as possible and goes through a cable guide underneath the trailer coupling.

Determine whether or not the towbar has a designated attachment point (i.e. a part specifically designated by its manufacturer for a breakaway cable).

Where a designated attachment point is provided on the towbar:

Pass the cable through the attachment point and clip it back on itself (fig.a).

Where no designated attachment point has been provided on the towbar:

Fixed ball: Loop the cable around the neck of the tow ball. If you fit the cable like this, use a single loop only. See Figs. b and c.

Detachable ball: You must seek guidance on procedure from the towbar manufacturer or supplier.

Other means of attachment:

In some instances it may be possible to attach the cable assembly:

Either:

To a permanent part of the towbar structure, as long as this meets the approval of the towbar manufacturer/supplier,

Or:

To an accessory sold for the specific purpose of breakaway cable attachment.

When the breakaway cable is attached, check to ensure:

- a. That the cable cannot snag in use on the Caravan coupling head, jockey wheel, or any accessory, e.g. a stabiliser, bump shield, cycle carrier, etc.
- b. That there is sufficient slack in the cable to allow the towing vehicle and caravan to articulate fully without the cable ever becoming taut and applying the brakes. For peace of mind you might wish to check the state of the cable by positioning the caravan and towing vehicle at extreme angles before setting off.
- c. That it is not so slack that it can drag on the ground. If left loose, the cable may scrape along the ground and be weakened so that it subsequently fails to do its job. The cable may also be caught on an obstacle when in motion, thus engaging the caravan's brakes prematurely.

Having followed this advice, should you feel that a satisfactory coupling arrangement cannot be achieved, consult your trailer or towbar supplier or service agent.



It is a legal requirement that the secondary breakaway cable is used when towing.

Loading and Distribution of Weight in the Caravan and Car.

Equipment and personal effects should be loaded in the caravan so that any heavy items are low down near the floor and mainly over the axles.

The remainder should be distributed to give a suitable nose weight at the towing coupling.

It should be noted that with certain layouts or models it may be necessary to load heavy items, such as awnings, in the middle of the floor to achieve an acceptable and safe nose weight. It may not be possible to achieve the desired nose weight with all items stored out of sight in lockers and bed boxes (bunks).

Please take care that you have allowed for the weight of all items you intend to load into the caravan.

Nose weight

It is recommended that the nose weight should be varied to find the optimum for towing dependent upon the actual laden weight of the caravan. Experience has shown that the nose weight should be approximately 7% of the actual laden weight (i.e. between 50 and 100kg). However, this may be limited by the towing vehicle or caravan manufacturer's limit nose weight. Check with the car and caravan handbook, or consult your retailer. The upper limit for the caravan coupling head is 100kg.

Hitching Up

Before hitching up the vehicle always check the following:

1. All wheel bolts are tightened to the correct torque. For the alloy wheels fitted to the Unicorn range the bolts should be tightened to a torque 130Nm (Newton metres). For the steel spare wheel supplied with the caravan the wheel bolts should be tightened to 120Nm.

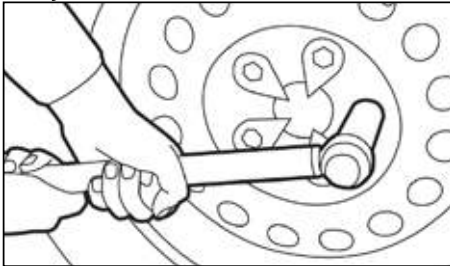

2. Inspect all wheels and tyres for signs of deterioration or damage.
3. Tyre pressures are correct according to the service handbook (remember to check the spare as well).

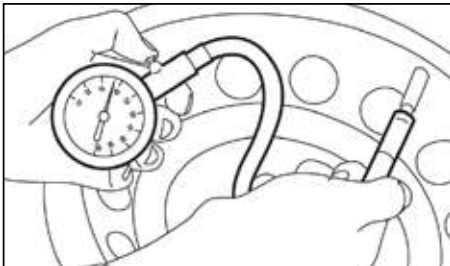

4. Ensure all loose articles are stowed securely.
 - Do not store heavy items in roof lockers. Televisions and other heavy items must always be secured at floor level when

towing.

5. All lockers and cupboard doors are closed and secured.
6. All bunks are secure.
7. All rooflights, extractor fans and sunroofs are closed and secured.
8. Tables are secured in their transit position.
9. Fridge is on 12V operation and the door lock is set (if required).
10. All windows are fully closed and latched. Never tow with windows on night setting.
11. Gas cylinders are correctly positioned, secured and turned off, the gas box is shut and locked.

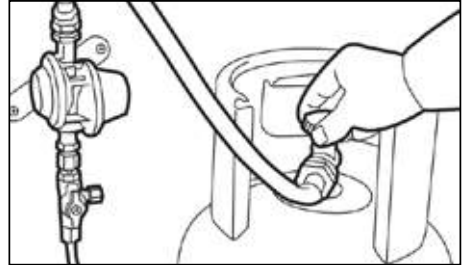

- Ensure no loose items are stored in the gas box and it is not overstuffing with equipment, as this may cause impact damage to the inside of the panel.

12. Battery strap is connected and the battery is secure.

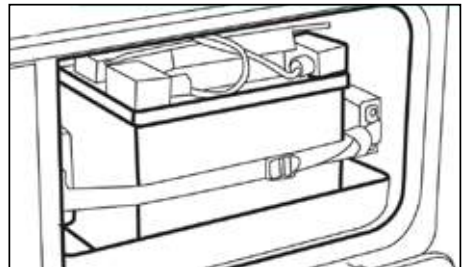

13. All external doors, flaps and ventilation ducts are closed and secure with their relevant covers in place.

- Before commencing any journey always ensure that the rooflights are closed and both handles are securely fastened.
- All gas appliances and the gas bottles must be turned off while towing
- It is recommended that a minimum of 2 people work together when hitching up the caravan to the tow vehicle.

Hitching the caravan to the tow vehicle

1. Ensure that the caravan is in a suitable position, and secure with the handbrake fully on.
2. Fully raise all four corner steadies.
3. Shut and lock the caravan exterior.
4. Gauge the height of the car's towball then raise or lower the height of the caravan's towing hitch to ensure that it is high enough to pass over it cleanly and not hit the tow ball. Rotating the caravan's jockey wheel handle can do this: Clockwise to lower, anti-clockwise to raise.
5. The assistant should position themselves by the front near side of the caravan so that they can extend an arm horizontally to indicate the position of the caravan's towing hitch.
6. Remove the car's tow ball cover and keep it in a secure place in the car.
7. Slowly reverse the towing vehicle towards the caravan. When reversing the towing vehicle towards the caravan always ensure that any pedestrians and your assistant are visible at all times.
8. When reversing aim the towball of the car directly at the caravan towing hitch.
9. When the car's towball is as near to the caravan's towing hitch as possible fully apply the car's handbrake, turn off the engine and leave the car in first gear (Park or 'P' position for automatics).
10. The final positioning should be carried out by manoeuvring by hand.
11. Carefully release the caravan's handbrake.
12. Manoeuvre the caravan's tow hitch directly over the towing vehicle's tow ball. Always manoeuvre the vehicle by pushing/pulling on the grab handles. When the caravan is in the correct position fully apply the handbrake.
13. Raise the handle on the caravan tow hitch until it clicks and remains at an angle.
14. Rotate the jockey wheel handle clockwise to lower the hitch onto the towball. When the tow hitch clicks and the handle drops to the horizontal position it is engaged. The hitch head is fitted with a visual indicator on the front radius to show whether or not it is properly connected to the tow ball. A green band will show immediately below the red indicator button on the hitch head when a proper connection has been made.
15. Connect secondary braking cable as per the instructions in the previous section.
16. Test that the hitch is now fully engaged by slightly raising the caravan hitch from the car towball by winding the jockey wheel handle anti-clockwise. The hitch should not release from the car towball. Only raise the rear of the car enough to check the hitch is fully engaged.
17. Turn the jockey wheel winding handle to lower the caravan. When the wheel is fully retracted, release the clamp and raise the jockey wheel to travel position.
18. Once the jockey wheel is in travel position and the wheel is located in the recess, tighten the clamp again.
19. All caravans are fitted with a single 13 pin lead. Where the connector for the car does not match that of the caravan an adaptor or replacement cable will be required. Please ask your supplying retailer for details.

Connect the lead to the receiving socket on the towing vehicle ensuring there is enough loose cable for cornering, but not too much so that it can drag on the ground.

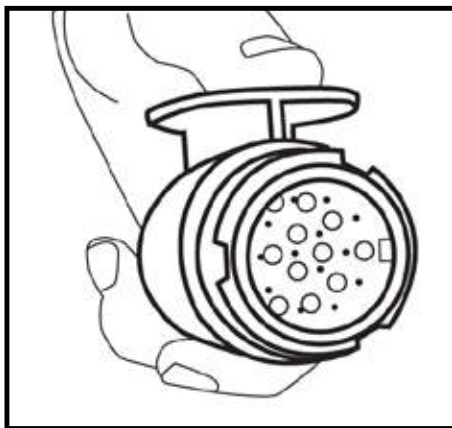

20. Check all towing vehicle and caravan road lights are working, and the operation of the brake lights.
21. Pick up any levelling pads or levelling boards.
22. Fully release the caravan handbrake.
23. Carry out a second check that the hitch is secure and the secondary braking cable is connected.
24. Adjust the car's driving mirrors from the driving seat to ensure good rearward visibility.

7. TOWING

Speed Limits

Where a lower limit is not in force, caravans may be towed at up to a maximum of 50 mph on single carriageways or 60 mph on dual carriageways and motorways.

Pulling Away

Allow more engine speed to produce the power to move the additional weight of the caravan. Let the clutch out smoothly. Avoid wear and tear on the clutch and transmission by taking extra care. Change gears smoothly. Try not to jerk the clutch.

Caravan Handling

Allow for the caravan being slightly wider than the car.

Allow additional distance from the kerb with caravan wheels so that they are not "bumped". When passing other vehicles allow more than normal clearance for driving solo.

Overtaking and stopping distances are increased when you are towing.

Always indicate in plenty of time before carrying out any manoeuvre.

Allow longer to accelerate up to speed prior to overtaking.

Allow for the vehicle being twice its normal length.

Do not suddenly swing out.

Carry out all manoeuvres as smoothly as possible.

Use nearside wing mirror to check caravan has cleared when overtaking.

Reversing

Proficiency at reversing can only be achieved with practice and should be first attempted in a large open area. Consider taking a suitable training course.

Motorway Driving

Caravans may not be towed in the outside lane of three or four lane Motorways (Reg 12(2) of the motorway Traffic [England and Wales] Regulations 1982).

Reduce speed in high winds, cross winds, downhill or in poor visibility.

High-sided vehicles such as lorries or coaches can cause air buffeting, so extra care must be taken when passing or being passed. Give

as much space as is possible between your caravan and the high-sided vehicle.

Mirrors

The law requires the driver of the towing vehicle to have an adequate view to the rear.

If there is no rear view through the caravan windows it may be necessary to have additional exterior towing mirrors fitted to provide a view along both sides of the caravan. In some countries these additional mirrors are a legal requirement.

Any rear view mirror must not project more than 200mm outside.

- The width of the caravan when being towed.
- The width of the towing vehicle when driven solo.

Any additional rear view mirror fitted shall be of an approved European type and cover the field of view as stipulated by the regulators.



Passengers are forbidden to ride in a caravan at any time.

Snaking

This is a term used to denote an unstable car and caravan combination where the caravan "weaves" from side to side often causing a similar swaying movement in the car itself. Possible causes are:

- Insufficient tyre pressure on either the caravan or the tow vehicle.
- Tow vehicle too light or weight distribution.
- Incorrect loading or weight distribution.
- Excessive speed especially downhill.
- Side winds.
- Overtaking.
- Being overtaken by a high-sided vehicle.
- Erratic driving.
- Mixing radial and cross ply tyres.
- Nose of the caravan is towing too high.
- Insufficient nose weight.

For best stability aim at an 85% ratio of weights.

Stabilisers

A stabiliser should never be used to try to improve a caravan/towing vehicle combination that has poor stability as instability may appear at high speed.

However, a good stabiliser can make an acceptable caravan/towing vehicle combination more comfortable and easier to handle.



Holes should not be drilled in either the coupling head or "A" Frame members without prior consultation with the chassis manufacturer.

If you do find your outfit snaking, try to keep the steering wheel in a central position as far as possible, slow down gently and avoid braking if possible.

Road Lighting

All caravans are fitted with a single 13 pin lead. Where the connector for the car does not match that of the caravan an adaptor or replacement cable will be required. Please ask your supplying retailer for more information.

13 PIN PLUG

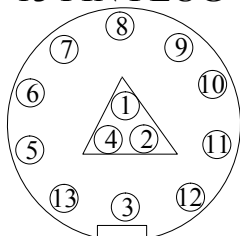

VIEWED FROM
THE REAR

KEY:

- 1 Left-hand direction, indicator light
2. Right fog light
3. Common return for Core Nos. 1, 2 and 4 to 8.
4. Right-hand direction indicator light
5. Right-hand rear position and marker lights, and rear registration, plate illumination device.
6. Stop lights
7. Left-hand rear position and marker lights and rear registration, plate illumination device
8. Reversing light
9. Continuous power supply
10. Power supply controlled by ignition switch
11. Return for core no 10
12. Coding for coupled trailer
13. Return for core no 9

8. ROAD LIGHTS

It is important that all the road lights on your Bailey caravan are checked before you set out on a journey.

All lights must be working in the correct manner for the vehicle to be road legal.

Clean the outside of the lights with a non-abrasive or non-aggressive cleaning solution.

Always replace a lamp which is showing any sign of damage.

EXTREMELY SUPERIOR!



Truma Dynamic Move[®]
TECHNOLOGY



NEW!



THE NEW TRUMA MOVER[®] XT

The new **Truma Mover XT** has been developed using years of experience and expertise by the leading manufacturer of Caravan Mover systems.

- Up to 20 kg weight saving over competitor systems
- Revolutionary design. XT is the first mover to use high efficiency brushless DC motors allowing the use of a smaller, lighter battery
- Brand new remote control, designed for intuitive and safe operation
- The finest control for stepless acceleration and security during moving, even on a slope
- Manoeuvre with ultimate precision on uneven ground and over obstacles with Truma dynamic mover technology

Experience for yourself the most advanced caravan manoeuvring system.

Available through **Truma Partner** dealers only.

For your local **Truma Partner** please visit the Truma UK website: www.trumauk.com



9. UNHITCHING

Do not pitch in a position in which your outfit will obstruct other people.

Try to choose an area that is dry, reasonably level and preferably with a hard base.

If you have no alternative but to pitch on a slope ensure that, for when you leave, you are facing down the slope.

It is good practice to chock the wheels of the caravan when parked on a slope even though the caravan brakes are applied.

Fully apply the caravan handbrake.

Un-clip and lower the jockey wheel to the ground.

Re-clip it in this position. Operate the button on the hitch head and move the handle forward to release the mechanism. Operate the jockey wheel handle until the coupling head is clear of the towing ball.



Serious damage will occur unless the button is depressed first and the handle lifted forward before the caravan is lifted manually. This prevents the nose weight being transmitted through the button.

Re-clip jockey wheel if necessary.

Disconnect the secondary braking cable.

Disconnect the 13 pin plug and return it to its holder.

Replace towball cover.

Park your vehicle alongside the caravan on the offside.

Levelling the Caravan

Levelling must be carried out in both directions in order for the refrigerator and other equipment to function correctly.



The positioning of the jockey wheel can be used to help level the caravan.

Lower the corner steadies until they are in firm contact with the ground.



Under no circumstances should the corner steadies be used as a jack as they are only a means of stabilising the caravan.

Levelling pads or boards should be used under the steadies where the ground is soft or uneven.

In extreme cases where it is necessary to raise a wheel off the ground for levelling purposes, further adequate support should be applied under the wheel so that the corner steadies do not take any undue strain.

Towing Brackets

All tow cars registered since 1 August 1998 must be fitted with a European type-approved towing bracket, by law. It is recommended that other cars not affected by this law use only towing brackets designed and tested to British Standard BS (AU) 114b, or ISO 3853.

10. WHEELS AND TYRES

Unicorn and Pegasus

Wheel, Tyre and Bolt safety fitment by Wheel Solutions Ltd.

WSL Individually Laser Balanced, TUV tested styled alloy wheels fitted with Michelin tyres and anti tamper WSL Safety Bolts.

Pursuit

Wheel, Tyre and Bolt safety fitment by Wheel Solutions Ltd

WSL Individually Laser Balanced, TUV tested styled alloy wheels fitted with Security tyres and anti-tamper WSL Safety Bolts.

Tyres

The tyres fitted to Bailey caravans are Michelin car and van tyres for the Unicorn and Pegasus range and Security Tyres for the Pursuit range. They are suitable for towing at sustained speeds of up to 81 mph (130 kph) to allow for use in countries which permit these speeds.

Radial and cross ply tyres should never be mixed. It is dangerous and can cause snaking. Fit only tyres that are of the identical specification on each side, unless towing for a limited time on the spare wheel while the tyre on the alloy is in repair.

Tyre Wear and Damage

The legal requirements for tread depth (1.6mm) on motor vehicles also applies to caravans.

In order to equalise wear it is suggested that wheels be balanced and changed around from time to time. When caravans are not in use for extended periods, wheels and tyres should be removed and stored in dry conditions and away from the outside elements. Alternatively caravans should be jacked up to relieve the load from the tyres.

It is dangerous to neglect tyre damage. Tyres should be checked for damage or cuts exposing the casing, or if a tyre has suffered an impact (for example against a kerb), it is advisable to have it examined by a tyre specialist as soon as possible.

The caravan industry recommends that, for safety reasons tyres more than 7 years old from the date of manufacture be replaced, but

preferably replaced at 4 years old. The tyres may have deteriorated by this time, regardless of tread depth.

The cleaning of tyres should only be carried out using soap and water. Petrol, diesel, paraffin and other solvents are not suitable.

If the caravan is not used for long periods of time (periods of longer than 1 month) it is recommended that the wheels/tyres are removed and stored upright in a rack, and rotated at least once a month to avoid the tyres becoming distorted. They can be covered with a natural material (e.g. hessian) for protection but NOT plastic materials. This will reduce the deterioration of the tyres and reduce the cracking and flat spots caused by continuous loading and external conditions.

If it is not practical to remove the wheels it is recommended to routinely rotate the wheels to reduce the potential of cracking, flat spots etc.



Check with your insurance company that you are still covered when the wheels are removed.

Tyre Pressures

Caravan tyres should be at the pressure recommended in the rear of this manual. The towing vehicle tyres should be set to the pressure recommended by the vehicle manufacturer for laden conditions. This will ensure the tyres and vehicle operate in a safe condition and maintain stability of the vehicle when towing.



Always check your caravan and tow vehicle tyre pressures when cold and prior to any journey. Also check tyre conditions for damage or cuts exposing the casing before and after any journey. (This includes the spare.) If in doubt it is advisable to have it examined by a tyre specialist as soon as possible. Incorrect tyre pressures can seriously affect towed vehicle performance and the longevity of the tyre.

Consult your tow vehicle manufacture for the correct tyre pressures for towing.

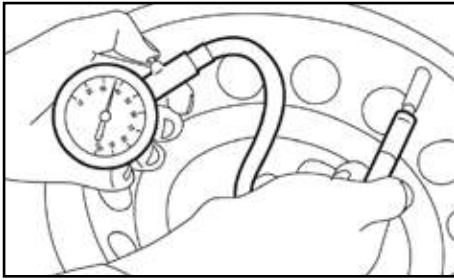

Wheels

Caravan wheel bolts must always only be tightened to the appropriate setting by tightening each opposite fixing in succession to the correct torque. Always use a calibrated torque wrench. Do not use a corner steady brace, power or electric wrench. It is as dangerous to over-tighten bolts as to not tighten them sufficiently.



The torque settings should be checked after the first 50km/30 miles. For alloy wheels the wheel bolts should be tightened to a torque of 130Nm (Newton metres) (96 lb-ft), for steel wheels the wheel bolts should be tightened to a torque of 120Nm (88 lb-ft)

The condition of wheels should be checked regularly, particularly for distortion of flanges and the wheel dish. Wheels damaged or distorted, or having the wheel bolt seating cracked or deformed, must not be repaired.

If a wheel or tyre has to be changed it should be of the same type of construction and size as originally fitted.



Only use a spare wheel and tyre recommended by Bailey Caravans, which should be of the same specification as those fitted to the caravan.

Always ensure mating surfaces and bolt seating areas are clean and dry. Wheel bolts should never be lubricated.

Spare wheels- optional extras with some models.

The spare wheel fitted to your caravan is an unbranded tyre.

1. Always ensure that the tow vehicle and

caravan are in a safe position before attempting to change the caravan's wheel. We recommend leaving the caravan hitched to the tow vehicle when changing the caravan's wheel. The tow vehicle should be left in gear (or "P"/Park for an automatic) with the handbrake on both the car and the caravan fully applied.

2. Lower the corner steadies as a safety measure to stabilise the caravan. Chock the un-punctured wheel on the opposite side of the caravan to prevent any movement.
3. Slacken off the wheel bolts by no more than one quarter of a turn on the wheel that requires changing. Do not fully undo them.
4. Place the jack plate under the axle tube as near as possible to the main longitudinal member. Where AL-KO Jack Brackets are fitted, only use either an AL-KO Side Lift or Scissor Jack.
5. Jack up the caravan until the wheel for removal is just off the ground.
6. Remove the wheel nuts and remove the wheel.
7. Fit the spare wheel, then reverse the above procedure. Ensure that the wheel bolts are all fitted, and tightened in the correct sequence to the right torque (see information under "wheels" for the correct sequence).
8. Remember to tighten all bolts to the correct torque and re-check after 50kms/30 miles.



Under no circumstances should the corner steadies be used as a jack: they are only a means of stabilising the caravan.

11. SPARE WHEEL CARRIER

Unicorn and Pegasus Models

The spare wheel carrier fitted in your leisure home is much like that fitted into your car.

To lower the spare wheel:

1. Remove the plastic stopper in the floor
2. The winder for the spare wheel carrier can be found in the kit bag supplied with the vehicle.
3. Remove the winder from the kit bag and insert the hooked end of the crank in the spare wheel retaining attachment.
4. Lower the spare wheel to the ground, with a little amount of slack. Pull the wheel out as far as possible before slackening the cable further. Repeat until the wheel is in the desired position.
5. Draw the spare wheel towards you from under the leisure vehicle.
6. Pivot the toggle at the end of the cable 90 degrees to release it from the spare wheel.

As a safety precaution have the flat tyre

replaced or repaired before fitting it back under the leisure vehicle.



When the spare wheel is being used on the vehicle, the retaining cable could damage the underside of the vehicle if not retracted.

Crank up the cable again by turning the crank clockwise. (The wheel with the flat tyre can be stored on the carrier for transport purposes.)

Returning the spare wheel to the storage compartment:

1. Use the crank (turn it counter clockwise) to lower the spare wheel's retaining cable. When there is no wheel attached, the cable will need to be gently pulled from the carrier during lowering to ensure the cable does not tangle inside the carrier.
2. Pass the toggle at the end of the cable through the centre hole in the spare wheel. Pivot the toggle 90 degrees so that when raised, the wheel will rest on the toggle.
3. Retract the retaining cable slightly by slowly turning the crank clockwise



**INNOVATIVE SAFETY SOLUTIONS
FOR YOUR PEACE OF MIND**



several times.

4. Position the wheel so that it is not obstructed by components under the floor.
5. Continue to raise the wheel by turning the crank clockwise. Raise the wheel a little bit at a time and guide it until it is securely seated against the floor.
6. When it is no longer possible to turn the crank any further check that the spare wheel is seated tight against the underside of the floor and has not fouled on any component.
7. Replace the plastic stopper inside the vehicle.

Retrofit of this carrier is available for Pursuit Models.

SPARE WHEEL RETAINER

Pursuit Plus Models.

The Pursuit spare wheel is located in one of the bunks or fixed beds and is retained in position with the use of a bolt into the caravans floor.

12. THE AL-KO CARAVAN CHASSIS (AKS 3004)

Chassis Members

The recommended tow vehicle coupling height is 385mm +/- 35mm from the ground to the centre of the ball.



Off road vehicles are exempt from this towball height specification.

Manufactured from high quality steel, the chassis has extra deep sections to provide strength at points of maximum stress. Large elongated holes are punched in the longitudinal and towbar, ("A" frame) members, to reduce weight to a minimum. Each hole incorporates a return flange to maintain the required strength and provide rigidity in the extra deep sections.

The chassis frame is of a bolted construction which, should the need arise, allows replacement of individual parts.

The chassis is Hot Dipped Galvanised. This is regarded as one of the best forms of corrosion protection. It does, however, require minimal maintenance in certain circumstances.

When new, the chassis is of a bright and shining appearance. As the galvanising cures during the initial 2- 3-month period, this will gradually change to a medium to dark grey colour. This grey finish is the ideal, giving the correct protective coating. During this curing period the surface should be protected to avoid possible wet storage stain, in the form of a soft, light coloured, porous, oxidation layer. If the chassis members are in contact with any salt deposits from roads this should immediately be washed off with a high pressure washer. Salt attracts moisture, allowing the surfaces to remain wet; this prevents curing and also allows formation of wet storage stain.



It is recommended that the chassis be washed off, using a pressure washer, on an annual basis (particularly after winter usage) to avoid undesirable build up of salt and dirt deposits.

The galvanised chassis should not be painted or subjected to any other protective treatment.

Should the galvanising become superficially damaged exposing the steel core, this should be cleaned and treated with a cold galvanising spray obtainable from vehicle accessory outlets.

Damage to chassis members through impact etc. must not be straightened or welded. Damaged chassis members must be replaced.



Drilling or Welding of Parts or Accessories

This chassis is designed and built to precise tolerances and must not be drilled or welded.

Independent Suspension

The AL-KO rubber suspension is designed and developed to suit all types of road conditions and is maintenance-free. Three rubber elements are contained within a hexagonal axle tube. These provide suspension and have inherent damping characteristics. (Only the hubs and wheel brakes require attention, see axle booklet Part No. 580458.)

Coupling Head

The ball couplings are entirely automatic in operation and designed for one-hand operation to suit the 50mm international ball recommended by the British Standards Institution, National Caravan Council and the Society of Motor Manufacturers and Traders.

Brake Drum/Hub Assembly

The Euro Axle fitted to your Bailey caravan comes complete with maintenance-free wheel bearings greased and serviced for life. Adjustment is not required during the design life of the sealed bearing (100,000 km).

- If replacement of the brake drum or shoes is required, this must be carried out by authorised AL-KO Service Centres. Specialist tools and equipment are required. The rear hexagonal bolt covered by a black plastic cover must NEVER be touched.

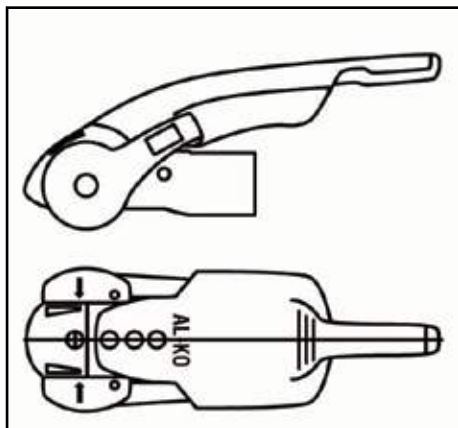

FIG. 1.

Operating Instructions

Coupling handle and stabilising lever.

The stabiliser lever (Fig.3/ Item 2) must be in the uppermost position (open).

Coupling

Pull the coupling handle (Fig. 2/Item 1) up in the direction of the arrow. The coupling mechanism has an open position, i.e. as long as the AKS 3004 is not placed on the ball, the handle will remain open. Put the opened coupling onto the clean towball. The handle must now make an audible click and return to the flat position.

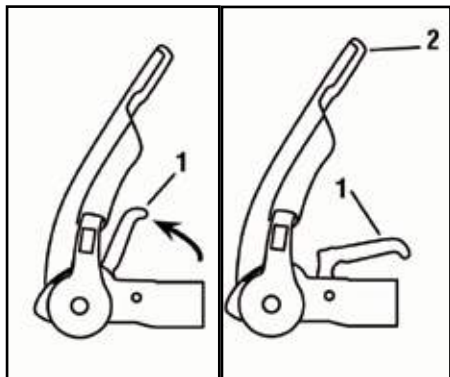

FIG. 2.

FIG. 3.



The coupling is correctly engaged when the green edge of the safety indicator button is visible (Fig. 4/ Item3).



Always ensure that the jockey wheel is fully raised and secure before commencing any journey.

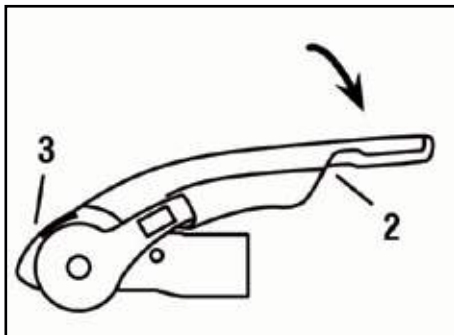

FIG. 4.

Stabiliser Unit

To operate the stabiliser (once coupled to the towball), simply press the stabiliser lever down as far as it will go (Fig. 4/Item 2).

Uncoupling

Pull the stabiliser lever handle up as far as it will go, lift the coupling handle and lift the AKS 3004 from the towball. With larger nose loads, coupling and uncoupling can be made easier by using the jockey wheel to assist lifting.

The friction pads are pressed against the towball and hence generate a stabilising/damping force. These pads are therefore subject to wear over time; however they will have a long service life (circa. 30,000 miles), provided they are well maintained and kept free of grease/dirt.

Uncoupling

Having lowered the jockey wheel to the ground, operate the handle as previously described. Lift the coupling clear of the towing ball either manually or by operating the telescopic jockey wheel.

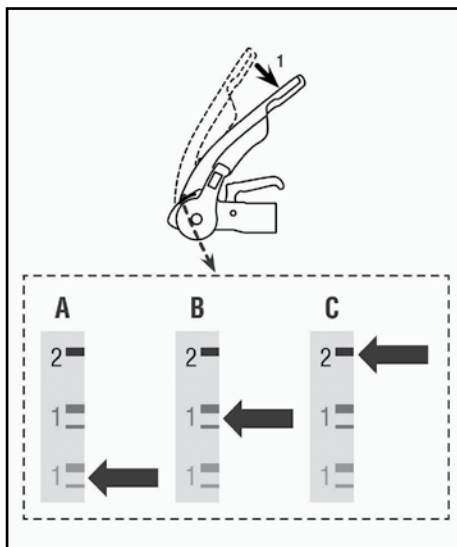

FIG. 5.

Checking the efficiency of the left/right friction pads:

1. Check that the stabiliser is correctly coupled by ensuring the coupling handle is fully down and the red indicator button is in the raised position.
2. Push the stabiliser lever (fig.5/item 1) down until resistance is felt (i.e. the friction pads are in contact with the ball but not yet under pressure).
3. Check the position of the arrowhead on the arm of the stabiliser. If it lines up with the two green lines then the friction pads are still as new (Fig.5/A)



If the arrowhead lines up with the two red lines then the friction pads are worn and should be replaced immediately.

When the stabiliser lever is correctly applied, the arrowhead should link up with the black line marked 2 (Fig 5/C).

The friction pads do not require any form of lubrication and should be cleaned with a fine emery paper prior to every journey. It is not necessary to adjust the friction pads.

Manoeuvring Operation

For easier manoeuvring (on camp sites etc), pull the stabiliser lever to the "up" position.

Please do not use the stabiliser lever as a manoeuvring handle. Please use the handles on the caravan or fit the AL-KO manoeuvring handle to your jockey wheel (available separately).

1. During opening or closing, the AKS must only be operated by one person.
2. Press the stabiliser lever down by hand force only DO NOT use your foot or an extension bar: this will damage the components (Fig. 6).
3. When opening or closing the stabiliser lever, please ensure your hand does not touch the coupling handle, you may accidentally trap your fingers! (Fig. 6.)

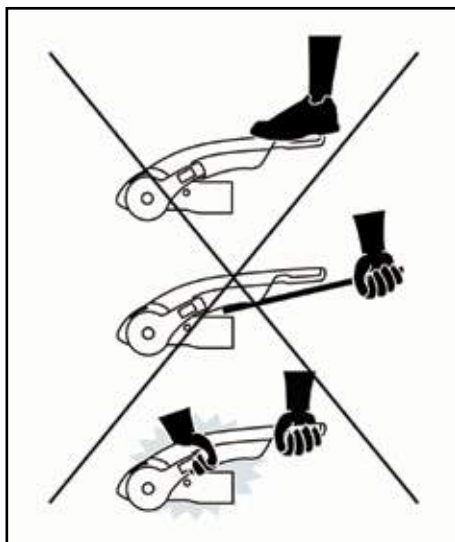

FIG. 6.

Noises while driving

As a rule, the friction pads of the AKS 3004 do not make a noise during driving. Any clicking, creaking or squeaking noises that do arise may be due to the following:

- a) Foreign bodies or dirt between the friction pad and towball.
- b) Dry operation of the draws-haft inside the overrun device.
- c) A detachable towball which has too much play in the locking mechanism.

Remedial Action

- a. Clean the towball and friction pads by lightly rubbing the surface (100-120 grit emery paper).

- b. Lubricate the draw-shaft sleeve via the grease nipples. In addition, push the gaiter forward and grease (DIN 51 825 KTA 3K) the exposed part of the shaft (Fig. 7).

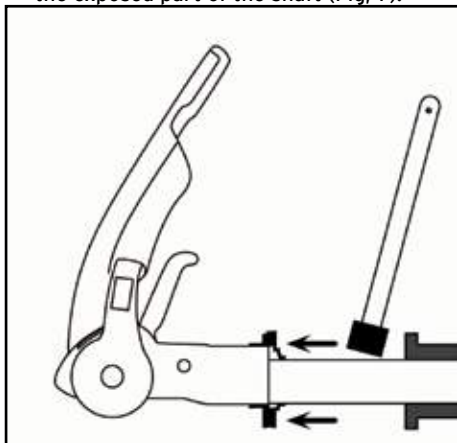

FIG. 7.

- c. Visit a specialist workshop to have the ball holding area checked for damage and the locking mechanism for function. If necessary, change the towball.

Storing

To reduce the possibility of contamination of component parts of the AKS 3004 the stabilising handle should be closed.

Towing Ball

The automobile towing ball should measure 50mm maximum and 49mm minimum diameter (DIN 74058). If the ball is below 49mm diameter it should be replaced immediately.

Overrunning Device

The device housing is packed with grease on assembly, but will require periodic maintenance to ensure smooth operation of the braking system.

- i. Re-grease the shaft bearings via the grease nipples provided at 3,000 mile intervals, and before storage.
- ii. Ensure correct functioning of all pivot pins and levers and oil regularly.
- iii. Ensure correct functioning of handbrake ratchet and oil regularly.

Jockey Wheel

Lubricate wheel and screw thread periodically with grease.

Brake Linkage

All moving parts should be lubricated periodically to ensure their satisfactory operation.

Corner Steadies

The screw and pivot pins should be lubricated periodically to ensure their satisfactory operation.

Braking System Adjustment

(At 500 miles, then every 3,000 miles or 1 year)

- i. Ensure the towing shaft with coupling heads is pulled fully forward.
- ii. Release the handbrake to the fully off position. If the handbrake will not go down the whole way because of the fairing or any other obstruction; then the fairing must be cut away and/or the obstruction removed to achieve this desired position. It will not be possible to set up the braking system properly when the handbrake is not in the fully off position (fig. 8).
- iii. Jack up one side of the caravan (see Jack Operation Instructions).
- iv. Remove the inner plastic bung from the backplate to expose the "star-wheel" adjuster access (FIG. 8).

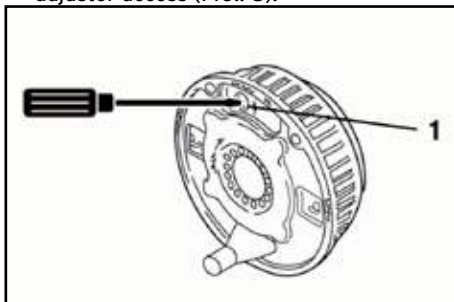

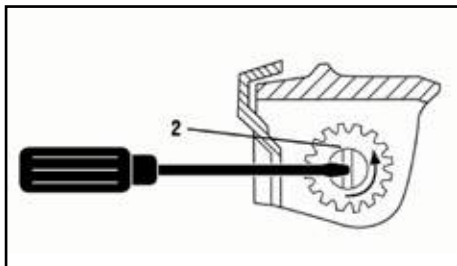

FIG 8.

- v. Always rotating the road wheel in the forward direction-never backwards, adjust the star-wheel with a suitable screwdriver, in the direction of the arrow embossed on the backplate until there is resistance in the wheel rotation (fig. 8).
- vi. Slacken off the star-wheel adjuster until the road wheel turns freely in the forward direction (fig. 8).
- vii. Check the adjustment at the end of the brake cable where it is secured to the abutment (bracket) welded to the centre of the axle. When the inner cable is pulled out it should extend between 5 and 8 mm. (On tandem axles a double abutment is fitted to the front axle only.)
- viii. Repeat for other wheel or wheels.

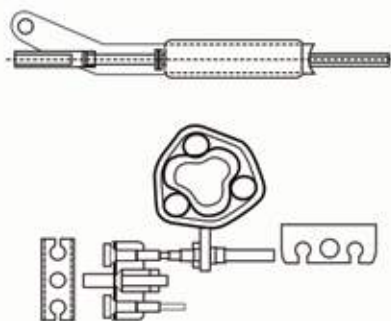

FIG 9.

- ix. Ensure the balance bar (compensation) is being pulled evenly. This bar (double on tandem axles) should always be paralleled with the axle tube when pulled (figs. 10). Adjust M8 lock and ball nuts, if necessary, to achieve correct parallel position (Fig. 9).
- x. Check the brake rod support bracket (fixed

to the floor) is supporting the brake rod evenly. The brake rod must always run straight, never bent or curved under any fittings. On tandem axles, using the double balance bar, a brake rod support tube (Part No. 228827) must always be fitted on the end of the brake rod, passing through the centre aperture on the abutment.

- xi. Remove the slack in the brake rod by adjusting the long ball nut, rear of the balance bar, ensuring the overrun lever makes contact with the end of the towing shaft. Over-adjustment to the long ball nut (Fig.10) could induce movement of the inner brake cable, reducing the effective clearance of the brake shoes. If the overrun lever will not make contact, it is possible the two lock nuts, forward of the spring cylinder, are incorrectly adjusted. Loosen the nuts and adjust the brake rod as above (Figs. 8 and 10).
- xii. Adjust the two locking nuts, forward of the spring cylinder (Fig. 9) (on some chassis a single Nyloc nut is used) (Fig. 10) to give 1mm of clearance on the spring cylinder. This cylinder (the energy store for the handbrake operation) must be able to rotate only, not slide on the brake rod. (See Fig. 9) If the overrun assembly is fitted with a gas strut handbrake then no spring cylinder is fitted, therefore ignore this paragraph.)
- xiii. Correct adjustment of the linkage is checked by operating the handbrake lever so that when the second or third tooth is engaged, a slight braking force is felt on the road wheels.
- xiv. Over-adjustment of either the wheel brakes or linkage will result in difficult reversing causing the wheels to "lock-up".
- xv. When parking, the handbrake lever must always be engaged into the fully upright position (90°). This is to compress the spring within the spring cylinder and thereby create an energy store, which will automatically engage the brakes further should the caravan move.
- xvi. If difficulty is experienced in this operation, try easing the caravan backwards with one hand while engaging the handbrake fully with the other. This manoeuvre should not be attempted on a rearwards facing slope. In this case wheel chocks should be used combined with the handbrake.

xvii. Finally, if the road wheels have been removed, re-tighten using a calibrated torque wrench to 130Nm (on all M12 wheel bolts - in sequence, i.e. North, South, East, West not clock or anticlockwise.) DO NOT over tighten this is just as dangerous as to under-tighten, as this can distort the wheel rims. Avoid the use of power wrenches.



The torque settings should be re-checked after 50km/30 miles. Wheel bolts should never be lubricated.



In order to operate the AL-KO braking system correctly adequate traction of caravan wheels is required when reversing. Therefore surface conditions that would result in a lack of traction should be avoided, for example: pea shingle/loose gravel.



Care should be taken when traversing ramps or other obstacles in order to prevent damage to the caravan under gear. When approaching such obstacles reduce towing speed appropriately.

Chassis Lubrication Points

1. Grease the drawbar in the area of the bellows.
 2. Grease the bearing bush through the grease nipples on the housing and the cartridge.
 3. Grease the pivot bolt of the overrun lever and handbrake levers through the grease nipple.
 4. Grease the joint of the brake rod and fitting.
 5. Oil the joints of the spring cylinder in the handbrake lever.
- Lubricant type: Multi-purpose grease to DIN 51825 KTA 3K4.

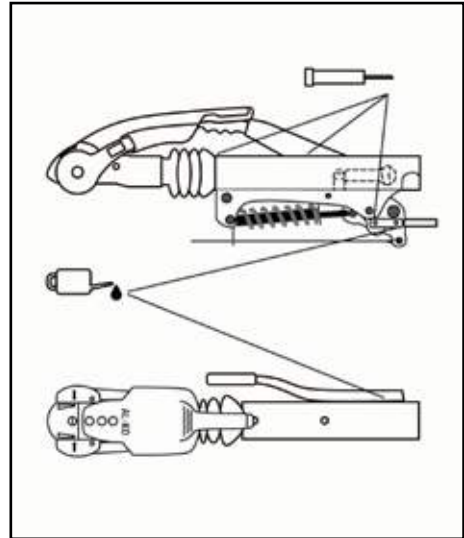

AL-KO ATC Trailer Control System

AL-KO ATC is an electronic, emergency control system for caravans and trailers. It automatically recognises critical swinging motions and applies the caravan brakes accordingly to regain control of the caravan and car.



Safety Information

AL-KO ATC is a passive safety product that activates the braking system on the caravan in unsafe driving conditions.

The driver has a responsibility under law to ensure that the elements of towing safety are met, including driving within the legal speed limit, consideration of road, weather and other traffic conditions, and correct loading and coupling of the caravan.

The electrical connection between the towing vehicle and the caravan must be in good working order.

Operating Instructions

After coupling the caravan correctly to the towing vehicle, connect the 13 pin plug to the towbar.

Upon connection, ATC will carry out an initial self test and the LED light on the front fairing will light up on RED. During the self test, the

sound of the push rod moving inside the ATC can be heard. When the self test is complete, the LED will turn GREEN or flashing GREEN to signal that the ATC is active.

If the LED does not change to GREEN, then the ATC is not functioning correctly.

Prior to commencing any journey, ensure that the caravan lighting is fully operational and check the vehicle is loaded appropriately, the nose weight and tyre pressures are correct, and confirm that the caravan is coupled to the vehicle with the breakaway cable correctly applied.

Always re-check that the ATC LED is green after any interval during a journey, such as a service station break.

Always disconnect your ATC once parked on a ferry, ensuring you reconnect before you restart the engine and leave the ferry. This will ensure that your battery is not run down during the crossing.

Should you experience any issues with your ATC please contact AL-KO or the supplying Bailey retailer.

Spare Parts

Spare parts are safety critical parts! For this reason when fitting spare parts in our products we recommend the use of original AL-KO parts or those parts that we have explicitly approved. The reliability, safety and suitability of parts designed especially for our products. Have been determined using a special test procedure. In spite of constantly monitoring the market we are unable to assess or vouch for other products.

If repair work or servicing is required AL-KO have a large network of AL-KO service centres throughout Europe. A list of service centres can be requested direct if required. Please bear in mind that repairs should only be carried out by trained and qualified workshops/personnel. To establish the correct spare parts the service centres need the ETI number = spare part identification number.

13. TRACKER RETRIEVE

The Tracker Retrieve is fitted to Unicorn Models only.

Battery Powered TRACKER Retrieve is a self contained device with its own power source, so the unit doesn't need to be wired into the vehicle's electrical system. This makes it more versatile in terms of both the range of vehicles into which it can be installed and the choice of location within the vehicle.

- TRACKER is operated by all of the UK's police forces
- Tracking equipment is fitted to police cars and air support units
- VHF technology gives you the best chance of getting your vehicle back, even if it is hidden in a container or garage.

What to Do in the Event of Theft?

1. The first thing you must do is call the Police to report the theft.
2. When reporting the theft, ensure you obtain the Crime Reference Number from the Police.
3. Once you have reported the theft, call the tracker 24-hour control room on:

0800 911 900

General Questions

Q. What is the life of my Battery Powered TRACKER Retrieve product?

A. The Battery Powered TRACKER Retrieve product has a 5- year life from the original installation date.

Q. What happens if my vehicle battery is disconnected?

A. Your Battery Powered TRACKER Retrieve product does not require any power from your vehicle's electrical system so is unaffected should the battery become disconnected.

Q. Can my Battery Powered TRACKER Retrieve unit be transferred from one vehicle to another?

A. No. For security reasons the TRACKER unit stays with the original vehicle for its lifetime.

Q. Will my TRACKER system work in Europe?

A. Battery Powered TRACKER Retrieve provides partial European coverage.

How TRACKER WORKS



1 Activate

Once you contact the police and confirm to TRACKER that your vehicle has been stolen TRACKER will activate your unit.



2 Track

Using our proven VHF technology, the police can begin to track your vehicle.



3 Locate

Using tracking computers in their cars and aircraft the police can locate your vehicle, even inside a container or lock-up.



4 Secure

Once located we will send a uniformed guard to wait with your vehicle anywhere in mainland Great Britain (terms and conditions apply).



5 Recover

Once secured, we will arrange for a recovery company to collect and return your vehicle to anywhere in mainland Great Britain (terms and conditions apply).





Market Leaders in innovative water and heating system technology



Innovation

Award winning, pioneering designs

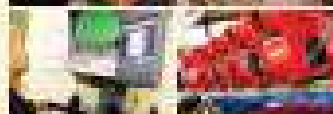
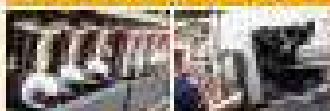

Quality

Every product, fully tested, every time

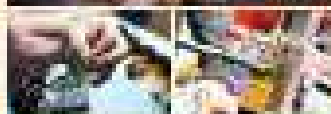
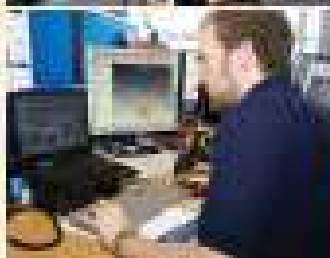

Service

First class support and advice

 Proud to manufacture in the UK

Our broad range of products includes innovative water and heating system products for the recreational vehicle market.



Water pumps

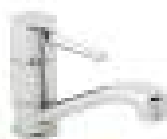

Taps and Showers



Space Heating



Water Heating



Plumbing



2 Enterprise Road, Bangor, Co. Down,
BT18 7TA, Northern Ireland.

Tel: +44 (0)28 91270631
info@whalepumps.com
www.whalepumps.com



14a. THE UNICORN III SINGLE AXLES AND PEGASUS GT65 WATER SYSTEM

Water Supply

These models are supplied with a 12v submersible pump, controlled by a pressure switch. The water inlet is located in the off-side exterior wall, protected by a lift up lid. This pump is designed to simplify the connection of an outside water supply to the caravan system.

The Whale Watermaster comprises a wall socket, plug complete with hose and submersible pump. The plug and socket combine both the water and electric connections. Designed for pumping fresh water into the caravan, the Whale Watermaster is also capable of supplying water to a water heater.

Operation

- Open one cold tap (e.g. the kitchen sink)
- Place the pump into a water container

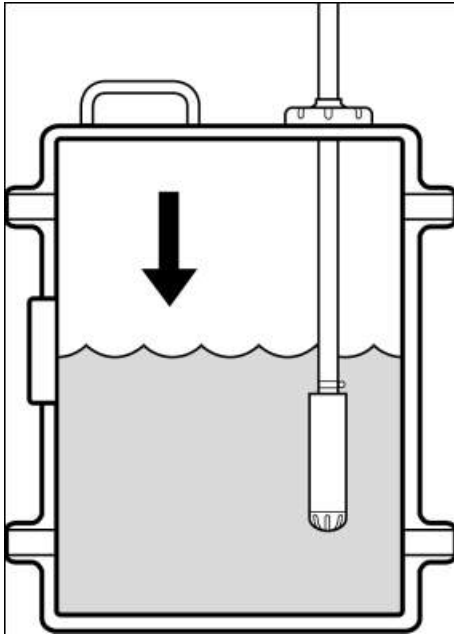

THE WATER SYSTEM

- Insert the plug into the wall socket and close the lid to lock plug in place.

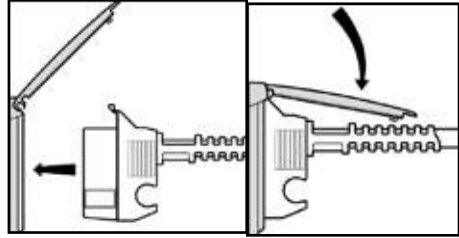

- Adjust the dust cover over the opening in container (please note: the dust cover should not be secured to water container as air must be allowed to enter the container to replace the water being pumped out)
- Switch on 12 volt supply at main panel (isolator switch)
- Water will flow from the open tap expelling any trapped air in a few seconds
- Turn off the tap; the system is now ready for use



The pump hose can be inserted into the groove on the plug to keep pump off the ground while refuelling the water container

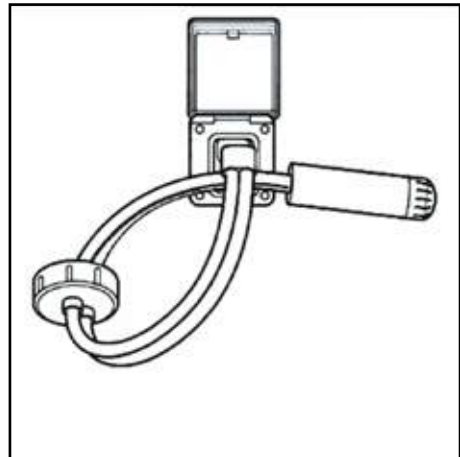

Removing the plug:

- Switch off the 12v supply at the control panel (isolator switch)
- Pull out plug from socket using hand grip
- Shut the lid.
- Do not run pump without water.
- Do not use the pump in water temperatures above 40°C (100°F)
- It is best to stand the pump vertically in the

tank.

- The micro-switch or phosphor bronze contacts can be removed for inspection or replacement.
- The pressure switch is sensitive to drops in battery voltage. As the voltage falls, should the unit need adjustment, turn anti-clockwise.

Routine Maintenance:

Ensure the hose adaptor O-ring and the socket in the housing are kept free from dirt.

Use only silicone or water-based lubricant on the inlet nipple O-rings on socket for lubrication.

Service the inlet socket annually (use Whale AK8834 service kit containing all serviceable parts).

Draining and Winterisation of the Water System

Bailey caravans may be in use all the year round, but when not in use, even for short periods, this procedure should be followed. One night in freezing temperatures is all that is required for expensive, permanent damage to the water system components.

Ensuring that all water is removed from the caravan's pipework, taps and appliances will reduce the risk of frost damage occurring. Frost damage can occur when water left in the system freezes and expands, causing the pipework and appliances to split, crack or burst.

- Ideally position the caravan so the drain valves are at the lowest point, e.g. tilt the caravan
- Switch off the 12v supply for all pumps at the main control panel (pump isolator switch)
- Open all taps/mixers in the mid position, including the external shower (if fitted)
- Remove the shower handset (including the external shower if fitted) and shake the water out
- Open the water heater drain valve and leave open
- Open the on-board tank drain valve (if present) and leave open
- Where grey waste tanks are fitted, remove all sink plugs and open the drain tap
- Open all other drain points (if present)
- External water components - shake water

out of pump/Aqua-source and store inside the caravan

- The shower tray cannot be expected to drain fully, some residual water may remain which will require "mopping up"

It is essential that the level of ceramic ball mixer taps is fully raised and in the central position. Failure to do this will not allow both the hot and cold water system to fully drain and will result in frost damage.



Frost damage cannot be claimed under warranty.

Setting up the water system

- Check all the plumbing connections
- Sterilise the water container and flush the system through with a sterilising fluid
- It is recommended that the water system is checked during the annual caravan service

Helpful hints

To obtain efficient running and maximum life, ensure the following:

- There is sufficient water in the container - do not run the pump dry
- All hose connections are firm and tight
- The power supply is adequate - low performance could result from a weak battery

14b. UNICORN III TWIN AXLE WATER SYSTEM

Water Supply

This model is supplied with an on-board 40L tank and inbuilt submersible pump as well as an external 12v submersible pump controlled by a pressure switch. The external pump can be used to supply water directly to the caravan from an outside water supply or it can be used to fill the on-board tank.

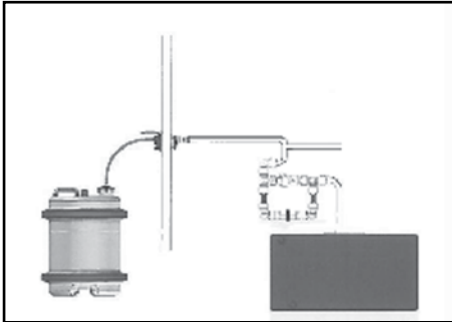

External supply

The water inlet is located in the off-side exterior wall, protected by a lift up lid. This pump is designed to simplify the connection of an outside water supply to the caravan system.

The Whale Watermaster comprises a wall socket, plug complete with hose and submersible pump. The plug and socket combine both the water and electric connections. Designed for pumping fresh water into the caravan, the Whale Watermaster is also capable of supplying water to a water heater.

Operation

- Open one cold tap (e.g. at the kitchen sink)
- Place the pump into a water container

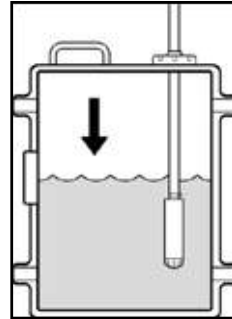

- Insert the plug into the wall socket and close the lid to lock the plug in place

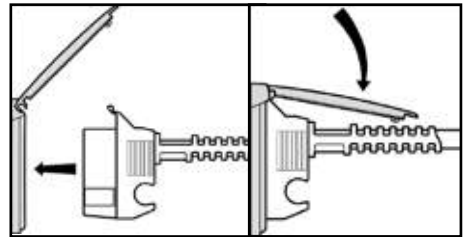

- Adjust the dust cover over the opening in the container (please note: the dust cover should not be secured to the water container as air must be allowed to enter the container to replace the water being pumped out)
- Switch on the 12v supply at the main control panel (pump isolator switch)
- Water will flow from the open tap expelling any trapped air in a few seconds
- Turn off the tap; the system is now ready for use



The pump hose can be inserted into the groove on the plug to keep the pump off the ground while re-filling the water container.

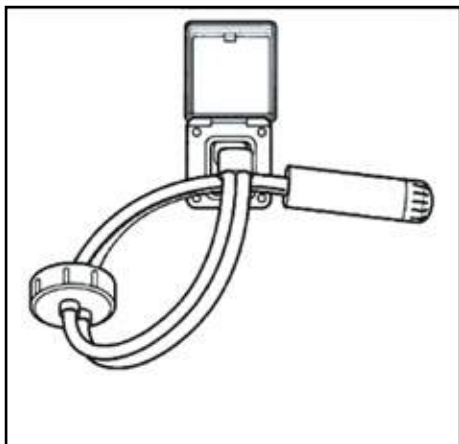

Removing the plug:

- Switch off the 12v supply at the main control panel (pump isolator switch)
- Pull the plug out of the socket using the hand grip
- Shut the lid
- Do not run the pump without water
- Do not use the pump in water temperatures above 40°C (100°F)
- It is best to stand the pump vertically in the tank.
- The micro-switch or phosphor bronze contacts in the socket can be removed for inspection or replacement
- The pressure switch is sensitive to drops in battery voltage. As the voltage falls, should the unit need adjustment, turn anti-clockwise

Filling the on-board tank

- Switch off the 12v supply for the on-board pump at the main control panel (pump isolator switch)
- Locate the 2-way valve in the heater compartment.

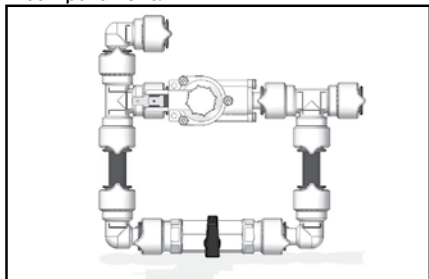

Turn the 2-way valve to the open position

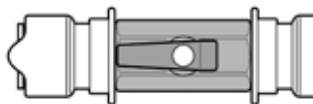

- Switch on the 12v supply for the external pump at the main control panel (pump isolator switch) and fill the on-board tank
- When the water runs from the overflow pipe below the caravan, switch off the 12v supply for the external pump at the main control panel
- Return the 2-way valve in the heater compartment to the closed position

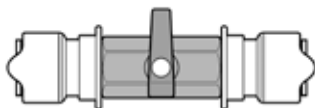

Internal supply

- Open one cold tap (e.g. at the kitchen sink)
- Locate the 2-way valve in the heater compartment

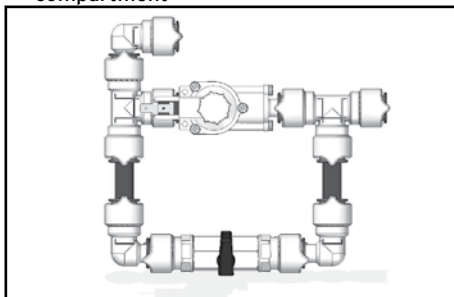

- Turn the 2-way valve to the closed position

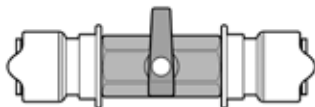

- Switch on the 12v supply for the on-board pump at the main control panel (pump isolator switch)
- Water will flow from the open tap expelling any trapped air in a few seconds
- Turn off the tap; the system is now ready for use
- Do not run the pump without water

- Do not use the pump in water temperatures above 40°C (100°F)
- It is best to stand the pump vertically in the tank.
- The micro-switch or phosphor bronze contacts in the socket can be removed for inspection or replacement
- The pressure switch is sensitive to drops in battery voltage. As the voltage falls, should the unit need adjustment, turn anti-clockwise

Tank Drain Operation

The tank must be drained prior to travel.

- Locate the 2-way valve attached to the side of the on-board tank

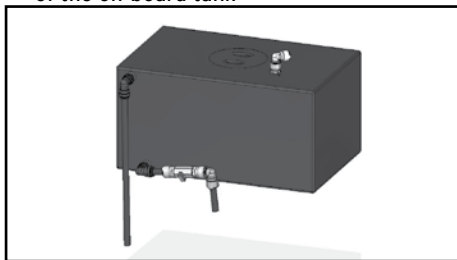

- Turn the 2-way valve to the open position

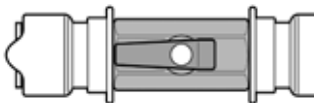

- The water will drain from the tank beneath the caravan
- Once all the water has been drained turn the 2-way valve to the closed position

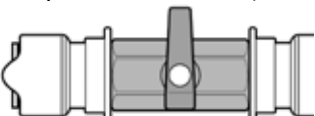

Routine Maintenance

Ensure the hose adaptor O-ring and the socket in the housing are kept free from dirt
Use only silicone or water-based lubricant to inlet nipple O-rings on socket for lubrication
Service the inlet socket annually (use Whale AK8834 service kit containing all serviceable parts)

Draining and Winterisation of the Water System

Bailey Caravans may be in use all the year

round, but when not in use, even for short periods, this procedure should be followed. One night in freezing temperatures is all that is required for expensive, permanent damage to the water system components.

Ensuring that all water is removed from the caravan's pipework, taps and appliances will reduce the risk of frost damage occurring. Frost damage can occur when water left in the system freezes and expands, causing the pipework and appliances to split, crack or burst.

- Ideally position the caravan so the drain valves are at the lowest point, e.g. tilt the caravan.
- Switch off the 12v supply for all pumps at the main control panel (pump isolator switch)
- Open all taps/mixers in the mid position, including the external shower (if fitted)
- Remove the shower handset (including the external shower if fitted) and shake the water out
- Open the water heater drain valve and leave open
- Open the on-board tank drain valve (if present) and leave open
- Where grey waste tanks are fitted, remove all sink plugs and open the drain tap
- Open all other drain points (if present)
- External water components - shake water out of pump/Aqua-source and store inside the caravan
- The shower tray cannot be expected to drain fully, some residual water may remain which will require "mopping up"

It is essential that the level of ceramic ball mixer taps is fully raised and in the central position. Failure to do this will not allow both the hot and cold water system to fully drain and will result in frost damage.



Frost damage cannot be claimed under warranty.

Setting up the water system

- Check all the plumbing connections
- Sterilise the water container and flush the system through with a sterilising fluid
- It is recommended that the water system is checked during the annual caravan service

Helpful hints

To obtain efficient running and maximum life, ensure the following:

- There is sufficient water in the container - do not run the pump dry
- All hose connections are firm and tight
- The power supply is adequate, low performance could result from a weak battery

Water System Troubleshooting

FAULT	CAUSE	POSSIBLE SOLUTIONS
Pump will not run	No power to pump	Check power supply Check the mains isolator switch is on Check the pump isolator switch is on
	Fuse has blown	Replace fuse (do not exceed recommended fuse size)
	Blockage in pipework	Check pipework for kinks Check pipework for blockage
Pump runs but no water appears	No water available	Check water tank is not empty Check filter cap is not blocked
	Water leaking from system	Check pipework and connections for leaks and repair as necessary Check water system drain plugs are closed
Pump runs but will not switch off	Water leaking from system	Check pipework and connections for leaks and repair as necessary Check water system drain plugs are closed
	No water available	Check water tank is not empty Check filter cap is not blocked
Pump cycles on and off periodically when all the taps are closed (normal with partially opened tap)	Water leaking from system	Check pipework/fittings for leaks and repair as necessary Check water system drain plugs are closed
	Pressure switch	Check pressure switch settings
	Power supply to pump	Check battery is not discharged
Low flow	Blockage in pipework	Check pipework for kinks Check pipework for blockages
	Power supply to the pump	Check battery is not discharged
	Pipework/connections crushed due to over tightened jubilee clips	Replace damaged connections
	Water leaking from system	Check pipework/fittings for leaks and repair as necessary Check water systems drain plugs are closed

Adjusting your Pressure Switch

Your pressure switch is factory set and should not normally require adjustment. However, adjustment may be required if the power supply voltage has varied from the previous setting, either due to battery drainage or higher voltage being supplied when the battery charger is operating. In the event that your pump doesn't switch off when you close the taps, or it pulses on and off rapidly when the taps are fully open, follow these guidelines to re-adjust the pressure switch setting.



Pressure Switch Setting

Ensure the system, including the heater is full of water and all taps are closed. Refer to your user manual.

Tighten the adjusting screw clockwise until the pump comes on. (For integral socket based pressure switches, first loosen the pressure switch locknut in an anti-clockwise direction.)

Open any tap until you have a smooth flow of water, then close the tap. You should hear the pump running and the pump running light if fitted will be on.

Return to the pressure switch and turn the pressure switch adjustment screw slowly anti-clockwise until the pump has stopped. Turn the screw a further half turn (180 degrees) anti-clockwise.

Check for correct operation by opening and closing all taps individually. The pump should turn on when the cold tap is opened and switch off immediately when the cold tap is closed. NB. There will normally be some pulsations at low flows.

The hot side may take about 10 seconds to react (both on and off) due to cushioning effect in the water heater.

For integral socket based pressure switches, carefully tighten the locknut until it is tight keeping the adjustment screw in position.

THREE GOLDEN RULES:

1. NEVER allow the pump to run dry
2. NEVER allow the pump to run continuously for more than 15 minutes
3. The pump assembly MUST be unplugged BEFORE putting the pump back into the refilled water container.

If setting of the pressure switch is still not correct you may experience:

Pump running continuously, even with tap closed. If undiscovered, could result in pump failure and flat battery. Most likely causes are that present voltage is significantly lower when last adjusted, or water container is empty.

CURE: Re-adjust switch or refill container

Pump does not run at all. If not due to blown fuse or faulty connections, then most likely cause is excessive continuous running (see above) **CURE:**

Replace pump and re-adjust switch

Pump runs intermittently ON, OFF, ON, OFF etc. Seen as pulsing flow from tap, or as inability to set constant water temperature, water goes hot, cold, hot, cold instead of constant warm. Most likely cause is that present voltage is significantly higher than when last adjusted.

CURE: Re-adjust pressure switch, if problem persists add a Whale Surge Damper (WS7205).

Pump runs very noisily but does not pump water. Likely to occur after water container has been refilled. Pump is air-locked and is fighting to get air out and water in.

CURE: Unplug from the socket, allowing pump to flood, and reconnect by plugging in again.

The correct sequence when refilling the container is to unplug, put pump into container, then reconnect.

Pump continues to run for up to 30 seconds after tap is turned off. This is not a problem. This is a characteristic of pressure switch systems caused by the dampening effect of the hot water heater or surge damper on the cold side.

If after following these procedures the system continues to pulse when all taps are closed there may be a leak in the system.
Please contact Whale Support for further guidance.

14c. THE PURSUIT WATER SYSTEM Truma Ultraflow Operating Instructions

Raise the lid, clean both the water socket and the plug of the pump assembly.

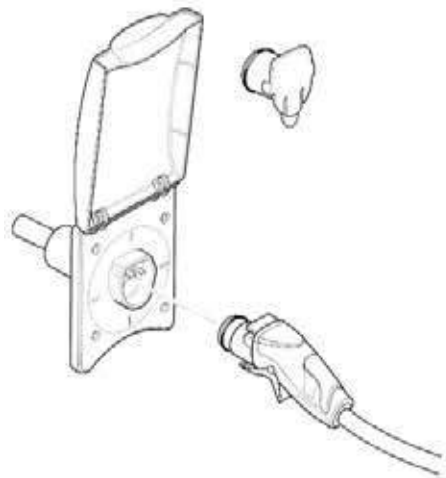

Plug the pump connector into the socket.

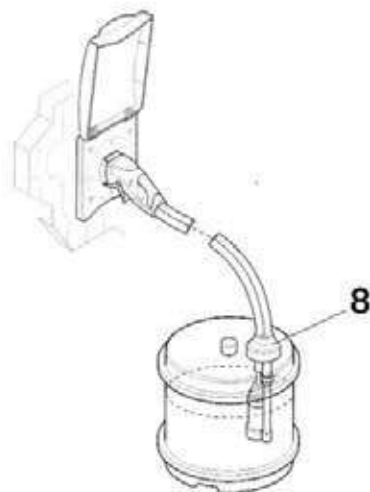

Place the pump into the water container, ensuring that it is fully submerged before operating the system. The dust cover (8) is to stop contaminants falling into the water container.

To remove the pump assembly from the Ultraflow Compact Housing, pull the trigger and pull out the hose plug.



Do not remove by pulling the hose or electrical cable.

Routine Maintenance

Ensure that the O-ring seals in the hose plug and the socket are free from dirt.

To aid fitting of the plug assembly smear the O-ring with vegetable oil.

Notes

Never allow the pump to run dry. Always ensure that the pump is submerged in the water or the life of the pump will be reduced.

Before winter storage the water system must be completely drained.

Clean the water system at the start and end of the season with sterilising fluid (see notes below).

If the pump fails to deliver water, the most likely cause will be air in the system. Switch off the pump and shake the pump assembly in the water. Then switch on the pump again.

Sterilising

When cleaning the water system at the start or end of the season it is advisable to use non-chlorine-based sterilising fluid.

Flush the system thoroughly to remove the effective fluid traces.

15. THE GAS SYSTEM

All gas appliances fitted to your Bailey caravan are suitable for operation on both butane and propane without the need for adjustment.

General information

Gas cylinders: Bottled liquefied petroleum gas (LPG) is the most convenient portable source of fuel for your caravan.

Cylinders are available in the following sizes:

Calor Gas = 3.9kg, 4.5kg, 6kg and 7kg.

BP Gaslight = 5kg and 10kg.

All sizes will fit into your gas box.



The gas system meets BS EN 1949:2011 and should only be modified by a competent person.

Never use portable cooking or heating appliances, other than electric heaters that are not direct radiant type, as they are a fire and asphyxiation hazard.

Types of gas

Butane

Butane is supplied in the UK in green or blue bottles.

Continental bottles usually have a male left hand thread similar to but not identical with UK Butane.

Butane is suitable for use at temperatures down to 2°C but will not work below that temperature.

Propane

Propane is supplied in red, or partly red bottles that have a female left hand threaded connector.

Scandinavian countries use the same connector.

Germany and Austria supply propane with a male connection.

Propane will work at temperatures as low as -40°C and is therefore suitable for all winter caravanning.

Make sure that heating, cooking appliances and gas cylinders are switched off before you move the caravan.

All gas appliances in your tourer can have their gas supply individually isolated by turning off the relevant tap. The tap is located either on the centrally positioned gas manifold or directly beside the appliance.

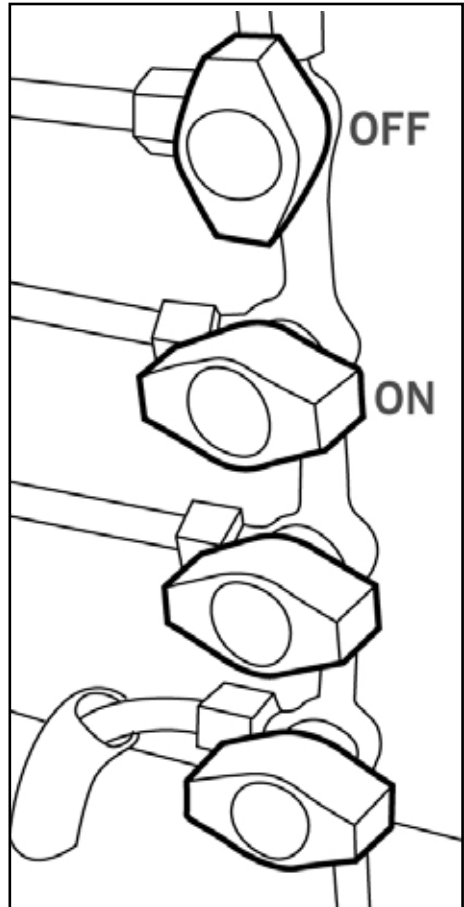

Regularly check flexible gas hoses, joints and connections for tightness.

Finally make sure that each gas appliance is working efficiently to the recommendations of the appliance manufacturers.

The Regulator

The regulator is a governing device which adapts the bottle pressure to one that suits the equipment in the caravan.

Your caravan is fitted with a regulator as standard equipment. This is located in the caravan gas box mounted on the bulkhead of the caravan between the gas bottles. The gas regulator has a working pressure of 30mbar and is suitable for both propane and butane liquefied petroleum gas. There are dedicated

hoses available for different types of gas/bottle. They are also available for camping gas and other mainland Europe LPG suppliers. Please contact your retailer who will have a stock of these hoses.



Some industrial LPG appliances operate at high pressure and require a "high pressure" regulator. This often has an adjusting handle on it. Never use such a regulator on a caravan.

- Propane and butane gas regulators are not interchangeable.
- Always ensure that the gas system is inspected/maintained every 12 months.
- In the event of a fire ensure all occupants evacuate the caravan via the nearest escape route.
- If it is safe to do so turn off the yellow isolation tap located in the gas box directly below the regulator.
- If you suspect a gas leak then immediately turn off the supply of gas at the yellow isolation tap located below the regulator in the gas box. Then turn off the gas valve on the gas bottles. When this has been completed the system must be inspected by a competent person.
- Never use gas bottles located outside the caravan gas box. Do not use any gas extension hoses.
- Gas barbecue, always use gas appliances that are suitable for use at 30mbar.

Your caravan is fitted with a regulator as standard equipment. This is located in the caravan gas box mounted on the bulkhead of the caravan between the gas bottles. The gas regulator has a working pressure of 30mbar and is suitable for both propane and butane liquefied petroleum gas. There are dedicated hoses available for different types of gas/bottle. They are also available for camping gas and other mainland Europe LPG Suppliers. Please contact your Retailer who will have a stock of these hoses.

Changing Gas Cylinder

Ensure that the cylinder is empty, then:

- Turn off the tap located by the gas regulator
- Turn off cylinder valve and all gas appliances
- Remove the gas hose regulator from the cylinder
- Release retaining strap

- Remove cylinder from gas locker and stand on ground
- Fit plastic protecting cap to cylinder

With the full cylinder:

- Before placing cylinder in the cradle ensure that the tray is clean and free from any debris. Cleaning should be carried out only with warm soapy water
- Place cylinder in cradle in gas locker
- Remove plastic protector from cylinder
- Connect the gas hose
- Connect retaining strap
- Turn on cylinder valve and then systematically relight appliances as required

Gas Safety Advice

LPG is poisonous.

There is a danger if all air and oxygen were excluded. (Ventilation holes must be kept clear at all times and must not be obstructed.) The manufacturers have given LPG a smell in order to identify leaks.

Gas Leaks

If a smell of gas becomes apparent, the supply should be turned off at the cylinder immediately.

Extinguish naked lights including cigarettes and pipes. Do not operate electrical switches. Open all doors and windows to disperse any gas escape.

Butane/propane gas is heavier than air; any escaping gas will therefore collect at a low level. The strong unpleasant smell of gas will enable the general area of the leak to be detected. Check that the gas is not escaping from an unlit appliance. Never check for leaks with a naked flame; leak investigation should be carried out using a leak detector spray.

Do not operate any electrical apparatus whatsoever, especially light switches.

If the leak is not obvious, the caravan should be evacuated and a competent service engineer consulted.

Avoid naked lights when connecting or changing a cylinder. Ensure the gas valve is turned off.

Regularly inspect the flexible gas hoses for deterioration and renew as necessary with approved type (all hoses should be replaced before the expiry date marked on the hose or after a maximum of five years).

Remember the gas is heavier than air and

therefore sinks to the lowest point.

Keep gas bottle containers outside (and protected against frost). If they must be kept inside make sure they are well away from heat.

Ventilation

All ventilation complies with EN 721 and vents should not be obstructed in any manner as this could lead to insufficient fresh air. In this case the confined atmosphere becomes depleted of oxygen which leads to the formation of the highly poisonous gas "carbon monoxide". Carbon monoxide is odourless, colourless and tasteless and will rapidly cause unconsciousness and death with little or no warning prior to collapse.



Under no circumstances should the caravan's ventilation be blocked or obstructed in any way.

High level ventilation is via the roof lights. The low level ventilation is via the vents in the floor at the front of the caravan living area directly behind the front bulkhead. With multi-berth layouts the rear sleeping compartments have their own low level ventilation. Please consult your caravan retailer for its location.

The mesh screens fitted should be kept free of obstructions by dust, leaves, insects etc. Inspect regularly and use a brush and soapy water as necessary. It may be necessary to remove the weather shield located on the underside of the floor of the caravan to gain access for cleaning.

All roof-mounted flue installations should be inspected once a year throughout their length for corrosion. Flues should be replaced if any sign of perforation is found. Ensure that the replacement is of an approved type. Check that the external roof seal is seating correctly and the locknut is fully tightened.



Do not make any additional openings in the floor.



Appliances such as cookers with naked flames should never be used for room heating.



No appliance shall be used inside when being connected to the external BBQ socket.

Gas BBQ point

The external gas BBQ point should be used as a connection outlet only and should not, as a matter of safety, be used as a gas inlet.

6. THE ELECTRICAL SYSTEM-230v

As in the home, care must be exercised when handling mains electricity.

Instructions for electricity supply - low voltage (230 v)

On arrival at caravan site



Before connecting the caravan installation to the mains supply:

- Check that the mains supply is suitable for your installation and appliances, e.g. whether it is AC or DC and whether it is at the correct voltage, frequency and polarity.
 - Check that your installations will be properly earthed. Never accept a supply from a socket outlet or plug having only two pins, or from a lighting outlet.
 - Check that any residual current device (RCD) or (earth leakage circuit breaker) in the mains supply to the caravan has been tested within the last month. After connection to site supply, test again.
- Make sure that the switch at the site supply point is off.
 - Make sure that the caravan RCD unit is switched off.
 - Remove any cover from the electricity inlet provided on the caravan, and insert the connector of the supply flexible cable.
 - Remove any cover from the socket outlet provided at the site supply point, and connect the plug at the other end of the supply flexible cable to this. Switch on the main switch at the site supply point.
 - Switch on the caravan RCD unit.

In case of doubt, consult the site owner or their agent.

On leaving caravan site

- First switch off the site supply.
- Switch off the caravan RCD unit.
- Then disconnect the pitch lead.
- Replace the cover of the socket outlet at the site supply point. It is dangerous to leave the supply socket or supply flexible cable live.

In case of difficulty consult an approved electrical installation contractor (which may

be the local electricity board). It is dangerous to attempt modifications and additions yourself.



Lamp-holder plugs (bayonet-cap adapters) should not in any circumstances be used.

Every 12 months, the caravan electrical installation should be inspected and tested and a report on its condition obtained as prescribed in the Regulations for Electrical Installations, published by the Institute of Electrical Engineers.

Generators

- Switch off all appliances, the miniature circuit breakers and the residual current device.
- Start the generator and allow to run for a few minutes to stabilise.
- Connect the caravan to the generator.
- Switch on 16 amp miniature circuit breaker.
- Switch on the residual current device.
- Switch on the fridge (230v phase) or plug in a 230v light to one of the 13 amp sockets.

This is to provide a load on the generator and help remove any "spikes" in the supply which can damage the charger unit.

- Switch on the 5 amp miniature circuit breaker and any other appliances you require.



It is always advisable to have at least one other mains appliance switched on with the charger unit to minimise the chance of damage to it.

Do not connect the 12v output of the generator to the battery terminals. The AC ripple must not exceed 10%.

Overseas Connections



Connection to a mains voltage supply overseas requires particular attention.

Care must be taken when connecting supplies abroad since the supplies can be of reverse polarity.

The significance of reverse polarity is that when equipment is switched off it may not be electrically isolated.

The only certain way of making equipment safe is to unplug it.

A means of checking the polarity of the mains supply when overseas is useful.

There are available several proprietary makes of equipment for the purpose (e.g. Martindale tester unit).

If it can be achieved, it is preferable to connect live to live, and neutral to neutral to maintain full electrical protection.

Check all caravan equipment is set up to accept the site supply before actually switching on.

Mains Unit

The mains unit replaces the conventional fuse box. Similar but larger units are often fitted in newer houses.

The unit gives overload and earth leakage protection for the 230v electrical supply in your caravan.

For normal operation all switches on the unit need to be in the ON position. The switches on the left of the unit are known as MCBs (miniature circuit breakers).

These take the place of the conventional fuse but are more convenient.

In the event of a fault the MCB trips e.g. automatically moves to the OFF position.

After elimination of the fault the M.C.B. can be re-set by switching to the ON position. (Against the spring pressure in an upwards direction.)

If an earth fault develops or a person was to touch a live piece of equipment the leakage of current to earth should immediately operate the RCD (residual current device) and "trip" the main switch, to the OFF position.

This switch is only re-settable after elimination of the fault.

To re-set, operate the switch as for MCBs
Every time you connect to a site supply the RCD should be checked by operating the test button marked "T". The unit should immediately switch to the OFF position. If the unit does not switch off then a qualified electrician should be consulted.

If the unit does switch off, the test is complete and the switch can be re-set restoring the supply back to normal.



Having too many appliances switched on at the same time will trip the MCB. This is a safety measure.



It is essential that connections are made exactly as shown. If terminal markings are not in accordance with the diagram they must be ignored. In doubt consult a qualified electrician.

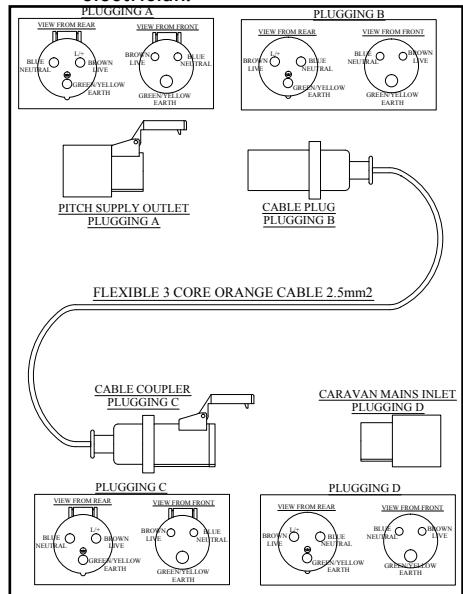

Always disconnect the electrical connector between the towing vehicle and the caravan before connecting a 230v supply to the caravan and before charging the caravan battery by any other means.

It is possible that all of the 230v mains electrical equipment may not be able to be operated simultaneously. A typical UK caravan park mains hook-up point provides a maximum output of 16 amps and on some continental sites the available output may be as low as 5 amps. If your loading exceeds the site supply it may trip the park's circuit breaker. Please check the available mains output with your site operator.

The following items need to be added together if used simultaneously.

230V Mains equipment typical consumption figures:

Fridge	0.5 amps
Colour TV	2.5 amps
Charger	1.0 amps
Microwave	10.0 amps
Air conditioning.....	4.0 amps
Blown/convection air heating	8.7 amps

17. THE ELECTRICAL SYSTEM- 12v

Your caravan is fitted with a 12v charger as standard. This converts the 230v AC supply into 12v DC. This enables the 12v equipment in the caravan to function and charges the caravan leisure battery. A fully charged caravan leisure battery should read 13.8 volts on the voltmeter mounted in the control panel.

The charger is capable of charging leisure batteries and will not overcharge.

The 12v system is designed to operate with a leisure battery in circuit and should not be turned on without one connected. The 12v supply to the caravan services can be isolated via the 12v on/off switch on the control panel.

Auxiliary Battery Storage/Mains Inlet

The battery and 230v mains inlet are located in a special locker mounted in the side of the caravan. The door frame has a cable recess allowing the door to be locked when the mains cable is connected.

This locker will accommodate a battery up to 110 amperes/hours capacity.



The battery must be placed in the tray provided in the battery storage compartment, and must be used at all times.

A battery of not less than 40-50 amperes/hours capacity is recommended. Crocodile clips should never be used to connect the battery, and terminals should be shrouded. Always switch off all appliances and lamps before disconnecting the auxiliary battery.

The battery should be secured to prevent movement when towing.

Metal objects should not be stored in the battery box.

Where a 12v extension is used between the tow-car and caravan, this should not exceed 5 metres in length- minimum cable size 2.5mm to minimise voltage drop.

DIY modifications/additions to the wiring systems are not recommended,. Always consult your retailer who will be pleased to carry out such work.

Do not continuously charge the battery when the caravan is not in use.



Switch off all appliances before disconnecting the battery.



Negative connections should always be disconnected first and reconnected last.



Car type battery chargers are not suitable for charging a leisure battery and may damage it.



When not using the caravan always ensure that the fridge control knob is turned to the "off" position. Failure to do this will result in a flat battery due to 12v power drain from the fridge circuit relays.

Battery Box Connections

The Pegasus GT65 range is fitted with a 12v external solar panel connection point. This can be found under the caravan mains inlet inside the battery box.

The Unicorn range also features a connection for a free standing external satellite dish. This connection is also located on the side of the vehicle along with the external 230v socket.

18. UNICORN III CONTROL PANELS

The control panels in the Unicorn III models consist of two separate switching blocks.

12v and Pump Controls (Single Axles)

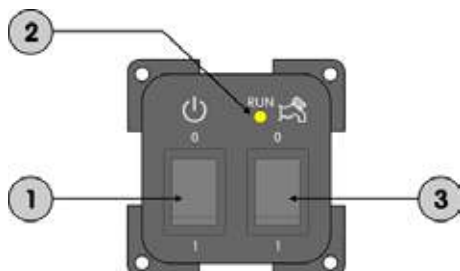

1. 12v main switch: 0 = OFF, 1 = ON.
2. LED "pump run": this LED is lit (yellow) when the pump is actually running.
3. 12V water pump switch: 0 = OFF, 1 = ON.

12v and Pump Controls (Twin Axles)

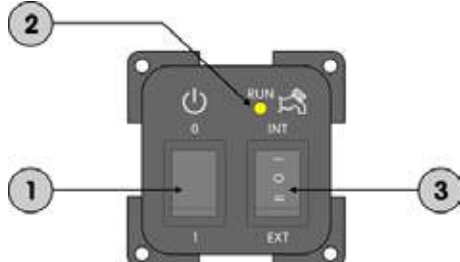

1. 12v main switch: 0 = OFF, 1 = ON
2. LED "pump run": this LED is lit (yellow) when the pump is actually running.
3. 12v water pump switch: 0 = OFF, INT= internal water pump ON; EXT= external water pump ON.

Battery Voltage.

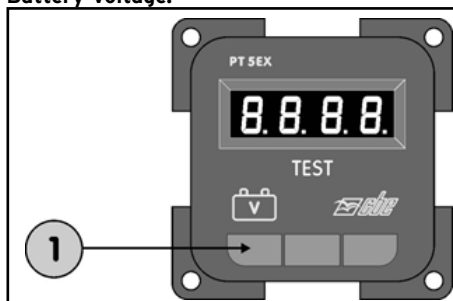

1. Button to check the voltage (in volts) of the connected 12v battery.

THE PEGASUS GT65 CONTROL PANEL

iVan Panel Operating Instructions

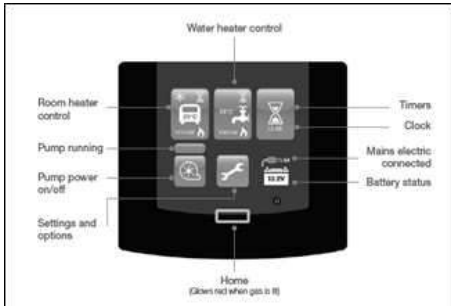

FIG. 1: Home Screen

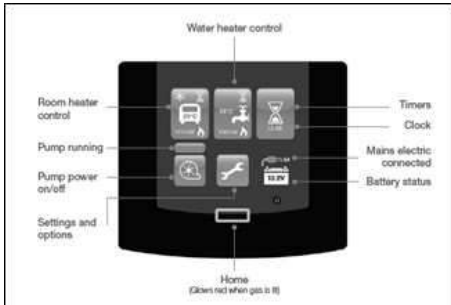

FIG. 2: Home Screen Functions

Operating the Space Heater

1. From the home screen, touch the “van” icon
2. The following screen will appear:

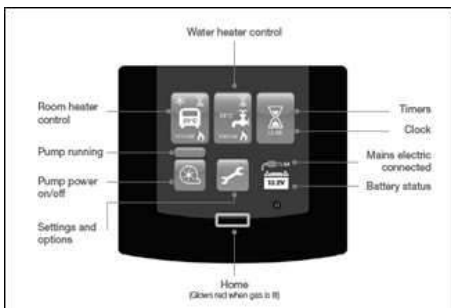

FIG. 3: Space Heater Functions

3. Select the desired heat setting by tapping one of the following icons; the icon will turn red to show it has been activated.

Note: The heater will not operate if the desired temperature is below the current room

temperature.

Icon	Heat Settings	Description
	750W (3.25A)	Low electric setting*
	1500W (6.5A)	High electric setting**
	Gas Only	Gas setting, no electric**
	Gas and 750W	Low gas and electric setting**
	Gas and 1500W	High gas and electric setting**
	Off	Turns heater off

*Night Time Setting: For quiet night time operation and to reduce energy consumption. Select 500W and a lower temperature.

**Maximum Heat Setting: This uses gas and electric simultaneously for higher heat outputs. It intelligently balances between gas and electric settings, varying the heat output accordingly to maintain the selected room temperature.

***Frost Protection Setting: This uses a small amount of power to maintain a very low temperature in the van, reducing the chance of frost damage occurring. Please see page 54 for winterising guide.

4. Select the desired room temperature (ranges from 18°C to 35°C) using the + and - buttons.

5. Once the desired heat setting has been activated, press the home button to return to the home screen.

The home screen will now show the ‘van’ icon in red with the selected heat setting displayed.

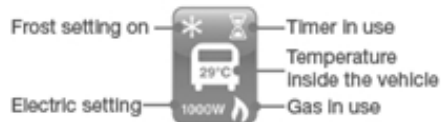

Operating the Water Heater

1. From the home screen, touch the "tap" icon.
2. The following screen will appear;



3. Select the desired setting by touching one of the following icons. The icon will turn red to show it has been activated.

Icon	Heat Settings	Description
	750W (3.25A)	Low electric setting*
	1500W (6.5A)	High electric setting**
	Gas Only	Gas setting, no electric**
	Gas and 750W	Low gas and electric setting**
	Gas and 1500W	High gas and electric setting**
	Off	Turns heater off

*Low electric setting. This uses 750W (3.25A). Unlike the heat boost settings**, the low setting does not operate on a timer, therefore the timer function will remain at 0. When this setting is enabled the water heater will remain CONSTANTLY ON until all water heater settings are turned off. The low electric setting is best used when the vehicle is connected to a mains supply with limited current capacity.

NB: Running several appliances at once will increase the current drawn by the van, which, depending on the rating of the circuit breaker, could trip the supply. If several appliances are running at the same time, the low electric

setting can be used to heat the water but with a reduced current draw. Please note the calculated amp value on the iVan control panel only shows the current drawn by the Whale heating system, and does not measure other appliances within the van.

** Heat Boost settings: There are a number of settings which can be used depending on the desired power/gas usage and the required heat up timer. When using any of these combinations the timer will count down for 15 minutes (default). If a larger supply of hot water is required, over a longer period of time e.g. if 3 or more showers are required in quick succession, the timer function can be changed to 30 mins, 45 mins, 60 mins or forever.

NB: After the boost time has reached 0, the water heater will automatically return to the previous setting.

To change the default timer function, touch the spanner icon on the home screen, then the options icon and use the arrow keys to scroll through to "Water Heater Boost Time" Select the desired boost timer duration using the - and + Note: If "Forever" is selected the water heater will remain CONSTANTLY ON until all water heater settings are turned off.

4. Once the desired setting has been activated, press the home button to return to the home screen.

The home screen will now show the "tap" icon in red with selected heat setting displayed.

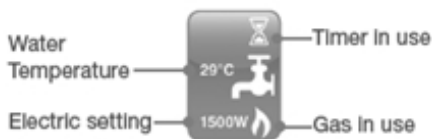

Programming the Timer,

Space Heater Timer:

To set the timer, touch the spanner icon on the home screen then touch Room Timer.



The Space Heater timer may be programmed up to 3 times during a 24-hour period.

Touch the arrow keys to move the cursor along each of the 3 programmable times. Use the + and - to select the on and off time, the desired temperature and the desired power setting. The thermostat ranges from 18°C to 35°C.

Available power settings are:

- Gas Only
- Fan Only
- Gas and 1000W
- 500W
- 1000W
- 2000W
- Off

i The timer function must be adjusted so that the start time is before the finish time.

To activate the timers, press the home button and touch the timer icon. The timer icon will turn red to show that timers are activated.

Turning the Timer Off:

To deactivate the timers, on the home screen touch the red timer icon. The icon will turn blue to show that the timer function has been deactivated.

Water Heater Timer:

To set the timer, touch the spanner icon on the home screen then touch Water Timer.



The Water Heater timer may be programmed up to 3 times during a 24-hour period.

Touch the arrow keys to move the cursor along each of the 3 programmable times. Use the + and - to select the on and off time, and the desired power setting.

Available power settings are:

- Gas Only
- 750W
- 1500W
- 750W and Gas
- 1500W and Gas
- Off

i The timer function must be adjusted so that the start time is before the finish time.

To activate the timers, press the home button and touch the timer icon. The timer icon will turn red to show that timers are activated.

Turning the Timer Off:

To deactivate the timers, on the home screen touch the red timer icon. The icon will turn blue to show that the timer function has been deactivated.

Quick Timer Settings:

The iVan Control Panel will store the last programmed settings. To quickly activate the previously set timers for both Space and Water Heater, touch the timer icon on the home screen. The icon will turn from blue to

red to show that the timer function (with the last programmed settings, for both Space and Water Heater) has been activated.

Operating the Pump

The Whale Watermaster® Exterior Pump works on a pressurised system. This means it will pump up the system until working pressure is reached and then switch itself off. When the pressure drops when a tap is opened, the pump will start to run and will continue to run until the pressure builds up again after the tap is closed.

On the iVan Control Panel you can see if the pump is running by checking the pump icon.

- Blue icon with a grey bar indicates that the pump has been isolated.
- Red icon with a grey bar indicates that pump is turned on but not running.
- Red icon with a red bar indicates that the pump is turned on and running.

Options

There are a number of additional user options that can be adjusted as required.

Menu	Functions	Available Settings
Beep	Enables user to turn the keypad tone on/off	On/Off
Flashing Light	Enables user to turn the home button flashing on/off	On/Off
Mains Supply	Enables user to set the maximum power consumption as determined by the level of mains electric supplied. This function is used to avoid excessive consumption tripping the system	Select between 1 and 16 amps

Brightness	Enables user to adjust the screen brightness	Dim/ Low Dim/ Low Bright/ Bright
Water Heater Boost Time	Enables user to change the water heater boost timer duration	15 mins/ 30 mins/ 60 mins/ forever
Screen Off	Enables the user to select the time before iVan goes into sleep mode, where all settings remain active but the screen is turned off. The screen can be reactivated at any time by pressing the home button	3 mins/ 5 mins/ 10 mins/ 15 mins NB 3 mins is economy.

To enter the options menu from the home screen, touch the spanner icon and then the options icon. Scroll through the available options (see table) using the arrow keys, and select the desired setting using the + and - buttons.

Troubleshooting

iVan is equipped with an electronic diagnostic system which will detect fault conditions ranging from poor gas or DC supply to internal heater malfunctions. In the unlikely event of a failure, an error message will appear with a tap icon to indicate there is a problem with the Water Heater, or a van icon to indicate a fault on the Space Heater. Follow the instructions as outlined below.

Space Heater Diagnostic Screens

Check gas supply



Make sure there is gas in the bottle and no blockage in the gas line. At temperatures below 5°C use propane rather than butane. Press "Retry" once the checks are complete. If there is a problem with the gas supply that cannot be dealt with immediately, select the electric only heating options instead.

Clear / open vents,
Retry after 10 minutes.

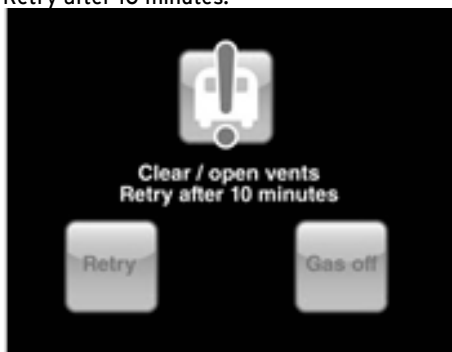

The heater has overheated due to the vents being either closed or blocked, for example with a cushion or a bag. Remove the blockage and open any closed vents. Leave the heater for 10 minutes to cool down, then try again.

Check voltage supply



Ensure voltage is above 12v and below 15v. This can be done by recharging the battery.

Check outside flues for blockages

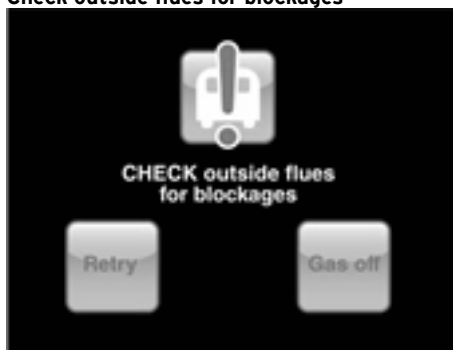

The space heater isn't getting enough air through the flues. Check the flue ends and clear any obstructions away from them.

Fault on space heater

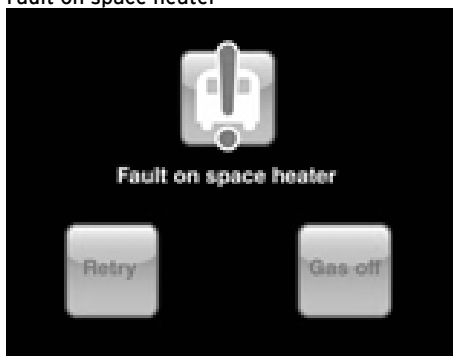

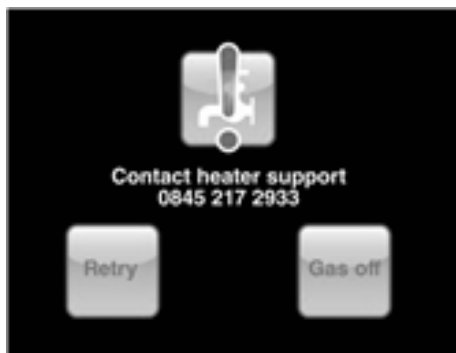

Contact Whale Heater Support on +44 (0)845 217 2933.

Water Heater Diagnostic Screens,

Check gas supply

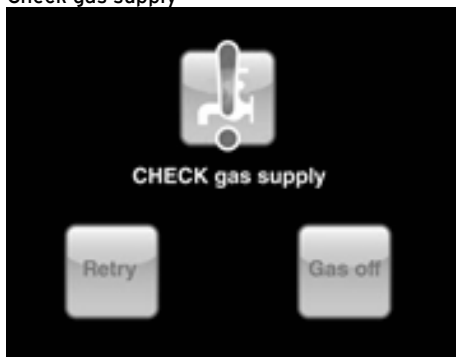

Make sure there is gas in the bottle and no blockage in the gas line. At temperatures below 5°C use propane rather than butane. Press "Retry" once the checks are complete. If there is a problem with the gas supply that cannot be dealt with immediately, select the electric only heating options instead.

Check water supply

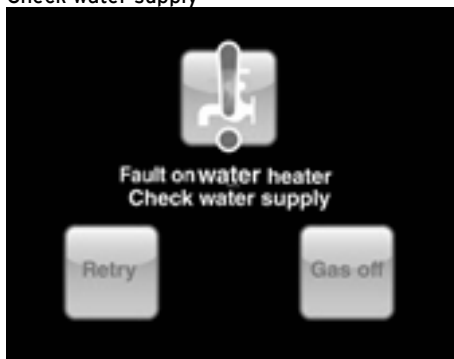

The heater isn't completely full of water. Run the pump with one hot tap open until water flows smoothly out of the tap. Wait at least 5 minutes to allow the heater to fill before pressing "retry".

Check voltage supply

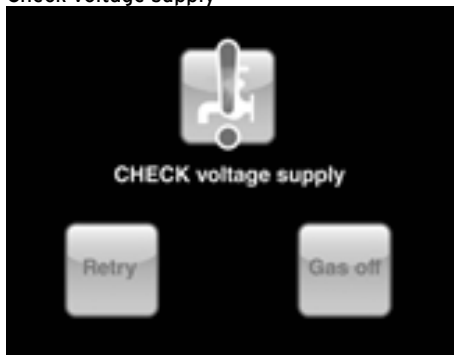

Ensure voltage is above 12v and below 15v. This can be done by recharging the battery.

Fault on water heater

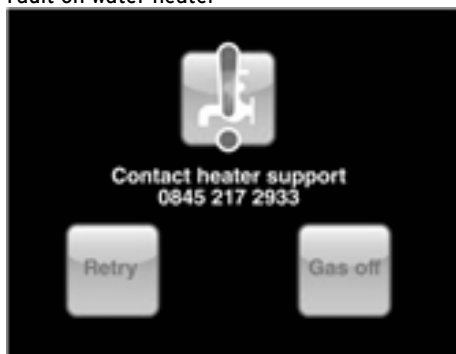

Contact Whale Heater Support on +44 (0)845 217 2933.

Winterising

The iVan® Control Panel will not be affected by the cold; however, there a number of steps that must be taken to fully winterise the Whale® Space and Water Heaters to avoid frost damage occurring.

Frost protection can be enabled on the iVan® Control Panel to maximise protection throughout the winter. Please follow the instructions below:

Space Heater

When using the Space Heater in winter, ensure that the flues are NOT BLOCKED by snow or fallen leaves etc.

When the Space Heater is not going to be used for a long period of time, it is recommended that the open end of the combustion air and exhaust flue are covered to prevent ingress of leaves etc.

Frost Protection

If the caravan is stored with access to a mains connection, the frost protection setting on the Space Heater can be selected. This maintains a very low temperature throughout the van, reducing the chance of frost damage occurring.

To activate: From the home screen, touch the van icon then the frost icon. This will turn red to show frost protection has been activated.



To deactivate: From the home screen touch the van icon, then the frost icon. The icon will turn blue to show that frost protection settings are off.

Water Heater

When using the Water Heater in winter, ensure that the flues are NOT BLOCKED by snow or fallen leaves etc.

When the Water Heater is not going to be used for a long period of time, ensure the heater is fully drained to prevent frost damage. To drain the water heater: switch off the water pump, open all hot water taps and operate the drain valve fitted in the system. The drain valve should be left in the open position to ensure that all the water drains out.

Watermaster® Pump

Please refer to winterising instructions for the pump model you have installed. Contact Whale® Support for specific information on +44 (0)28 9127 0531.

For advice or information on your Whale® Space Heater, Water Heater or iVan® please contact Whale® Heater Support:

Tel: +44 (0)845 217 2933

E-mail: ivan@whalepumps.com

Please note that by contacting Whale® Support you will be indicating your consent to receive product updates, recall information, help guides and appropriate marketing messages from Whale® via post, e-mail or telephone unless you indicate an objection to receiving such messages.

THE PURSUIT CONTROL PANEL

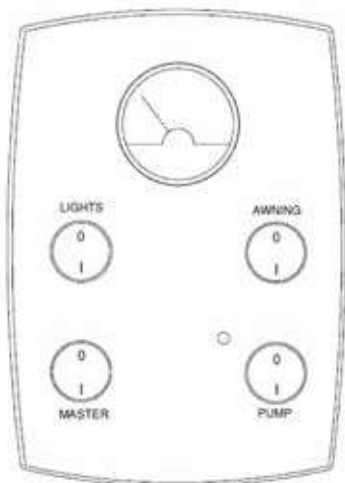

The Pursuit Control Panel is designed to send and receive simple signals to control the caravan.

1. **Master switch:** The master switch will turn on and off all the habitation power except circuits connected to the permanent supply from the battery.
2. **Lights switch:** The lights switch will turn on and off all the habitation lights and also the awning light.
3. **Awning switch:** The awning switch will turn on and off the awning light if the lights switch is on.
4. **Pump Switch-** The pump switch will turn on and off the power to the pump which goes through a pressure switch, the pump will only run when the pressure drops. An LED on the control panel will illuminate when the pump is running.
5. **Volt meter:** The volt meter gives an indication of the voltage of the battery when disconnected from the mains supply and an indication of the charging voltage when connected to the mains supply.

20. UNICORN SOLAR DUAL BATTERY CHARGER SDC 10/20

The solar module generates power when light is cast on it. The full voltage is also available even if there is little light. The solar automatic charger only serves to charge 12v (24v) lead accumulators comprising 6 (12) single cells (e.g. caravan battery) with a capacity of 50-100Ah (SDC 10) or 50-200Ah (SDC 20) The preferred application fields for the automatic charger are batteries with gel, AGM (Absorbed Glass Mat) or liquid electrolyte.



The device is not suitable for charging:

- 6v batteries or 6v lead accumulators
- Non-chargeable batteries
- Nickel-cadmium batteries

The device is only suitable for regulating solar modules. Do not connect any other voltage sources (e.g. main voltage 230v) to the device. This may destroy the device and/or sources. If any other voltage sources are used together with the device, please ask your retailer.

Operating Instructions

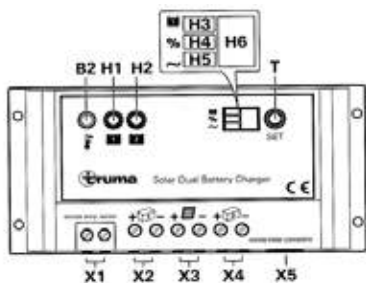

- H1 LED: Function display battery 1
 H2 LED: Function display battery 2
 H3 LED: Battery type- AGM, gel, liquid
 H4 LED: Charging current distribution
 H5 LED: PWM charging frequency
 H6- shows the values of H3, H4, H5 as numbers
 T Query/change operating mode
 B2 Internal Temperature sensor
 X1 Connection for temperature sensor B1
 X2 Connection for battery 1
 X3 Connection solar module
 X4 Connection for battery 2
 X5 Connection (RJ-45) for remote display (optional)

Function

The device has a modern microprocessor-controlled pulse with modulated three-phase charging characteristic. This allows high performance combined with a light weight and small dimensions. By virtue of the high-quality electronics, it works highly efficiently. The automatic charging process preserves the device and does not overcharge the batteries. This in turn extends the service life of the batteries significantly. It is suitable for batteries with liquid, gel or AGM technology and has a settable charging current distribution for two separate battery connections.

The device is designed for continuous operation and parallel mode. Consumers can be continuously connected, switched on or disconnected. Consumers are supplied and the batteries are charged at the same time. The consumer current here should be smaller than the solar charging current as otherwise the battery will not charge.

If the device is operated in conjunction with an external temperature sensor for the supply battery (battery 1), the device regulates the charging voltage automatically depending on the battery temperature. This ensures particularly effective and gentle charging of the battery. If an external temperature sensor is not used, the device regulates the charging process based on the internal temperature sensor.

The supply and starter batteries can be charged by connecting one or several solar modules. Please observe the maximum voltage and power consumption values.

Charging process

The device has an electronic reverse voltage, reverse current and solar short-circuit protection. The charging current is only released if the battery is connected correctly and there is enough power available from sunlight. When a temperature sensor is used, charging takes place on a temperature-dependent basis.

Bulk phase

Charging with maximum available solar charging current until the charging end voltage is reached.

Absorption phase

The charging current is kept for a period of 2 hours. At the end of this period, it changes to the float phase.

Float phase

The charging voltage is set to 13.8v. The charging current drops to the value necessary to compensate the self-consumption of the battery. Power is still supplied to the consumers. If the consumed current exceeds the available solar charging current, the charging process can no longer be maintained. If the battery voltage drops below 13.3v, the device automatically switches to the bulk phase, if there is adequate solar charging current.

Equalisation charging phase (only for AGM and liquid electrolyte battery type)

The equalisation charging phase serves to compensate the cell voltages and can reduce any sulphation. If the voltage of the battery drops below 11.1v, it is assumed that the battery has deep-discharged. The device is switched to the equalisation charging phase for 2 hours. At the end of this period, it changes automatically to the float phase.



Deep-discharged batteries can be permanently damaged. Equalisation charging cannot repair this. Use a Truma battery monitor to prevent deep-discharging.

- Liquid electrolyte batteries can create explosive gases, so ensure there is adequate ventilation.
- Check the liquid level at regular intervals. Overcharging can damage your battery; check the technical data for your battery.
- Equalisation charging increases the charging voltage; this may damage the consumer. Ensure that all consumers are designed for these voltages.

Parallel mode

If load current is consumed while the battery is being charged, it is served from the available solar charging current. If the consumed current exceeds the available solar charging current, the device cannot charge the battery. The device starts charging automatically once an adequate amount of solar charging current is available again.

Settings;

Operation

The display H6 shows different system settings. Press the key (T) to switch between LED H3, H4 and H5 and display this in H6. If the key is pressed again, the system starts at LED H3 again.

Battery type

The battery type can only be set for battery 1; battery 2 is assumed to be the same battery type.

Query

- Press (T) until LED H3 illuminates; the saved value is shown in display H6.

Display	H6 Battery Type
1	Gel (pre-setting)
2	AGM
3	Liquid (liquid electrolyte)

Change

- Press key (T) for 5 seconds until the display H6 flashes.
- Press the key (T) to set the required value.
- If the key is not pressed for 5 seconds, the displayed value will be saved and flashing stops.

Charging current distribution

The charging current distribution between battery 1 and battery 2 can be set. The following distributions can be selected.

Query

- Press (T) until LED H4 illuminates; the saved value is shown in display H6.

Display H6	Battery 1	Battery 2
0	0%	100%
1	10%	90%
2	20%	80%
3	30%	70%
4	40%	60%
5	50% (pre-setting)	50%
6	60%	40%
7	70%	30%

8	80%	20%
9	90%	10%

Change

- Press key (T) for 5 seconds until the display H6 flashes.
- Press the key (T) to set the required value.
- If the key is not pressed for 5 seconds, the displayed value will be saved and flashing stops.



During the normal charging process, the device divides the charging current between battery 1 and battery 2 as set. Once battery 1 is fully charged, all the charging current is fed to battery 2, regardless of the set value. If the voltage of battery 1 drops, the charging process starts again. If only battery 1 is connected, the entire charging current is supplied to this battery regardless of the set value.

PWM charging frequency

The pulse frequency of the device can be set here. This may be changed to reduce possible interferences.

Query

- Press (T) until LED H5 illuminates; the saved value is shown in display H6.

Display H6	PWM charging frequency
0	25Hz (pre-setting)
1	50Hz
2	100Hz

Change

- Press key (T) for 5 seconds until the display H6 flashes.
- Press the key (T) to set the required value.
- If the key is not pressed for 5 seconds, the displayed value will be saved and flashing stops.

Function display / Troubleshooting

LED H2 shows the status of battery 1.

Battery 2 double the values of the 12v- to work out the 24v values

Display	Cause/Rectification
LED flashes	Check connections from the device to the battery and solar module, ensure that they are connected to the right terminals. Test the fuse, solar module and battery
LED flashes in longer intervals	Battery is fully charged
LED shines	The battery is being charged
LED flashes in short intervals	The battery is not being charged. If necessary, replace faulty battery
LED does not shine	Battery not connected or over-voltage

If this does not solve the problem, please contact the Truma Service.

Repairs

Do not repair or modify the solar panel. Please contact your retailer or the Truma Service.

Keeping your Bailey Caravan
Nice & Cool in Summer
Cosy & Warm in Winter

with Springvale EPS
sustainable insulation products

Lifetime Performance • Environmentally Friendly • Outstanding Insulation Values



Visit www.springvale.com
to view our detailed solutions.

springvale

Sustainable insulation values

20. HEATING SYSTEMS

ALDE HEATING SYSTEM



Always replace the heat transfer fluid (HTF) in accordance with the antifreeze product's lifespan. If in any doubt, replace the HTF after 2 years.

The corrosion inhibitors found in ethylene glycol antifreeze may not be cross-compatible. When topping up or replacing the HTF, ensure the new antifreeze is compatible with the current antifreeze product. Read the product label or contact the product manufacturer for details.

Operating Instructions: 3020 Compact High Efficiency Boiler



Alde can accept no liability whatsoever for damage or injury resulting from failure to observe these instructions.

Specified Use

These instructions are approved for the Alde 3020 Compact HE boiler fitted in caravans, motorhomes or buildings in accordance with CE 0402 no. SC0653-13, and have the E5 mark for installation in vehicles in accordance with ECE R122, no. 00 001 and R10, no. 04 166, for use in central heating and hot water systems.

The boiler is not intended for use by persons (including children) with reduced physical, sensory or mental capabilities, or lack of experience and/or knowledge, unless they have been given instruction or are supervised. The term "specified use" also covers observance of the operating and installation instructions.

The Alde 3020 Compact HE boiler must be installed or repaired by a competent person in accordance with current local regulations.

In the unlikely event that your boiler develops a fault, switch off the boiler and contact Alde, or your dealer or installer.

Operating and installation instructions for the Alde control panel are supplied separately.

The owner is always responsible for maintenance and arranging inspection.

Boiler Design

The boiler's internal heat exchanger consists of three concentric cylinders: the combustion

chamber, the central heating cylinder and the hot water cylinder.

The combustion chamber is made from aluminium, and is divided into two halves by a baffle plate, with the burner head located in the top half, and the flue gases venting through the bottom half.

The combustion assembly is fixed to the end of the internal heat exchanger. It consists of the burner, combustion fan, gas valve, air intake and exhaust ducts, and gas line.

Two electric heating elements are sealed inside the central heating cylinder, one for 1kW, one for 2kW.

Description of Functions

Gas Heating

When gas heating is set to "On" the combustion fan starts to revolve. Once the correct speed is achieved (in rpm), a signal is sent to the PCB (Printed Circuit Board) for the burner to be lit. The gas valve opens, passing gas, and the ignition module on the PCB generates sparks at the electrode on the burner head.

When the burner ignites, a flame supervision device (FSD) signals the ignition module to cease sparking. The burner fires until the boiler or room thermostat reach the set-point. Should the burner flame out unexpectedly, the FSD detects this and attempts to reignite (for about 10 seconds), before shutting down and raising a fault code.



Listen carefully to the ignition sequence of the boiler. You should hear the whirl of the combustion fan, the clunk of the gas valve and the tick-tick of the ignition module.

Electric Heating

When electric heating is set to 1, 2 or 3kW, relays on the PCB trip, feeding the 230 v supply to the electric heating elements. These are controlled by the same programme as the gas heating.

Domestic Hot Water

The combi-type boiler automatically produces hot water. Heat is emitted from the central heating cylinder into the hot water cylinder. If the hot water cylinder is empty, the air is heated but no damage can result.



In a good summer, for example, lower the desired temperature on the control panel to around 10°C. The central heating will not circulate (unless the temperature drops to 10°C), but you will still have hot water. The boiler must not be switched on if there is no heat transfer fluid (HTF) in the system.



- Always drain down the freshwater system if there is risk of frost; in winter, for example. You may continue to use the boiler with no freshwater in the system, as required; no damage can result.
- Always replace the HTF in accordance with the antifreeze product's lifespan. If in any doubt, replace the HTF after 2 years.
- Only sterilise the freshwater system with a product suitable for stainless steel.
- Do not place stowage in the boiler compartment.
- Do not position awnings, tents or other enclosures around the flue terminal.
- Do not obstruct the flue. Be careful not to flood the flue when washing the vehicle.
- The gas heating must not be used when refuelling the vehicle at the service station or related facility.

Being a combi-type boiler, the Alde 3020 Compact HE has an integrated, stainless steel hot water cylinder that holds approximately 8.4 litres of freshwater.

The boiler can produce around 12 litres of 40°C warm water per 30 mins (at a cold water temperature of 10°C). If only the electric heating is used, this capacity is slightly reduced.

The hot water should not be used for drinking or cooking.

Always flush out the hot water cylinder before use, especially when it has stood empty for some time.



Any steriliser products should be suitable for use with stainless steel.

Avoid steriliser products containing sodium hyperchlorite, for example, as these will cause severe corrosion damage to the hot water

cylinder, which is not covered under warranty. Read the product label or contact the product manufacturer for details.



Alde recommends the Truma AquaStar steriliser products.

When the hot water cylinder is in continuous use, it should be drained and refilled once a month. This recreates the air cushion in the hot water cylinder that absorbs pressure surges.



If continuously using the hot water cylinder in a hard water area, fit an inline scale inhibitor to minimise the effects of limescale.

Target hot water temperature is greater than 50°C in normal operation, to prevent the growth of Legionella. Over 50°C, the hot water will be heated to the maximum achievable temperature at the time. This allows the hot water to achieve disinfection temperatures, and increases warm water performance.

If scalding hot water temperatures are a concern - such as with the young, elderly or infirm - thermostatic mixing valves (TMVs) can be fitted, and may be required by local regulations.



Alde recommends fitting the 3102-002 high temperature TMV.



Always drain down and completely empty the hot water cylinder when there is risk of frost, unless the vehicle is explicitly stated to be self-winterising by the vehicle manufacturer.

Failure to drain the hot water cylinder when there is a risk of frost may result in frost damage, which is not covered under warranty.

Draining Freshwater

1. Switch off the water pump.
2. Open all water taps, showers, etc.
3. Open the safety/drain valve by lifting the yellow tab (Fig.1 [M]): see page 62, or by turning the blue knob (Fig 1.[K]) 90°.
4. The system will drain directly below the vehicle through the clear plastic hose on the safety/drain valve. Check that all water has emptied out (7-10 litres). Leave the valve in the open position until the next time the hot water cylinder is used.

NB: Check that the red breather valve (Fig.1 [N]) is allowing air to enter the hot water cylinder, when it is being drained, and that the clear plastic hose is not obstructed.

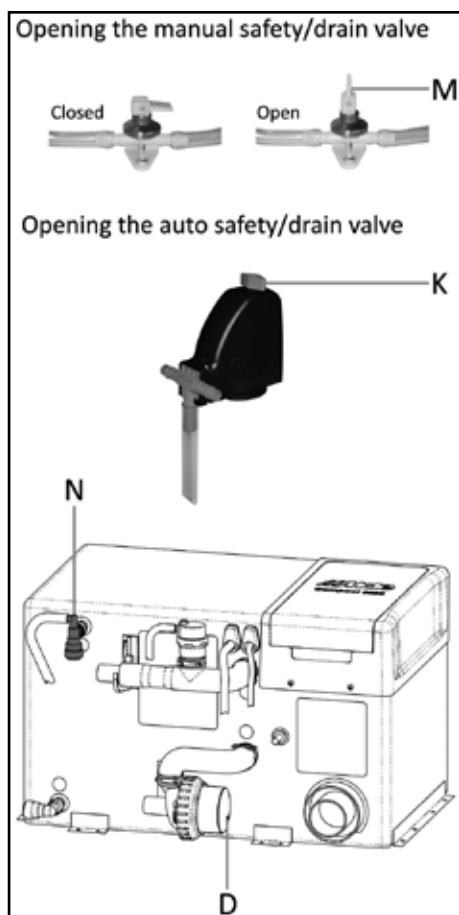

Fig.1

Heat Transfer Fluid

The central heating system is filled with heat transfer fluid (HTF), a solution of 50% ethylene glycol antifreeze and 50% water.



The boiler must not be switched on if there is no HTF in the system.

The antifreeze manufacturer will have a maximum water hardness recommendation. Read the product label or contact the product manufacturer for details.

Alde recommends antifreeze meeting VAG G12++ or G13 specification, and deionised water (0 ppm).

50:50 ethylene glycol antifreeze and water will protect against frost down to -35 to 37°C. A refractometer and/or hydrometer can be used to measure the strength of the antifreeze solution.

Corrosion protection will vary depending on the lifespan of the antifreeze. Read the product label or contact the product manufacturer for details.



Always replace the HTF in accordance with the antifreeze product's lifespan. If in any doubt, replace the HTF after 2 years.

The corrosion inhibitors found in ethylene glycol antifreeze may not be cross-compatible. When topping up or replacing the HTF, ensure the new antifreeze is compatible with the current antifreeze product. Read the product label or contact the product manufacturer for details.



As a rough guideline, blue and red antifreeze products are not compatible with each other, but VAG G12++ and G13 spec antifreeze (purple/magenta) is compatible with both.

Failure to fill with suitable HTF may result in severe damage to your Alde system, which is not covered under warranty.

Filling

The central heating system is filled with HTF through the expansion tank, either by hand, or using the Alde service pump. Any containers used for handling or storing the HTF should be checked first, and must be visibly clean to avoid introducing contaminants or foreign

objects into the system.

Alde recommends using the Alde 1900-811 or 839 twin-motor service pump to fill the system.

To fill the system by hand, unscrew the expansion tank cap (Fig.2 [R]), and lift the circulation pump (Fig.2 [S]) out of the tank (if applicable). Carefully pour the HTF into the tank, and repeat until the fluid level is about 1 cm above the MIN mark when cold.

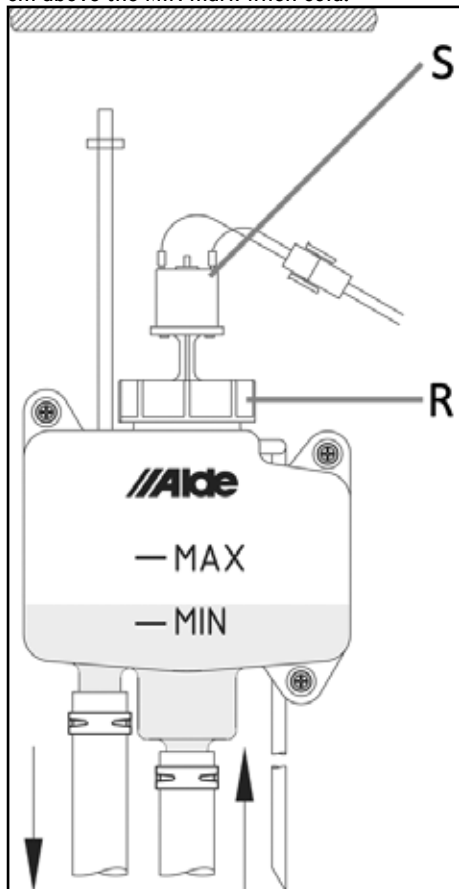

Fig. 2

Central Heating

The boiler is set to an upper limit temperature of 85°C, i.e., the temperature of the heat transfer fluid (HTF) as it circulates around the pipes, radiators, convectors, etc.

To ensure the best performance from hydronic heating, air must be able to circulate freely around the back of the furniture (Fig.3). Air

vents, cut into the top and bottom of the furniture, must be unobstructed by carpets, cushions, or stowage, etc.

The full length of a convector should be ventilated for best performance.

i Use gas and electric heating simultaneously for the best performance. The boiler will only use as much energy as is needed, and is 93% efficient on a SEDBUK (seasonal efficiency of domestic boilers in the UK) based test.

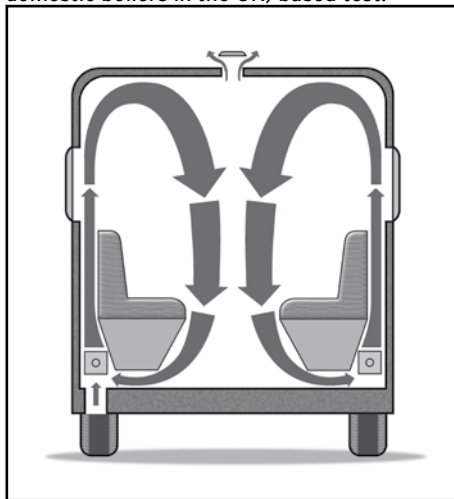

Fig 3

Circulation Pump

A pump is used to circulate the HTF around the central heating system. There are three models of Alde circulation pump.

- 12v expansion tank circulation pump. This light duty pump is ideally suited for holiday-makers, or as an off-grid option for the 230v inline circulation pump.
- 12v inline circulation pump. This heavy duty, variable speed pump is designed for all year round motorcamping.
- 230v inline circulation pump. This heavy duty pump is powered directly by mains electric, suitable for non-touring vehicles.

Bleeding Air

The HTF will contain some air. This is unavoidable. Air bubbles can also be introduced when the system is filled.

In a newly filled central heating system, you will need to bleed air from the bleed points

to ensure best performance. There is an automatic air bleed valve on the boiler. There is also an air vent on the expansion tank. The installer should fit bleed points elsewhere in the system, especially where the pipes step up and down, and on radiators and towel rails. Air will accumulate at these high points and become trapped.



Contact the dealer or installer for details on where the bleed points are in your system, and how to access them.

To bleed the system, set the desired temperature to 30°C and select gas heating on the control panel.

Set the 12v inline circulation pump on the side of the boiler to speed 5 (Fig.1 [D]): see page 62, by turning the blue speed dial clockwise, on the face of the pump motor. NB: Speed is not adjustable if using the 12v circulation pump fitted in the expansion tank.

After 10 mins, set the pump back to its normal running speed (2 for a caravan, 3 for a motorhome).

Now power off the Alde 3020 Compact HE boiler completely, making sure that the circulation pump is not active.

Follow the flow pipe from the boiler, and bleed the system at each bleed point.

If Alde bleed points have been fitted, these are metal bleed screws mounted on black EPDM rubber connectors (Fig. 4). Have a cloth in hand. To open, turn the screw anti-clockwise between thumb and forefinger. Air will hiss out. When fluid trickles out, close the bleed screw and mop up fluid with the cloth.



Fig. 4

Move on to the next bleed point and repeat, until all bleed points have been attended to.

Air Lock

If enough trapped air accumulates at one point, an air lock can result and prevent the circulation of hydronic heating.

A ramp or steep slope can be used to raise one end of the vehicle, causing the trapped air to shift around the system. Repeat the full bleed procedure. A caravan can be slowly and carefully tilted to reproduce this effect.

To clear a stubborn air lock in under 15 minutes, an Alde-certified service agent can use the Alde 1900-811 or 839 twin-motor service pump.

230v Electric

The Alde 3020 Compact HE boiler has two 230v electric heating elements, outputting 1050W and 2100W, or 3150W combined, and drawing 5A, 9A, and 14A respectively (rounded).

230v breakers, fuses, fused spurs and isolator switches should be rated for 16A.

Before using electric heating, check the current limit on the electric supply you are hooking up to.

- 6A limit, only use 1kW electric heating.
- 10A limit, use 1-2kW electric heating.
- 16A limit, use 1-3kW electric heating.

NB: If the electric supply has unstable voltage, the amperage will also fluctuate.



Alde recommends fitting the 3010-246 load monitor, allowing you to set a limit on the current drawn by the vehicle and the electric heating to automatically accommodate it.

LPG

LPG (liquefied petroleum gas) has two main variants, propane and butane gas. The gas heating in your Alde 3020 Compact boiler can use propane or butane gas as fuel. Many LPG fuels contain a mixture of propane, butane and other additives.

BS 5482 Part 1 states, "For butane cylinders, satisfactory service might not be obtained at temperatures of less than 10°C; the most suitable temperature range is from 13°C to 30°C. For temperatures less than 13°C, the use of propane should be considered."

For this reason, Alde recommends using propane gas for all year round gas heating.

LPG cylinders contain both gas and liquid forms. When the cylinder is filled, high pressure transforms the gas into liquid. The liquid reverts to gas when the valve on the cylinder is opened.

LPG is a flammable gas. It can be a fire and explosion hazard if stored or used incorrectly. Store cylinders vertically and securely, to prevent them from toppling.

Do not mount your LPG cylinder horizontally or use liquid phase gas cylinders. Liquid-gas explosion may result. Read the product label or contact product manufacturer for details.

LPG is heavier than air. Should a gas leak occur, floor vents in a caravan or motorhome should allow the gas to escape from the vehicle. For this reason, always ensure floor vents are unobstructed.



The boiler compartment contains the gas connection, floor vents and the flue hoses. Do not place stowage in the boiler compartment.

In the event of a gas leak, or if you smell gas:

- Extinguish all naked flames.
- Open all doors and windows.
- Close all gas valves, including the valve on the cylinder.
- Do not smoke.
- Do not operate any electrical appliances or switches.
- Arrange for immediate inspection of the

gas system by a competent person in accordance with current local regulations.

LPG from the cylinder is reduced in pressure by a regulator, and is supplied to the boiler at low pressure (30mbar). Never use an unregulated high pressure supply.

Where oil and dirt in the gas supply are a concern, gas filters should be fitted to prevent blockage of the boiler gas valve.

NB: Gas heating must not be used while driving your vehicle unless a safety shut-off device is fitted to the gas system. Current local regulations must be adhered to.

Flue

The burning of LPG produces CO₂ (carbon dioxide), a non-toxic, asphyxiant gas.

Exhaust flue gas can cause possible burns and poisoning. Avoid inhaling exhaust flue gas.



Do not position awnings, tents or other enclosures around the flue terminal.

Air supply is essential for clean combustion. The air intake is located in the flue terminal. For best performance, the flue terminal should be well vented. If leaving the gas heating unused for a period, ensure the flue terminal is covered to prevent pest animals nesting in the flue.



Do not obstruct the flue. Be careful not to flood the flue when washing the vehicle.



The gas heating must not be used when refuelling the vehicle at the service station or related facility.

Maintenance

There is no manufacturer's service requirement for the Alde 3020 Compact HE boiler itself. Current **local regulations must be adhered to.** The installation of the boiler should be inspected annually for gas safety. LPG hoses should be regularly checked for signs of damage and should be replaced, at maximum, after 3 years of use.

Bleed air from the system when newly filled, when the vehicle has been standing unused for a period, and before departing on holiday.

The fluid level in the expansion tank should

be about 1cm above the MIN mark when cool. The heat transfer fluid (HTF) should be topped up if below this level, to prevent a break in circulation. Only top up with compatible HTF. NB: Never leave the system empty of HTF.

Always replace the HTF in accordance with the antifreeze product's lifespan. If in any doubt, replace the HTF after 2 years.

Failure to maintain the condition of HTF may result in frost and/or corrosion damage, and is not covered under warranty.

When the hot water cylinder is in continuous use, it should be drained and refilled once a month. This recreates the air cushion in the hot water cylinder that absorbs pressure surges.

Winter

When camping in the winter, always ensure the flue terminal remains unobstructed by snow and ice. Extensions for roof flue terminals, and condensate spouts for side flue terminals are available from Alde.

Check the strength of the HTF (heat transfer fluid) with a hydrometer and/or refractometer. It should measure 50% ethylene glycol antifreeze, or -35 to 37°C.

The central heating can still be used with no freshwater in the system. The air in the hot water cylinder is heated but no damage can result.



Always drain down and completely empty the hot water cylinder when there is risk of frost, unless the vehicle is explicitly stated to be self-winterising by the vehicle manufacturer.

If camping in temperatures below -10°C, consider carrying spare parts in the event of an emergency. Alde recommends a 12v circulation pump for the expansion tank (with cabling), a PCB, and 4-5 litres of ready to use antifreeze. These spare parts should be kept well insulated and in the warmest part of the vehicle; for example, in the wardrobe, near to the expansion tank pipes.

If storing the vehicle for winter, ensure the flue terminal is covered to prevent pest animals nesting in the flue.

If using the light duty 12v circulation pump in the expansion tank, do not leave the central heating on over winter, even with a low desired temperature set.



Air the vehicle over winter without wearing out the light duty pump. Use the programmable Alde control panel to automatically heat the vehicle for 24 hours, once a week.

Troubleshooting

The Alde control panel will display any error messages. See the operating and installation instructions supplied separately.

temperature within an hour, in non-extreme conditions.

If problems persist, please contact Alde, or your dealer or installer.

The system is completely dead, the control panel is blank

- Check the 20mm T3.15 amp glass fuse in the boiler. This is located under the lid of the black plastic service hatch, in a green plastic fuse holder.
- Check the 12v supply to the boiler, it should be above 12v.
- Check the 12v cable is plugged into the boiler. Check the cable is plugged into the Alde control panel.

The boiler will not ignite on gas

- Check the gas cylinder is full. Try a different gas cylinder, ensuring it is propane gas.
- The system may not need to use gas heating, if also using electric heating.
- The fluids in the boiler may already be at operating temperature.

The boiler will not heat on 230v electric

- Check that any 230v isolator switches are on (they will often have an LED indicator).
- Check the 230v supply to the vehicle.
- The fluids in the boiler may already be at operating temperature.

No hot water

- Check that "hot water ignore" is not activated on the Alde control panel.
- Check that constant pumping is not activated on the Alde control panel.
- Check for other conflicting settings on the Alde control panel.
- Check the freshwater supply and water pump.

No central heating

- Bleed the system of air.
- Check the fluid level in the expansion tank.
- Check that the circulation pump is responding.
- Check that "hot water boost" is not activated on the Alde control panel.
- Use gas and electric heating.
- Check that vents in the furniture are not obstructed.
- Check the condition of the heat transfer fluid.
- Most vehicles will reach a comfortable

Warranty

Alde undertakes to rectify any manufacturing defect or early component failure through normal use that occurs within 12 months of the installation date.

If your Alde boiler develops a fault, your first action should be to contact your dealer or installer, as they will be familiar with your installation and vehicle, and how to make a claim under warranty.

Alde International (UK) Ltd
Huxley Close
Park Farm South
Wellingborough
Northamptonshire
NN8 6AB

Tel. +44 (0) 1933 677765

www.alde.co.uk

Quick Start Guide : 3020 113 Colour Touch

This quick start guide allows end users to confidently use the core features of their Alde control panel. See the operating and installation instructions for the Alde control panel for more details.

 Please read the operating instructions for the Alde 3020 Compact HE boiler before using the system.

Starting the System



- Both the control panel and boiler are off.
- To start the system, press the Power button on the control panel. The Splash Screen is displayed and green LED is lit. The boiler will now start with the previously saved settings (factory settings by default). The system will now be drawing variable 0.2-1A of current from the 12v supply.

Standby Screen

The Standby Screen is displayed after the Splash Screen. This screen contains useful information about the status of your heating system.

NB: If Standby Screen is set to "Dark" in Backlight settings, the Standby Screen will not be displayed; the screen will be dark unless touched.

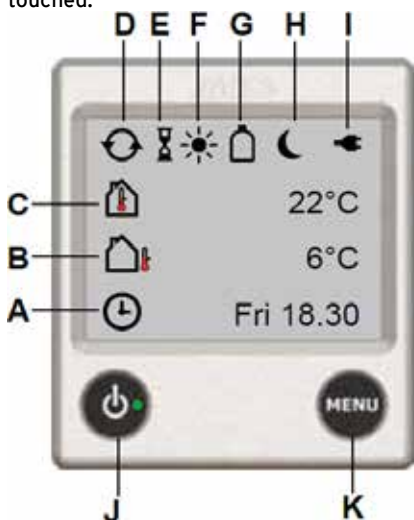

- A. Clock is enabled. Day of the week and time shown.
- B. Outdoor temperature. [Optional outdoor temperature sensor required.]
- C. Room temperature. Measured at the control panel. [Optional discrete room temperature sensors available.]
- D. Central heating circulation pump is active.
- E. Delayed Start/Cycle is enabled.
- F. Day Mode active.
- G. Gas Cylinder Status. Full/empty and active EisEx shown. [Additional accessories required.]
- H. Night Mode active.
- I. 230 V supply. If not displayed, the boiler is not receiving 230 V supply.
- J. Power button. Press to switch system on

and off. Lit green LED indicates system is on. K. MENU button.

L. Press to access Main Menu from Standby Screen or Settings Menu.

Main Menu

Press MENU button to access the Main Menu from the Standby Screen or Settings Menu. The screen will revert to the Standby Screen after 30 secs if untouched.

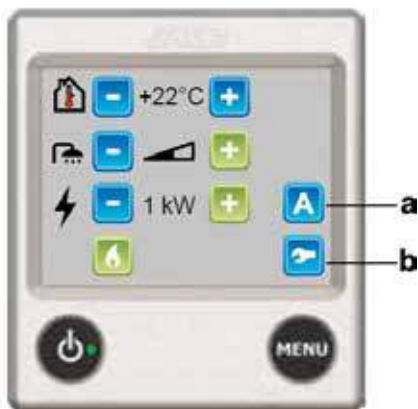

- Standby Screen. Press MENU button.
- Main Menu.
 - a. What's Activated Menu. [Not displayed if no activated functions are detected.]
 - b. Settings Menu.

Desired Room Temperature

The desired room temperature can be set from 5°C to 30°C, in 0.5 increments.

i The World Health Organisation recommends a room temperature of 18-24°C for healthy living.

NB: If Day or Night Mode are active, the temperature cannot be adjusted, and the Plus and Minus buttons will be greyed out.

- The current desired room temperature is displayed.
- Adjust by pressing Plus or Minus button.

Domestic Hot Water

The Alde boiler stores 8.4 Litres of hot water as standard. If the hot water cylinder is empty, the air is heated but no damage can result.

i In a good summer, for example, lower the desired temperature on the control panel to around 10°C. The central heating will not circulate (unless the temperature drops to 10°C), but you can still control hot water.

NB: If Day or Night Mode Sans Hot Water are active, the hot water cannot be adjusted, and the Plus and Minus buttons will be greyed out.

- Hot Water Ignore. Volume bar empty. No attempt is made to heat hot water specifically. This saves energy when the freshwater is drained down.
- Hot Water Normal. Volume bar half-full. Hot water is heated to greater than 50°C. NB: If circulation pump is set to Continuous, this option will not be available.
- Hot Water Boost. Volume bar full. Central heating circulation is disabled for 30 mins. Hot water is heated to greater than 65°C. After 30 mins the system reverts to Hot Water Normal.
- Adjust by pressing Plus or Minus button.

Electric Heating

Check that 230v supply is displayed on the Standby Screen. The Alde boiler is programmed to use power economically and there are times when it may use no power at all, even if set to 3kW.

- Select Off, 1, 2 or 3kW electric heating. More power equals better performance, but may be restricted by the current (amps) limit on the electric hook-up.
- Adjust by pressing Plus or Minus button.

Max current draw from 230v supply is 4.5A on 1kW, 9A on 2kW, 14A on 3kW. If the electric supply has unstable voltage, the amperage will also fluctuate.

Gas Heating

The Alde boiler is programmed to use power economically. The gas burner has two stages, shifting dynamically between low or full flame. There are times when it may use no power at all, even if gas heating is selected.

- Press the Flame button to select gas heating. Green is on, blue is off.

Use both gas and electric heating for best performance.

Shutting Down the System

To save energy, the control panel only updates the boiler after the last adjustment is made. Wait 10 secs before shutting down the system to ensure the boiler is updated.

- Press the Power button again. The screen goes dark, the green LED is unlit. The system is off.

Setup

Most UK installations do not need setting up in the Settings Menu, and use default factory settings.

Restore Default Factory Settings

Before using the system for the first time, restore default factory settings. Your control panel may have been tested by the dealer or installer, and some settings may have been changed.

1. Press Tool button to access the Settings Menu (bottom right in Main Menu).
2. Press down arrow, until Reset button is displayed.
3. Press the Reset button to proceed.

Setup Expansion Tank Pump

To use the 12v circulation pump in the expansion tank, you must set it up. This is not a default factory setting.

NB: Under factory settings, the system will use the 12v inline circulation pump by default.

1. Press Tool button to access the Settings Menu (bottom right in Main Menu).
2. Press down arrow, until Circulation Pump button is displayed.
3. Press Circulation Pump button, select Expansion Tank Pump to proceed.

Set up Antimicrobial Function

To actively kill Legionella, set up the Antimicrobial function. At 2:00 every night, the hot water will be heated to over 65°C for 30 mins. This further reduces the risk of Legionella.

1. Press Tool button to access the Settings Menu (bottom right in Main Menu).
2. Press down arrow, until Antimicrobial button is displayed.
3. Press Antimicrobial button to proceed.

Setup Standby Screen for Bedtime

The backlight on the Standby Screen can be disturbing if the control panel is visible from your bed. It can be inverted for white text on black background.

1. Press Tool button to access the Settings Menu (bottom right in Main Menu).
2. Press down arrow, until Backlight button is displayed.
3. Press Backlight button, select Inverted to proceed.

Maintenance

The Alde control panel requires no maintenance, other than cleaning of the screen as needed. Use a microfibre cloth to clean the touchscreen.

NB: Consider removing the Alde control panel over winter, if the vehicle is to be kept in storage and is susceptible to damp.

Troubleshooting

Any error messages will be displayed on the Standby Screen. Error messages can be cleared by switching off 12v supply to the boiler for 10 secs.

The system is completely dead, the control panel is blank

- Check the 20mm T3.15Amp glass fuse in the boiler. This is located under the lid of the black plastic service hatch, in a green plastic fuse holder.
- Check the 12v supply to the boiler, it should be above 12v.
- Check the 12v cable is plugged into the boiler. Check the cable is plugged into the Alde control panel.

“Panel failure 1” & “Panel failure 2”

- Moisture is trapped in the control panel.
- Remove the Alde control panel from the vehicle and air in a warm, dry place overnight.

“Gas failure”

- Out of gas or gas is not igniting.
- Check the gas cylinder is full. Try a different gas cylinder, ensuring it is propane gas.

“Overheat red fail” or “Overheat blue fail”

- Bleed the system of air.
- Check the fluid level in the expansion tank. It should be 1cm above min mark when cool.
- Check the circulation pump is responding.
- Wait 15 mins for the fluid to cool down.

“Overheat PCB”

- Failsafe in boiler has triggered.
- Check the fluid level in the expansion tank. It should be 1 cm above the Min mark when cool.
- Check the boiler compartment is ventilated, and that the vents are unobstructed. Do not place stowage in the boiler compartment.

"Fan failure"

- Combustion fan speed too low. Bearing may be stiff after a period of disuse.
- Automatically clears after 5 mins. Please try again.

"Connection failure"

- Loose connection between Alde control panel and boiler.
- Unplug cable at the control panel and boiler, then carefully plug back in.
- Check there is slack on the cable at the control panel, but not excessive weight from free-hanging/unmanaged cable.

"Window open"

- Optional window sensor has triggered, gas heating is suspended. Automatically clears and gas heating resumes when window is closed.

"Connection fail ext"

- Break in communications between Alde control panel and daisy-chained third party control panel.
- Check the cable between the Alde control panel and third party control panel.

"Low battery"

- 12v supply to boiler has dropped below 10.5v, possibly causing system brownout.
- Automatically clears when 12v supply reaches 11v.

"No match Heater/Panel"

- Control panel is incompatible with boiler PCB.
- Check control panel part number. Control panel 3020-013 is for 3020 A-series boiler, 3020-113 is for 3020 HE-series boiler.

If problems persist, please contact Alde, or your dealer or installer.

For frequently asked questions, or download all instruction manuals, please visit Alde's web site at:

www.alde.co.uk

TRUMA COMBI 2 E UK COMBI 4 E / 6 E Version UK

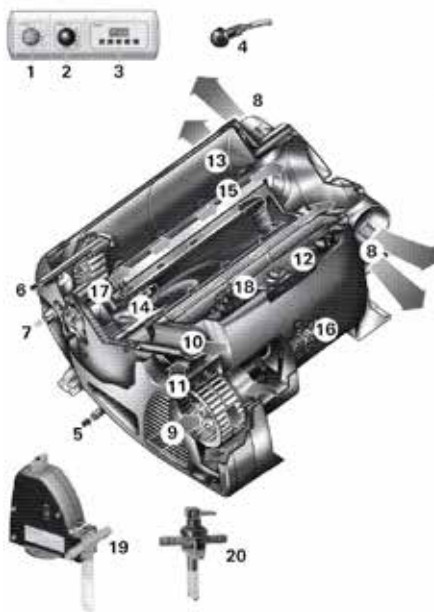

1. Control Panel
2. Power Selector Switch
3. Time Switch ZUCB (Accessories)
4. Room Temperature Sensor
5. Cold Water Connection
6. Hot Water Connection
7. Gas Connection
8. Hot Air Outlets
9. Recirculated Air Intake
10. Waste Gas Discharge
11. Combustion Air Infeed
12. Electronic Control Unit
13. Water Container (10 litres)
14. Burner
15. Heat Exchanger
16. Power Electronics
17. Heating Elements 230V
18. Overheating Switch 230c
(Not supplied on Pursuit Range)
19. FrostControl (Safety/Drain Valve),
20. Safety Drain Valve

Function Description

The liquid gas heater Combi E is a warm-air heater with integrated hot water boiler (10 litres volume). The burner operates fan supported, which ensures trouble-free function even when on the move. The unit also has heating elements for electrical operation. In winter operation the heater can be used to heat the room and simultaneously warm water. If only warm water is required, select summer operation.

Winter Operation

In winter operation, the unit automatically selects the required power setting according to the temperature difference between the temperature set on the control panel and the current room temperature. When the boiler is filled the water is automatically heated as well. The water temperature depends on the selected operational mode and the heater output.

All 3 energy selection options can be used for winter deployment.

With gas operation the unit automatically selects the output level that is required.

Depending on the fuse protection at the camping site, power of 900w (3.9A) or 1800w (7.8A) can be manually selected for electrical operation.

If more output is required (e.g. heating up or low outside temperatures) gas or mixed operation should be selected so that enough heating power is always available.

With mixed operation, 230v electrical operation is preferred if the power requirement is low (e.g. for maintaining the room temperature). The gas burner is not enabled until the power requirement is higher and is the first to switch off during heat-up operations.

Summer Operation (boiler operation only)

Gas operation or 230v electrical operation is used for hot water preparation. The water temperature can be set at 40°C or 60°C.

- With gas operation the water is heated at the lowest burner setting. Once the water temperature is reached the burner switches off.
- Depending on the fuse protection at the camping site, power of 900W (3.9 A) or 1800W (7.8A) can be manually selected for electrical operation.



Mixed operation is not possible. With this setting the unit automatically selects electrical operation. The gas burner is not enabled.



Repairs may only be carried out by an expert.

Operating Instructions

Always observe the operating instructions and "Important operating notes" prior to starting!

The vehicle owner is responsible for the correct operation of the appliance.

The installer or vehicle owner must apply the yellow sticker with warning information, which is enclosed with the appliance, to a place in the vehicle where it is clearly visible to all users (e.g. on the wardrobe door) Ask Truma to send you stickers if necessary.

Before using for the first time it is essential to flush the entire water supply system through with clean water. If the heater is not being used, always drain the water contents if there is a risk of frost. There shall be no claims under guarantee for damage caused by frost.

Materials in the device which come into contact with water are suitable for use with drinking water (see manufacturer declaration: www.truma.com - Manufacturer Declaration).

Room Thermostat

To measure the room temperature, an external room temperature sensor (s) is located in the vehicle by the control panel.



S = Room temperature sensor

The thermostat setting on the control panel (1-5) must be determined individually depending on the heating requirement and the type of vehicle. For an average room temperature of about 23 degrees we recommend a thermostat setting of about 4.

Safety/Drain Valve (operational)

Filling the water heater

Check the safety/drain valve in the cold water intake is closed. Lever should be in horizontal position, position e.

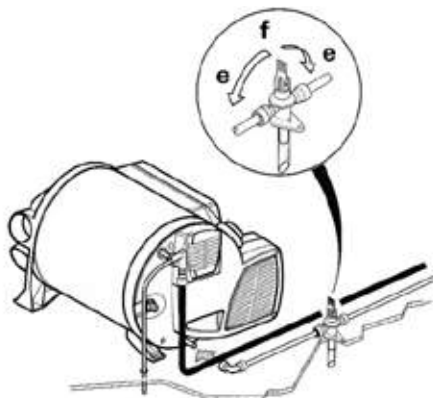

e = Lever position "closed"
f = Lever position "drain"

Open hot tap in bathroom or kitchen with pre-selecting mixing taps or single-lever fittings set to "hot".

Switch on power for water pump (main switch or pump switch).

Leave tap open to let air escape while the water heater is filling. The heater is filled when water flows out of the tap.

Residues of frozen water can prevent filling if there is a frost. The water heater can be defrosted by switching on the heater for a short period. Frozen pipes can be defrosted by heating the room.

Draining the Water Heater



If the caravan is not used during the winter the boiler must be drained
Disconnect power for water pump.

Open hot water taps in bathroom and kitchen.

Open safety/drain valve: Lower the lever in vertical position; position f.

The water heater is now drained directly to the outside via the safety/drain valve. Check

that the water contents have been completely drained (10 litres).

Closing the Drain Valve

Check if the rotary switch is set to "Operation", meaning that it is parallel to the water connection and engaged.

Close the drain valve by activating the push button. The push button must engage in position.

Only when the temperature around the drain valve is over around 7°C can it be closed manually with the press button and the boiler filled.

Truma supplies a heating element (part number; 70070-01) as an accessory, which is inserted into the Frost Control and fixed in place with a retaining bracket. This heating element heats the Frost Control to approx. 10°C when the Combi is switched on. This means that the boiler can be filled after a shorter time, irrespective of the temperature in the installation compartment.

Manual Operation of the Drain Valve

Turn the rotary switch by 180 degrees until it engages, whereby the push button moves out. The water in the boiler drains out through the drainage muff.



The Frost Control drainage muff must be free of contamination (slush, ice, leaves etc) at all times so the water can drain out easily. There shall be no claims under guarantee for damage caused by frost.

Filling the Water Heater

Check if the rotary switch for the drain valve is set to "Operation" meaning that it is parallel to the water connection and engaged.

Close the drain valve by pushing the button until it engages.

When the temperature at Frost control is below about 7°C, first switch on the heater to warm the installation compartment and Frost control. After several minutes, when the temperature at Frost control is above 7°C the drain valve can be closed.

Switch on power for water pump (main or

pump switch).

Open hot water taps in kitchen and bathroom, (set preselecting mixing taps or single-lever fittings to "hot"). Leave the fittings open for as long as it takes for the boiler to displace the air and fill up and the water to flow without interruption.



If just the cold water system is being operated without using the water heater, the heater tank also fills up with water. To avoid frost damage the boiler must be drained through the drain valve even if it was not operated.



When connecting to a central water supply (rural or city mains) a pressure reduction valve must always be installed to prevent above 2.8 bar from developing in the water heater.

Draining the Water Heater

Switch off power to water pump (main or pump switch).

Open hot water taps in kitchen and bathroom.

In order to check the water that is flowing out, place an appropriate container (capacity 10 litres) beneath the drain valve (Frost Control) drainage muff.

Turn the rotary switch on the drain valve by 180°C until it engages, whereby the push button moves out and the drain valve opens.



Check whether all of the water in the boiler (10 litres) has been drained into the container via the drain valve.

There shall be no claims under guarantee for damage caused by frost.

Methods of Operation

Heating is possible without restrictions with gas, electrical and mixed operation, with or without water.



Check to make sure the cowl is unobstructed. Be sure to remove any covers that may be present.

Turn on gas cylinder and open quick-acting valve in the gas supply line.

Check whether the power supply fuse protection on the camp site is adequate for the 900W (3.9A) or 1800W (7.8A) that have been selected using the power selector switch.

Summer Operation (boiler operation only)

Select gas or electrical operation using the power selector switch. Illumination of the yellow LED on the power selector switch indicates that the unit is operating on 230v.

Mixed operation (gas and electrical) is not possible in summer mode. With this setting the unit automatically selects electrical operation with a preselected power setting of 900W or 1800W.

Move the rotary switch on the control panel to 40°C or 60°C. The green and yellow LEDs light up.

When the selected water temperature is reached (40°C or 60°C) the heater shuts off and they yellow LED goes off.

Winter Operation

Heating with water temperature monitoring.

Select gas, electrical or mixed operation using the power switch. Illumination of the yellow LED on the power selector switch indicates that the unit is operating with 230v.

Move rotary switch on control panel to operating position.

Set the rotary switch to the desired thermostat setting (1-5). The green LED for operation is lit and simultaneously indicates the position of the selected room temperature. The yellow LED indicates the water's heat-up phase.

The device automatically selects the required power setting in accordance with the temperature difference between the temperature selected on the control panel and the current room temperature. When the room temperature selected on the control panel is reached, the heater switches back to the smallest setting and heats the water to 60°C. Once the water temperature is reached the heater switches off and the yellow LED goes out.

Heating without water temperature monitoring.

Select gas, electrical or mixed operation using the power switch. Illumination of the yellow LED on the power selector switch indicates that the unit is operating with 230v.

Move rotary switch on control panel to operating position.

Turn the rotary switch to the desired thermostat setting (1-5). The green LED for operation is lit and simultaneously indicates the position of the selected room temperature. The yellow (LED) will be lit only when the water temperature is below 5°C.

The device automatically selects the required power setting in accordance with the temperature difference between the temperature selected on the control panel and the current room temperature. Once the room temperature selected on the control panel has been reached, the heater switches off. The warm air fan continues to run at slow speed until the outgoing air temperature (on the unit) has fallen to 40°C or less.

If the boiler is filled, the water will automatically be heated at the same time. The water temperature is then dependent on the heating output being given off and the duration of heating required to reach the desired room temperature.

Heating with drained water system.

Select gas or electrical operation using the power selector switch. Illumination of the yellow LED on the power selector switch indicates that the unit is operating with 230v. Move rotary switch on control panel to operating position.

Turn the rotary switch to the desired thermostat setting (1-5). The green LED for operation is lit and simultaneously indicates the position of the selected room temperature. The yellow LED will be lit only when the temperature of the unit is below 5°C.

Depending on the operating mode, the unit will automatically select the required power level according to the temperature difference between the setting on the control panel and the current room temperature. Once the room

temperature selected on the control panel has been reached, the heater switches off. The warm air fan continues to run at slow speed until the outgoing air temperature (on the unit) has fallen to 40°C or less.

Switching off



Switch off heater at control panel using rotary switch. The green LED goes off.



If the green LED blinks after switching off, then the unit's after-running is active in order to reduce the unit's temperature. This will end after a few minutes and the green LED will go off.

Always drain water contents if there is a risk of frost.

If the appliance is not to be used for a prolonged period, close the quick-acting valve in the gas supply line and turn off the gas cylinder.

Fault Gas Operation

If a fault occurs during gas operation the red LED on the control panel illuminates.

Please consult the troubleshooting list for possible causes. This can be found on pages 78 and 79.

A reset (fault reset) is carried out by switching off, waiting until all LEDs on the control panel have stopped flashing and then switching the heater on again.



If a window to which a window switch has been fitted is opened, the heater stops operating and the red LED flashes. The heater continues operating when the window is closed.

Electrical Operation

In the event of a malfunction on the electrical mode, the yellow LED on the power selector switch goes off and the red LED on the control panel flashes with 5Hz.

Possible causes can be found in the troubleshooting list, pages 78&79.



If the 230v power supply is interrupted for just a brief period of approximately 1 second during operation, the heater will subsequently resume as normal.

Mixed Mode

Malfunction in the power supply 230v.

The yellow LED on the power selector switch goes off and the red LED on the control panel flashes with 5Hz.

If in mixed mode the 230v power supply is interrupted the heater automatically switches to gas mode. As soon as the 230v power supply is available again the heater automatically returns to the mixed mode.

Possible causes can be found in the troubleshooting list, pages 78&79.

Fault in the combustion process.

The yellow LED on the power selector switch shines and the red LED on the control panel also shines.

If the flame goes out in mixed mode (e.g. empty gas cylinder or closed exhaust outlet), the heater automatically switches to electrical mode. If the heater runs in mixed mode again, the cause for the fault needs to be remedied and the control panel needs to be switched off and on again.

Possible causes can be found in the troubleshooting list, pages 78&79.

Maintenance

Only original Truma parts may be used for maintenance and repair work.

The device must be de-scaled on a regular basis (at least twice a year).

We recommend the Truma system care set for cleaning, disinfecting and looking after the boiler. Other products - in particular products containing chlorine - are unsuitable.

The effectiveness of the use of chemicals to combat micro-organisms in the unit can be increased by heating the water in the boiler to 70°C. at regular intervals.

Move power selector switch to gas operation to do this.



Move the rotary switch on the control panel to 60°C. The green and yellow LEDs light up.

Once the water in the boiler has reached temperature of 60°C, the burner will switch off and the yellow LED will go out. The unit must stay switched on for at least 30 minutes and no warm water may be removed. The residual heat in the heat exchanger will heat the water up to 70°C.

Fuse 12v

The fuse is in the electronics beneath the connection cover.

Replace the unit's fuse only with an identical fuse.

Device fuse 10 A - low - (T 10 A)

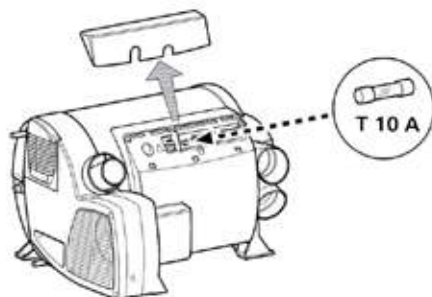

Fuse 230v

The fuse and the power supply lines must only be replaced by an expert.

The unit must be disconnected from the mains (all poles) before opening the electronic housing lid.

The fuse is in the power electronics (16) beneath the electronic housing lid.

This fine fuse must always be replaced with a fuse of the same type: 10 A, slow, interrupting capacity H.

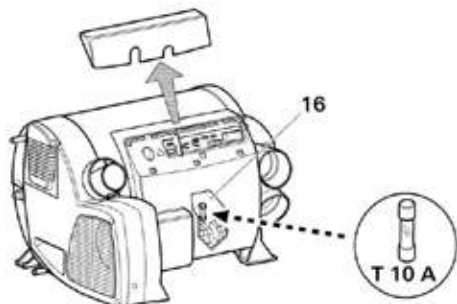

Overheating Protection 230v.

The 230v heating facility has a mechanical overheating switch. If the 12v power supply is interrupted during operation or during the after-run period, for example, the temperature within the unit could activate the overheating protection.

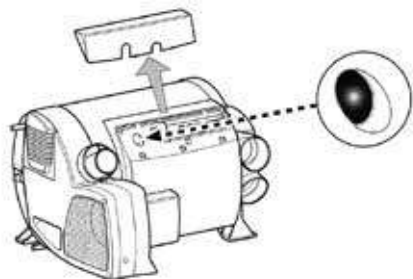

To reset the overheating protection, allow heater to cool, remove connection cover and press red reset button.

Fault	Cause	Remedy
No LED is shining, the device is switched on and is supplied with operating current.	Automatic restart is blocked, e.g. after a power failure.	Reset (fault reset) by switching off, waiting 5 seconds and then switching on again.
After switching (winter and summer operation) none of the LEDs are lit.	No operating voltage. Device fuse or vehicle fuse defective.	Check 12v battery voltage, charge if necessary. Check all electrical plug connections. Check the unit or vehicle fuse and replace if necessary (see fuses).
The green LED comes on when the unit is switched on but the heater does not operate.	The temperature setting on the control panel is lower than the room temperature.	Select higher room temperature at the control panel.
After switching on the heating system, the green LED shines and		
a. The red LED flashes with 5Hz.	Open window above cowl (window switch). Under-voltage. Battery voltage is too low <10.0v. No 230v operating voltage. 230v fuse defective. Overheating protection has activated.	Close window. Charge battery. If necessary replace old battery. Re-establish 230v operational voltage. Replace 230v fuse. Reset overheating protection. Allow heater to cool, remove connection cover and press reset button.
b. The red LED flashes with 1Hz.	Threatening under-voltage. Battery voltage is too low < 10.4v.	Charge battery.
c. The red and the yellow LEDs flash alternately with 1Hz.	There is a threat of under-voltage when heating up the water. Battery voltage is too low < 10.4v.	Charge battery.
After the heater is switched on, the green LED is lit and the red LED blinks.	Electronics are defective.	Please contact the Truma Service Centre.
Approximately 30 seconds after the heater is switched on, the red LED is lit.	Gas cylinder or quick-closure valve in the gas line is closed. Combustion air in-feed or exhaust outlet is sealed.	Check gas supply and open valves. Inspect openings for contamination (slush, ice, leaves, etc) and remove contamination if necessary.

<p>After operating for a longer period of time, the heater switches to failure.</p>	<p>Summer operation with empty water tank.</p> <p>Hot-air outlets blocked. Recirculated air intake blocked. Gas pressure regulator iced up.</p> <p>Butane content in the gas cylinder too high.</p>	<p>Switch device off and allow to cool. Fill boiler with water.</p> <p>Check individual outlet apertures.</p> <p>Remove blockage from recirculated air intake.</p> <p>Use regulator heating (EisEx).</p> <p>Use propane (at temperatures below 10°C in particular, butane is unsuitable for heating purposes).</p>
---	---	--

Truma CP Plus Digital Control Panel

Operating Instructions

Safety instructions

- The device may only be operated if it is in perfect working order.
- Arrange for malfunctions to be rectified immediately. Only rectify malfunctions yourself if the remedy is outlined in the troubleshooting information in these Operating Instructions. These can be found on page 86.
- Do not repair or modify the device.
- Only allow the manufacturer or its customer service to repair a faulty device.

 If the power supply to the system is interrupted for longer than 20 minutes, the time and date need to be entered again.

If the Truma Combi heater is connected to the control panel Truma CP Plus, the heater can no longer be switched via a ZUCB timer.

Intended Use

The control panel Truma CP Plus serves to control and monitor a Combi heater and/ or a Truma air conditioning unit. The device is designed for installation in caravans and motor-caravans.

Display and control elements

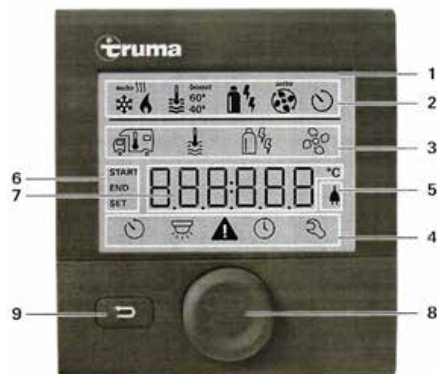

1. Display
2. Status line
3. Menu line (above)
4. Menu line (below)
5. Display of mains voltage 230v (shore power)
6. Display timer
7. Settings/values

8. Control knob/push button

9. Back button

The control knob/push button (8) is used to select menus in lines 3+4 and configure the settings. These are shown via a display (1) with a lighted background. Pressing the Back button (9) takes the user back out of the menu again.

Control knob/push button

The control knob/push button (8) is used to select and change set values and parameters: these can be saved by clicking the control knob/push button. Selected menu items will flash.



Turn to the right (+)
Menu is paged from left to right.
Increase values.

Turn to the left (-)
Menu is paged from right to left.
Reduce values.



Clicking
Accept (save) a selected value.
Select a menu item or a change to the setting level.



Press (3 seconds)
Main switch function ON/OFF

Back Button

Pressing the Back button (9) takes the user back out of the menu again and discards the settings. This means that the previous values are retained.

Functions

The functions in the menu lines 3 & 4 of the control panel can be selected in any sequence. The operating parameters are shown in the status line (2) or the displays 5 and 6.

Start/standby screen

After connecting the control panel to the power supply, a start screen is shown after a few seconds.



If no entry is made within a few minutes, the standby screen is automatically shown again. The display shows the time and correct room temperature alternately.

Switch on/return to setting level

- Press the control knob/push button for longer than 3 seconds or the back button. The display shows the setting level. The first symbol flashes.



Previously set values/operating parameters become active again after the system is switched on.

Switch off

- Press the control knob/push button for longer than 3 seconds.

Change the room temperature

- Use the control knob/push button to select the symbol in menu line (3).
- Click to change to the setting level.
- Depending on the connected device, use the control knob/push button to select between the heater or air conditioning unit.
- Use the control knob/push button to select the required temperature.
- Click the control knob/push button to confirm the value.

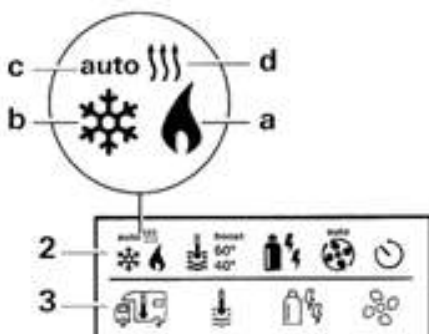

Heater

Settable temperature range 5°C-30°C (1°C steps)

a = heater * - Heater is switched on.

* This symbol will flash until the required room temperature is reached.

Change the warm water level

- Use the control knob/push button to select the symbol in menu line (3).
- Click to change to the setting level.
- Use the control knob/push button to select the required level.
- Click the control knob/push button to confirm the value.

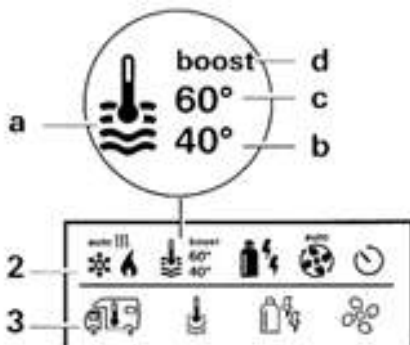

a = Boiler *

- Warm water boiler is switched on.

b = 40°

- Warm water temperature 40°C.

c = 60°C

- Warm water temperature 60°C.

d = boost *

- Targeted, fast heating of the content of the boiler (boiler priority). The water temperature is kept at the higher level (around 62°C) - Not Combi Diesel.

Once the water temperature is reached, the room is heated again.

* This symbol will flash until the required water temperature is reached.

Select power type

- Use the control knob/push button to select the symbol in menu line (3).
- Click to change to the setting level.
- Use the control knob/push button to select the required power type.

Click the control knob/push button to confirm the value.

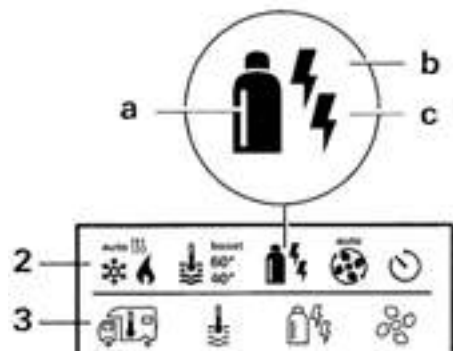

Symbol	Operating mode	Power type
a	Gas/Diesel	Gas/Diesel
b	EL 1	Electro
b + c	EL 2	Electro
a + b	Mix 1 *	Gas/Diesel+ Electro
a + b + c	Mix 2 *	Gas/Diesel+ Electro

* Mixed mode

Special aspects in the mixed mode

Interruption of the power supply 230v

Combi Gas: The heater automatically switches to the gas mode. As soon as the 230v power supply is connected, the heater automatically switches back to the mixed mode.

Malfunction in the combustion process (e.g. lack of fuel)

Combi Gas The heater automatically switches to the electro mode. If the heater should operate in the mixed mode again, the cause of the malfunction needs to be rectified. Switch the heater off and on again on the control panel.

Select fan level

When the heater/air conditioning unit is concerned.

- Use the control knob/push button to select the symbol in menu line (3).
- Click to change to the setting level.
- Use the control knob/push button to select the required fan level.
- Click the control knob/push button to confirm the value.

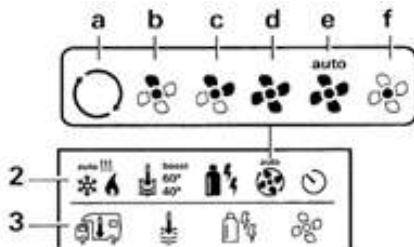

Heater Combi

Symbol	Operating Mode	Description
-	Off	Fan is switched off
a	Vent	Circulating air: if no device is in operation 9 speed levels can be selected
b	Eco	Low fan level
c	Mild	High fan level
d	High	Fast heating of the room. Available, if the difference between selected and current room temperature is >10°C

Set timer

- Use the control knob/push button to select the symbol in Menu line (4)
- Click to change to the setting level.

If the timer is activated (ON), the timer in the menu is shown as deactivated (OFF).

Enter start time

- Use the control knob/push button to set the hours, then the minutes.

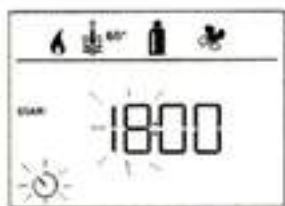

Enter end time point

- Use the control knob/push button to set the hours, then the minutes.



- i** If the start time has passed when entered, the operating parameters are only taken into consideration when the next start/end times are reached. Until then, the operating parameters set outside the timer remain valid.

Set the room temperature

- Click to change to the setting level.
- Use the control knob/push button to select the required room temperature.
- Click the control knob/push button to confirm the value.



Set the warm water level

- Click to change to the setting level.
- Use the control knob/push button to select the required warm water level.
- Click the control knob/push button to confirm the value.

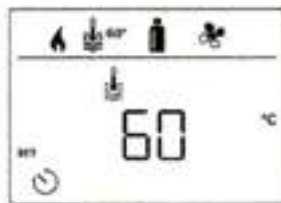

Select power type

- Click to change to the setting level.
- Use the control knob/push button to select the power type.
- Click the control knob/push button to confirm the value.



Select fan level

- Click to change to the setting level.
- Use the control knob/push button to select the required fan level.
- Click the control knob/push button to confirm the value.

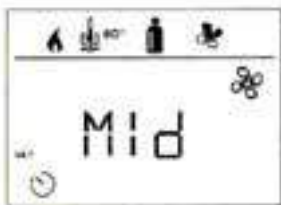

Activate the timer (ON)

- Click to change to the setting level.
- Use the control knob/push button to activate the timer (ON).
- Click the control knob/push button to confirm the value.



The timer remains active, even for several days, until it is deactivated (OFF).

Deactivate the timer (OFF)

- Click to change to the setting level.
- Use the control knob/push button to deactivate the timer (OFF).
- Click the control knob/push button to confirm the value.



Set time

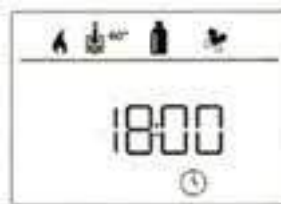

- The hour display flashes.
- Use the control knob/push button to set the (24h mode).
- After clicking the control knob/push button again, the minute display will flash.
- Use the control knob/push button to set the minutes.
- Click the control knob/push button to confirm the value.

Service Menu

Query the index status of a connected device



Change the background lighting of the control panel

There are 5 background lighting levels to choose from.

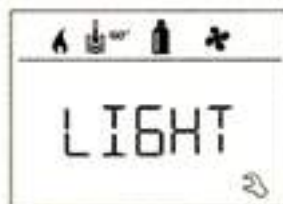

Change language

Select the required language from those available (e.g. English, German, French, Italian).



Display mains voltage 230v

The symbol indicates that 230 V mains voltage (shore power) is available.

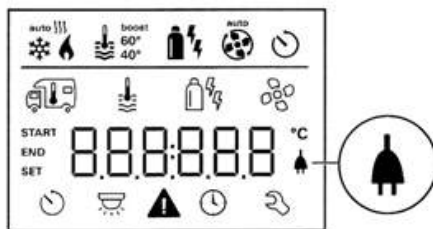

In the event of a warning, a warning symbol appears to indicate that an

operating parameter has reached an undefined status. In this case, the affected device continues to run. As soon as the operating parameter returns to set range, this symbol will turn off automatically.



Read out the warning code

- Use the control knob/push button to select the symbol.
- Click the control knob/push button. The current warning code is shown. The cause of the warning can be identified and rectified via the error list.

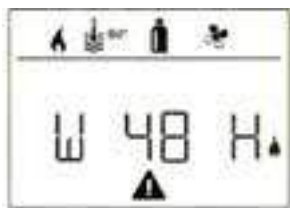

Cause rectified/return to setting level

- Click the control knob/push button.

Cause not rectified/return to setting level

- Press the back button.

In this case, the warning is not acknowledged on the control panel and the warning symbol remains. The control panel remains in the warning status. Devices connected to the control panel can be operated.

Malfunctions

In the case of a malfunction, the control panel immediately jumps to the menu level "malfunction" and shows the error code of the malfunction.

Cause remedied/return to setting level

- Click the control knob/push button.
- The respective device is restarted.

Troubleshooting instructions (Combi Gas heater)
If the cause is not remedied, the malfunction will occur again and the control panel will jump again to the menu level "malfunction"

Cause not remedied/return to setting level

- Press the back button.



In this case, the malfunction is not acknowledged in the control panel and the warning symbol remains on. The device remains in the malfunction status. Other devices connected to the control panel can be operated.

Troubleshooting instructions (Combi Gas Heater)

Error Code	Cause	Remedy
#17	Summer mode with empty water container	Switch off device and allow to cool. Fill boiler with water
	Warm air outlet blocked	Check each of the outlet openings
	Circulated air intake blocked	Remove the blockage from the circulated air intake
#18	Gas pressure regulator frozen	Use the regulator heating
	Too much butane in the gas cylinder	Use propane (butane is unsuitable for heating especially at temperatures below 10°C.)
#21	Room temperature sensor or cable faulty	Please contact Truma Customer Services
#24	Potential under-voltage battery voltage too low <10.4v	Charge the leisure battery
#29	Heating element for Frost Control has a short circuit:	Disconnect the heating element plug on the electronic control unit. Replace heating element.
#41	Electronics are blocked:	Please contact Truma Customer Services
#43	Over-voltage: 16.4V	Check the battery voltage and voltage sources e.g. charger
#44	Under-voltage battery voltage too low	Charge battery. Replace any old batteries
#45	No 230v operating Voltage	Reconnect the operating voltage 230v
	Faulty 230v Fuse	Replace 230v fuse
	Overheating protection has triggered	Reset the overheating protection. Allow the heating to cool down, remove the connection cover and press the reset button
#112	Gas cylinder or quick-acting valve in the gas line is closed	Check the gas supply and open the valves
#212	Combustion air intake or exhaust outlet is closed	Check the openings for soiling (snow, leaves, ice etc) and remove
#255	No panel connection between the heater and the Control panel	Please contact Truma Customer Services
	Control panel cable faulty	Please contact Truma Customer Services

LAMILUX COMPOSITES

*Fibre-reinforced composites -
the high-tech material for roofs, walls and floors*



Long lasting, very light and strong, especially resistant to damage from hail and minor impacts, whilst also being resistant against corrosion. Fibre reinforced composites are the ideal facing choice for the sandwich panel

element used in the construction of all areas of caravans and RVs, whether the external or internal walls, floor or roof - fibre reinforced composites from Lamilux are technical and visual highlights.



All tests certified in compliance
with TÜV Süd quality



TUV SUD certified quality

LAMILUX COMPOSITES GmbH | Zoltenhof 2 | 66111 Rehau/Germany
Tel: +49 (0) 92 83 696 0 | Fax: +49 (0) 92 83 696 99 0 | E-mail: Information@lamilux.de

SALES MANAGER IN GREAT BRITAIN: GIP Marketing Ltd. | Nick Gussak
Tel: +44 (0) 788 088 0481 | Email: nick@gipmarketing.com



www.lamilux.com

21. EXTERIOR FEATURES

GRP

GRP components need to be washed, waxed and cared for like a car. Chemicals and dirt can collect during storage, and the outer surface called a gel coat can be stained or marked when chemicals combine with rain or dew. Most stains or marks can be removed with mild dish-washing detergent, but more stubborn marks may require a rubbing compound. To help keep your GRP components looking almost like new, it is wise to wash the parts monthly (or more frequently) using mild dish-washing detergent, but avoid using strong alkaline (e.g. tri-sodium phosphate) or acidic cleaners or abrasives. Waxing the components once or twice a year with a good grade paste wax will help to maintain the colour and finish.

ROOFLIGHTS

HEKI Rooflights

Operating, Safety and Care Instructions HEKI

1. Opening in the tilt setting

a) Press the locking buttons at both catches on the glass and turn inwards through approx. 90°.

b) Grasp the bar in the middle, unclasp from the anchoring fasteners, swivel the bar down and push the glass dome upwards. (Glass dome is assisted after approx. 150mm by the two pneumatic springs.)

c) Swivel the bar towards the glass dome and clip into position.

To close the HEKI, perform steps (a-c) in reverse order.

2. Opening in the intermediate setting

a) Open both catches on the glass.

b) Grasp the bar in the middle, unclasp from the anchoring fasteners, swivel down and push the glass dome upwards. (Glass dome opens automatically after approx. 150mm through the two pneumatic springs.)

c) Open both fasteners, and swivel the bar towards the intermediate setting and pull the glass dome down until the bar rests in the hold.

d) Secure the bar with the two fasteners.

To close HEKI, perform steps (a-d) in reverse order.

3. Opening in permanent ventilation setting

a) Open both catches on the glass.

b) Push glass dome up approx. 2cm with both hands on the two catches and turn the catches to fix them in the ventilation setting.

To close HEKI, perform steps (a-b) in reverse order.

4. Closing the blind

a) To close the blind, grasp the end rod (without grip) in the recess and engage in the opposite end rod (with grip).

Caution! When the sun is shining brightly, the blind may only be closed 2/3 and the glass dome must be fixed in the "permanent ventilation setting".

b) You can move both joined end rods to adjust the blind to the required position (black out/

fly screen/sun shade).

5. Opening the blind.

- a) Move the blind right out to the side (end rod with grip).
- b) Holding the recess with one hand, press the rocker with the other hand and guide the blind back into position.

Safety instructions:

- Do not stand on the acrylic glass.
- Close HEKI completely before moving the vehicle.
- Close HEKI when leaving the vehicle.
- Please consult your dealer when any defects or problems occur.
- Remove snow/ice or other dirt from the roof before opening HEKI.
- Do not open in strong winds or heavy rain.

Care instructions:

- Please clean the acrylic panes with the Seitz Acrylic Cleaner.
- Stains and light scratches on the acrylic pane can be removed using the Seitz Acrylic Polish and Seitz special polishing cloth.

- Only use water and mild soap suds to clean the blinds.
- Failure to comply with these instructions makes the guarantee null and void.

MPK Rooflight

The MPK roof light is situated in the bathroom of your caravan over the shower compartment. It is fitted with a fly screen for your comfort. The fly screen is hinged, allowing you access to the handles that enable you to raise the rooflight's dome for ventilation.

To raise the dome pinch the black parts of the handle against the other half on both sides and push upwards. Both sides can be raised or just one, depending on your preference.



01234 848000

www.cgi-visual.com

customise@cgi-visual.com

22. COOKING EQUIPMENT

The Caprice Cooker- used in Unicorn and Pegasus models



Never use the cooker as a space heater.



Before using the appliance please ensure that you are aware of the following:

- Appliance and accessible parts become hot during use.
- Avoid touching heating elements.
- Children less than 8 years of age shall be kept away unless continuously supervised.
- This appliance can be used by children aged 8 years and above, persons with reduced physical, sensory or mental capabilities and/or lack of experience and knowledge only if they have been given supervision or instruction concerning use of the appliance in a safe way and understand the hazards involved.
- Children shall not play with the appliance.
- Cleaning and user maintenance shall not be made by children without supervision.
- Unattended cooking on a hob with fat or oil can be dangerous and may result in fire.
- Never extinguish a fire with water; switch off the appliance and cover flame with lid or fire blanket.
- Danger of fire: Do not store items on the cooking surface.
- Do not use harsh abrasive cleaners or sharp metal scrapers to clean the oven door glass since they can scratch the surface, which may result in shattering of the glass.
- Never use a steam cleaner to clean the appliance.

Operation

The burners on this appliance have fixed aeration and no adjustment is required. The burners should flame as follows:

Propane: The flames should burn quietly with a blue/green colour with no sign of yellow tips.

Butane: Normally, on initial lighting, a small amount of yellow tipping will occur. This then increases slightly as the burner heats up.

Using the Hotplate Gas Burners



Ensure that the glass lid is open before turning on the burners.

Glass lids may shatter when heated. Turn off all burners before shutting the lid.

The glass lid has a tendency to snap shut towards the lowered position. Make sure all fingers are removed from the appliance when closing the lid.

Remove all spillages from the glass lid before opening.

Children should be supervised to ensure that they do not play with the appliance.

1. Ensure gas cylinder/supply is connected and turned on. In the event of a gas smell turn off at gas cylinder/mains and contact supplier.
 2. Flame supervision: each burner is controlled individually and is monitored by a thermocouple probe. In the event of the burner flames being accidentally extinguished, turn off the burner control and do not attempt to re-ignite the burner for at least one minute.
 3. To light: push in the control knob and turn to full rate-large flame . Light the hob by depressing the ignition button, which is located on the fascia. It is necessary to hold the knob depressed after the burner has ignited for approximately 10-15 seconds, to allow the thermocouple probe to reach temperature, before releasing the knob. Should the flame go out when the knob is released, the procedure should be repeated holding the knob depressed for slightly longer.
 4. If the burner has not lit within 15 seconds the control knob should be released and the burner left for at least 1 minute before a further attempt to ignite the burner.
 5. For simmering, turn the knob further anti-clockwise to the low rate position.
 6. To turn off: turn the control knob until the line on the control knob is aligned with the dot on the control panel. Always make sure the control knob is in the off position when you have finished using the hotplate burners.
- Each burner will support pans from Ø10 to Ø22cm; care should be taken not to overload the appliance as performance may be reduced.

- The following pan sizes are the maximum we recommend:
- Electric hotplate: - Ø180mm (Dual Fuel only)
- Auxiliary burner: Ø200mm
- Semi-rapid burner: 2x Ø200mm or 1x Ø220mm with 1x Ø180mm
- When using small pans the flames should not spread beyond the base of the pan as this will reduce the efficiency of the burner.
- Avoid old or misshapen pans as these may cause instability.
- The lid must be opened fully prior to using the hotplate burners.

Using the Electric Hotplate (Dual Fuel Models)

Ensure power is switched on. The hotplate control is numbered from 1 to 6. To turn it on, rotate the knob either clockwise or anti-clockwise to the required position. Position 1 is the coolest setting. To turn off, rotate the knob until the line or pointer on the knob lines up with the zero on the control panel.

The hotplate is a sealed construction and transfers heat through conduction. For maximum efficiency a correctly sized pan with a flat heavy gauge base should be used. Pan size should be the same or slightly larger (up to 1" / 2.5cm oversize).

Before using your hotplate for the first time, we recommend that you prime and season it.

To prime the hotplate

Switch on the hotplate for a short period, without a pan, to harden and burn off the coating. Use a medium to high setting for 3-5 minutes. A non-toxic smoke may occur during this process. Allow it to cool, then season.

To season the hotplate

First heat the hotplate for 30 seconds on a medium setting, and then switch off. Pour a minimal amount of unsalted vegetable oil onto a clean dry cloth or paper towel, and apply a thin coat of oil to the hotplate surface. Wipe off any excess oil, then heat the hotplate on a medium setting for 1 minute. Occasional seasoning will help to maintain the hotplate's appearance.

Using the Grill

1. Ensure gas cylinder/supply is connected and turned on. In the event of a gas smell turn off at gas cylinder/mains and contact supplier.
2. To light: open door, push in the control knob and turn to full rate-large flame . Hold a lighted match or taper to the burner, push the control knob in and hold. The burner should ignite and the control knob should be held in for 10-15 seconds before release. If the burner goes out, repeat procedure holding control knob for slightly longer.
3. For models fitted with spark ignition the procedure is similar except that the burner can be ignited by depressing the ignition button, which is located on the fascia. Ignition must be carried out with the door open, and if the burner has not lit within 15 seconds the control knob should be released and the grill left for at least 1 minute before a further attempt to ignite the burner.
4. Note: the grill must only be used with the door open.
5. On first use of the grill, it should be heated for about 20 minutes to eliminate any residual factory lubricants that might impart unpleasant smells to the food being cooked. A non-toxic smoke may occur when using for the first time so open any windows and turn on mechanical ventilators to help remove the smoke.
6. Although the grill does heat up quickly, a few minutes preheat is recommended.
7. Flame Failure Device (FFD): the grill burner is fitted with a flame-sensing probe, which will automatically cut off the gas supply in the event of the flame going out. In the event of the burner flames being accidentally extinguished, turn off the burner control and do not attempt to re-ignite the burner for at least 1 minute. It is normal for the flames on this burner to develop yellow tips as it heats up.
 - A reversible grill pan trivet enables the correct grilling height to be achieved.
 - Fast toasting
 - Position trivet high
 - Grilling sausages
 - Position trivet high
 - Grilling steak/bacon
 - Position trivet high

- Grilling chops etc
 - Position trivet low
 - Slow Grilling
 - Remove the trivet
8. To turn off: turn the control knob until the line on the control knob is aligned with the dot on the control panel. Always make sure the control knob is in the off position when you have finished grilling.



The grill area can get hot when the oven is in use, even if the grill is switched off.

Care should be taken when removing pans from the grill, i.e. by use of oven gloves, and by making use of the removable grill pan handle.



The grill pan supplied is multi-functional, for use in grill or oven. The handle design allows removal or insertion while the pan is in use. Always remove the handle when the pan is in use. The grill **MUST** only be used with the door open.

Using the Oven

1. Ensure gas cylinder/supply is connected and turned on. In the event of a gas smell turn off at gas cylinder/mains and contact supplier.
2. To light: open door, push in the control knob and turn to full rate (240°C). Hold a lighted match or taper to the burner, push the control knob in and hold. The burner should ignite and the control knob should be held in for 10-15 seconds before release. If the burner goes out, repeat procedure holding control knob for slightly longer.
3. For models fitted with spark ignition the procedure is similar except that the burner can be ignited by depressing the ignition button, which is located on the fascia. Ignition must be carried out with the door open, and if the burner has not lit within 15 seconds the control knob should be released and the oven left for at least 1 minute before a further attempt to ignite the burner.
4. Place the oven shelf in the required position and close the door.
5. Set the control knob to required temperature. Although the oven heats

up quickly, it is recommended that a 10-minute preheat be allowed. The oven should be up to full temperature in about 15-20mins.

6. To turn off: turn the control knob until the line on the control knob is aligned with the dot on the control panel.
7. Shelf: the shelf has been designed to allow good circulation at the rear of the oven and is also fitted with a raised bar to prevent trays or dishes making contact with the back of the oven. To remove a shelf, pull forward until it stops, raise at the front and remove. Installation of a shelf is the reverse of this procedure.



Before first use, heat the oven for about 30 minutes at 200°C, to eliminate any residual factory lubricants that might impart unpleasant smells to the meals being cooked. A non-toxic smoke may occur when using for the first time so open any windows and turn on mechanical ventilators to help remove the smoke. Always ensure food is properly cooked prior to serving.

Oven Temperature Control

The temperature in the oven is controlled by a thermostatic gas tap and is variable over the range 130°C to 240°C. Approximate temperatures for the settings on the control knob are shown in the table on page 93. The temperatures indicated refer to the centre of the oven and at any particular setting the oven will be hotter at the top and cooler towards the base.

The variation between top and centre, and centre to bottom is approximately equivalent to one gas mark. Good use can be made of the temperature variation in that several dishes requiring different temperatures may be cooked at the same time. In this way maximum benefit can be obtained from the gas used to heat the oven. Care should be taken not to overload the oven, adequate spacing being used to allow free circulation for heat.

Cooking Guidelines

Although the oven heats up quickly, it is recommended a 10 minute preheat be allowed. The oven should reach full temperature in 15-20 minutes.

When roasting with aluminium tinfoil care

must be taken that the foil does not impair circulation or block the oven flue outlet.

Gas Mark	Temperature (Centre of Oven)			Dish
	265-275°F	130-135°C	Very cool	
¼ - ½			Very cool	Meringues
1	285	140	Cool	Stewed fruit
2	300	150	Cool	Rich fruit cake, rice pudding
3	330	165	Warm	Baked custard, shortbread fingers
4	355	180	Moderate	Victoria sandwich
5	385	195	Fairly hot	Whisked sponges, ginger nuts
6	410	210	Hot	Short crust pastry
7	430	220	Hot	Bread, scones, flaky pastry
8	445	230	Very hot	Puff pastry
9	465	240	Very hot	Quick browning

Do's and Don'ts

DO read the user instructions carefully before using the appliance for the first time.

DO allow the oven to heat before using for the first time, in order to expel any smells before the introduction of food.

DO clean the appliance regularly.

DO remove spills as soon as they occur.

DO always use oven gloves when removing food shelves and trays from the oven.

DO check that controls are in the off position when finished.

DO NOT allow children near the cooker when in use. Turn pan handles away from the front so that they cannot be caught accidentally.

DO NOT allow fats or oils to build up in the oven trays or base.

DO NOT use abrasive cleaners or powders that will scratch the surface of the appliance.

DO NOT under any circumstances use the oven as a space heater.

DO NOT put heavy objects onto open grill and oven doors.

Country Cooking Appliances

Operating Instructions

- Ensure that the gas cylinder is turned on
- In the event of a gas smell turn off at the cylinder and contact your retailer.
- The use of a gas cooking appliance results in the production of heat and moisture in the room in which it is installed. Ensure that the kitchen is well ventilated, keep natural ventilation holes open or install a mechanical ventilation device (mechanical extractor hood).
- Prolonged intensive use of the appliance may call for additional ventilation, for example opening a window, or more effective ventilation, for example increasing the level of mechanical ventilation where present.

The Linear Hob

Hotplate Burners

- Glass lids may shatter when heated. Turn off all burners before shutting the lid.
- The glass lid has a tendency to snap shut towards the lowered position. Make sure that all fingers are removed from the appliance when closing the lid.



Each burner is controlled individually and is monitored by a flame supervision device. In the event of the burner flames being accidentally extinguished, turn off the burner control and do not attempt to re-ignite the burner for at least 1 minute. The respective knob positions are shown.

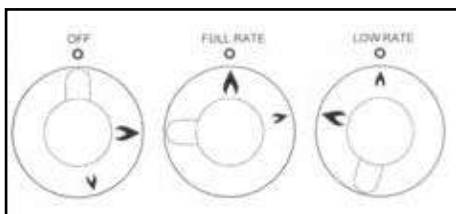

To light the burner, press in and turn the knob anti-clockwise to the full rate position and press the ignition button located on the front of the oven control fascia. It is necessary to hold the knob depressed during ignition and for approximately 15 seconds after the burner has lit to allow the probe to reach temperature. Should the flame go out when the knob is released, the procedure should be repeated holding the knob depressed for slightly longer.

For simmering, turn the knob further anti-clockwise to the low rate position. To turn the burner off, rotate knob fully clockwise until the line on the knob lines up with the dot on the control panel. The burners on this appliance have fixed aeration and no adjustment is required. Depending on the gas being used, the burners should flame as follows:

Propane: The flames should burn quietly with a blue/green colour with no signs of yellow tips.

Butane: Normally, on initial lighting, a small amount of yellow tipping will occur and this slightly increases as the burner heats up.

Care should be taken not to overload the appliance as reduced performance may result.

When using small pans, the flames should not spread beyond the base of the pan as this will reduce the efficiency of the burner.

The Midi Oven and Grill



Accessible parts may be hot when the grill is used! Young children should be kept away.

- The heat deflector below the fascia is positioned in the out position to avoid heat deflection to the knobs during grilling.
- While the grill is operating never adjust the deflector without using hand protection.
- Only use the grill with the door open and

always remove the handle from the pan when in use.

- Ensure gas cylinder/supply is connected and turned on. In the event of a gas smell turn off at the gas cylinder/mains and contact supplier.
- Remove all accessories and packing that may be in the grill including any plastic coating that may be protecting the grill cavity surfaces. Clean the interior before using it for the first time; use soap and water and rinse carefully.
- To light: open the door, push in the control knob and turn to full rate. Press down the ignition button located on the oven fascia. It is necessary to hold the knob for approximately 15 seconds before release. If the burner goes out, repeat the procedure holding the control knob for slightly longer.



Ignition must be carried out with the door open.

- On first use of the grill, it should be heated for about 20 minutes to eliminate any residual factory lubricants that might impart unpleasant smells to the food being cooked. A non-toxic smoke may occur when using for the first time so open any windows and rooflights to remove the smoke.
- Although the grill heats up quickly, it is recommended that a few minutes preheat be allowed.
- Flame Failure Device (FFD): the grill burner is fitted with a flame-sensing probe which will automatically cut off the gas supply in the event of the flame going out. In the event of the burner flames being accidentally extinguished, turn off the burner control and do not attempt to re-ignite the burner for at least 1 minute.
- It is normal for the flames on this burner to develop yellow tips as it heats up, particularly on butane.
- Variation in cooking can be achieved by using the control knob to regulate the heat setting. In addition, the grill pan trivet can be reversed or removed to give a greater choice of grilling height. Always use the highest trivet position for fast toasting.
- To turn off: turn the knob until the line on the control knob is aligned with the dot on the control fascia. Always make sure that the control knob is in the off position when

you have finished grilling.

Oven

- Ensure the gas cylinder is connected and turned on. In the event of a gas smell, turn off the gas at the cylinder and contact your retailer.
- Remove all accessories and packing that may be in the oven and clean the interior before using it for the first time.
- To Light: Open door, push in the control knob and turn to gas mark 9. Depress the ignition button located on the fascia. Ignition must be carried out with the door open, and if the burner has not lit within 15 seconds the control knob should be released and the oven left open for at least 1 minute before a further attempt to ignite the burner.
- Place the oven shelf in the required position and close the door. Set the control knob to approximately gas mark 5 and heat the oven for about 30 minutes to eliminate any residual factory lubricants that might impart unpleasant smells to the meals being cooked.
- Although the oven does heat up quickly, it is recommended a 10-minute preheat be allowed. The oven should reach full temperature in about 15-20 minutes.
- To turn off: turn the control knob until the dot on the control knob is aligned with the dot on the fascia.
- Flame Failure Device: the oven burner is fitted with a flame-sensing probe which will automatically cut off the gas supply in the event of the flame going out.
- Oven shelf: the oven shelf is designed to allow good circulation at the rear of the oven and is fitted with a raised bar to prevent trays or dishes making contact with the back of the oven. Additional shelves are available through your retailer.

Temperature Control

The temperature control in the oven is controlled by a thermostatic gas tap and is variable over the range 130°C to 240°C. Approximate temperatures for the settings on the control knob are shown in the table on page 96. The temperatures indicated refer to the centre of the oven and at any particular setting the oven will be hotter at the top and cooler towards the base. The variation between top and bottom is approximately equivalent to one gas mark. Good use can be made of the

temperature variation in that several dishes requiring different temperatures may be cooked at the same time. In this way maximum benefit can be obtained from the gas used to heat the oven. Care should be taken not to overload the oven, adequate spacing being used to allow free circulation of heat.

Cooking Guidelines

The pan supplied with the appliance is multi-functional, for use with the grill and the oven. Always remove the handle when in use.

Best results will be obtained by using the shelf recommendations from the recipe. It is not necessary to preheat the oven but advisable for a range of dishes. The oven is capable of full temperature in 15-20 minutes.

Most cookery books give details of the shelf positions and gas mark settings for each recipe. When roasting with aluminium tin foil care must be taken that the foil does not impair circulation or block the oven flue outlet.

Gas Mark	Temperature (Centre of Oven)			Dish
	265-275°F	130-135°C		
¼ - ½			Very cool	Meringues
1	285	140	Cool	Stewed fruit
2	300	150	Cool	Rich fruit cake, rice pudding
3	330	165	Warm	Baked custard, shortbread fingers
4	355	180	Moderate	Victoria sandwich
5	385	195	Fairly hot	Whisked sponges, ginger nuts
6	410	210	Hot	Short crust pastry
7	430	220	Hot	Bread, scones, flaky pastry
8	445	230	Very hot	Puff pastry
9	465	240	Very hot	Quick browning

Do's and Don'ts

DO read the user instructions carefully before using the appliance for the first time.

DO allow the oven to heat before using for the first time, in order to expel any smells before the introduction of food.

DO clean the appliance regularly.

DO remove spills as soon as they occur.

DO always use oven gloves when removing food shelves and trays from the oven.

DO check that controls are in the off position when finished.

DO NOT allow children near the cooker when in use. Turn pan handles away from the front so that they cannot be caught accidentally.

DO NOT allow fats or oils to build up in the oven trays or base

DO NOT use abrasive cleaners or powders that will scratch the surfaces of the hotplate and oven

DO NOT allow the door to fall down: lower it by hand.

DO NOT under any circumstances use the oven as a space heater



Ensure that the ceramic ball mixer tap arm is clear from the oven lid before raising it. Failure to do so could accidentally switch on the tap when lifting the glass lid.

Maintenance and Servicing

This appliance needs little maintenance other than cleaning. All parts should be cleaned using warm soapy water. Do not use abrasive cleaners, steel wool or cleansing powders. When cleaning the burner ring it is essential to ensure that the holes do not become blocked. The control knobs are a push fit and can be removed for cleaning. They are

interchangeable without affecting the sense of operation.



All servicing must be carried out by an approved competent person. After every service the appliance must be checked for gas soundness.

Leaks



If a smell of gas becomes apparent, the supply should be turned off at the cylinder IMMEDIATELY.

- Extinguish naked lights including cigarettes and pipes.
- Do not operate electrical switches.
- Open all doors and windows to disperse any gas escape.
- Never check for leaks with a naked flame; leak investigation should be carried out using a leak detector spray.
- Check the gas is not escaping from an unlighted appliance.

Service

The Caprice cooker must be serviced at least once every 12 months. All servicing must be carried out by an approved competent person. Before any service work is started, the appliance should have been left to cool and be disconnected at the mains socket. After each service the appliance must be checked for gas soundness.

For service, please contact your authorised local service agent giving details of the model and serial number on the data badge plus date of purchase.

23. DAEWOO MICROWAVE OVEN



Precautions to avoid possible exposure to excessive microwave energy

- Do not attempt to operate this oven with the door open since open-door operation can result in harmful exposure to microwave energy. It is important not to remove or tamper with the safety interlocks.
- Do not place any object between the oven front face and the door or allow soil or cleaner residue to accumulate on sealing surfaces.
- If the door or door seals are damaged, the oven must not be operated until it has been repaired by a competent person.
- It is hazardous for anyone other than a competent person to carry out any service or repair operation that involves the removal of a cover which gives protection against exposure to microwave energy.
- Liquids or other foods must not be heated in sealed containers since they are liable to explode.
- The appliance is not intended for use by young children or infirm persons without supervision. Young children should be supervised to ensure that they do not play with the appliance.
- Only allow children to use the oven without supervision when adequate instructions have been given so that the child is able to use the oven in a safe way and understands the hazards of improper use.

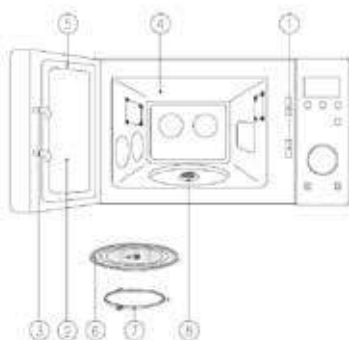

Features:

1. Safety interlock system: Prevents the oven from operating while the door is opened. The oven will only operate with the door fully closed. When the door is open the oven turns off and will only start again after the door is closed.
2. Door screen: Allows viewing of food. The screen is transparent to light, but prevents microwaves escaping.
3. Door latch: When the door is open it will automatically shut off. If the door is opened while the oven is operating, the magnetron will automatically shut off.
4. Oven cavity.
5. Door seal: The door seal surfaces prevent microwaves escaping from the oven cavity.
6. Glass cooking tray: Made of special heat resistant glass. The tray can be easily removed for cleaning. Make sure it is correctly positioned (indentation) before operating. Place food in a suitable container (dish) on the tray.
7. Roller guide: Supports the glass cooking tray.
8. Coupler: This fits over the shaft in the centre of the oven cavity's floor. This is to remain in the oven for all cooking.
9. Display: Cooking time, power level indicators and present time are displayed.

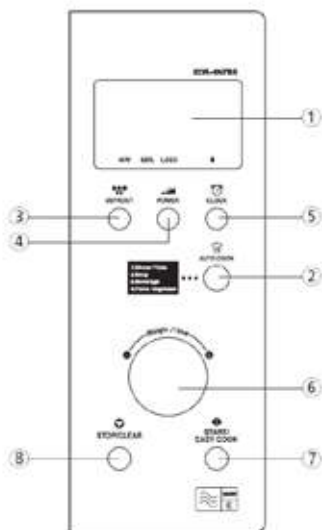

1. Information Screen
2. Auto cook: Used to cook using a programme or to reheat.
3. Defrost: Used to defrost foods by weight or time.
4. Power: Used to set power level.
5. Clock: Used to set the clock.
6. Weight and time dial knob: Used to set the time and weight.
7. Start/Easy cook: Used to start the oven operation and also increase the reheat time by 30-seconds.
8. Stop/Clear: Used to stop the oven operation or to erase all entries.

Operation Procedure

This section includes useful information about oven operation.

1. Connect the mains lead to an electrical outlet.
2. After placing the food in a suitable container, open the oven door and put it on the glass tray. The glass tray and roller guide must always be in place during cooking.
3. Shut the door. Make sure that it is firmly closed.
4. The oven light is on only when the microwave oven is operating.
5. The oven door can be opened at any time during operation by pulling the handle. The oven will automatically shut off.

6. Each time a button is touched, a BEEP will sound to acknowledge the touch.
7. The oven automatically cooks on full power unless set to a lower power level.
8. The display will show “:0” when the oven is plugged in.
9. Time clock returns to the present time when the cooking time ends.
10. When the Stop/Clear button is touched during the oven operation, the oven stops cooking and all information retained. To erase all information (except the present time), touch the Stop/Clear button once more. If the oven door is opened during the oven operation, all information is retained.
11. If the Start button is touched and the oven does not operate, check the area between the door and door seal for obstructions and make sure the door is closed securely. The oven will not start cooking until the door is completely closed or the programme has been reset.

Make sure the oven is properly installed and plugged into the electrical outlet.

Wattage Output



The power level is set by pressing the power button.

If you touch the power button once, the power level will be at 100%, if you press it twice the power will reduce by 20% and each subsequent time it is pressed the power will reduce by 20%. If it is pressed 6 times the power will go back up to full again.

Controls

Setting the Clock

When the oven is first plugged in, the display will flash “:0” and a tone will sound. If the AC power ever turns off, the display shows “:0” when the power comes back on.

1. Press the Clock button. This is a 12-hour clock system.
2. Press the Clock button once more. This is a 24-hour clock system.
3. Turn the dial knob to adjust hour.
4. Press the Clock button.
5. Turn the dial knob to adjust minute.
6. Press Clock button



This oven has multiple clock systems. If you want the 12-hour clock system omit this step.

If you selected 12-hour system, the display will show the hours from "1" to "12".

If you selected 24-hours system, the display will show the hours from "0" to "23".

The adjusted hours starts blinking.

The minute stops blinking and "00" starts blinking.

The display will show the minutes from "0" to "59".

The adjusted minute starts blinking.

i When you press the Clock button, the minute stops blinking, and the colon starts blinking. If you selected 12-hours clock system, the clock allows you to set from 1:00 to 12:59. If you selected 24-hour clock system, this digital clock allows you to set from 0:00 to 23:59.

Weight Defrosting

"Weight Defrost" lets you easily defrost food by eliminating guesswork in determining defrosting time. The minimum weight for weight defrosting is 200 grams and the maximum is 3,000 grams. Follow the steps below for easy defrosting.

1. Press Defrost button (the DEF indicator and "0" appear and the g indicator starts blinking).
2. Turn the dial knob to adjust the defrosting weight (the display will show what you selected).
3. Press Start button.

When you press Start button, the g indicator disappears and the DEF indicator starts blinking to show the oven is in the DEFROST mode. The display counts down the time to show you how much defrosting time is left in the DEFROST mode. The oven beeps during the defrosting cycle to signal that the food needs to be turned or rearranged. When the defrosting time ends, you will hear 3 beeps.

Time Defrosting

When "Time Defrost" is selected, the automatic cycle divides the defrosting time into periods of alternating defrost and stand times by cycling on and off.

1. Press Defrost button (the DEF indicator and "0" appear and the g indicator starts blinking).
2. Press Defrost button once more (the g indicator disappears and "0" is displayed).

3. Turn the dial knob to adjust the defrosting time (the display will show what you have selected).

4. Press Start button.

i Your oven can be programmed for 60 minutes 00 seconds (60:00).

When you press Start button, the DEF indicator starts blinking to show the oven is in DEFROST mode. The display counts down the time to show you how much defrosting time is left in the DEFROST mode. The oven beeps during the defrosting cycle to signal that the food needs to be turned or rearranged. When the defrosting time ends, you will hear 3 beeps.

Cooking in One Stage

1. Press Power button (select the desired power level). The M/W indicator appears and the display will show what you selected. If step 1 is omitted, the oven will cook at full power.
2. Turn the dial knob to adjust the cooking time. The display will show what you selected. (your oven can be programmed for 60 Min 00 sec (60:00)).
3. Press Start button.

When you press Start button, the M/W indicator starts blinking to show the oven is cooking. The display counts down the time to show how much cooking time is left. When the cooking time ends, you will hear 3 beeps.

i Using lower power levels increases the cooking time which is recommended for foods such as cheese, milk and for slow cooking of meats.

Cooking in Two Stages

All recipes require frozen foods to be defrosted fully before cooking.

This oven can be programmed to automatically defrost foods before cooking.

1. Press the Defrost button (the DEF indicator and "0" appear and the g indicator starts blinking).
2. Turn the dial knob to adjust the defrosting weight (the display will show what you have selected).
3. Press Power button (select the desired power level x 3). The M/W indicator appears and the display will show what you have selected.

4. Turn the knob to adjust the cooking time (the display will show what you selected).
5. Press Start button.

When you press Start button, the DEF and M/W indicators come on to confirm the power levels selected. The DEF indicator starts blinking to show you that the oven is in DEFROST mode. The display counts down the time remaining in DEFROST mode. When the oven beeps, turn over, break apart and/or redistribute the food. At the end of DEFROST mode, the oven will beep and start M/W cook. The DEF indicator disappears and the M/W indicator starts blinking. The display counts down the time remaining in M/W mode. When M/W cook ends, you will hear 3 beeps.

Easy Cooking

Easy Cook allows you to reheat for 30 seconds at 100% (full power) by simply pressing the Easy Cook button.

1. Press Easy Cook button (when you press Easy Cook button, "30" appears). After 1.5 seconds, the oven starts reheating. When the cooking time ends, you will hear 3 beeps.

Auto Cook

Auto Cook allows you to cook or reheat many of your favourite foods by repeatedly touching Auto Cook button.

1. Press the Auto Cook button (when you press the Auto Cook button once, "AC-1" is displayed. By repeatedly pressing this button, you can select one of the four menu programmes.
2. Turn the dial knob to adjust the desired quantity (the display will show what you have selected).
3. Press Start button. When you press the Start button, the display changes into cooking time and the oven starts cooking. When the cooking time ends, you will hear 3 beeps.

Food	Press Autocook button	Display	Weight	Directions
Dinner Plate	once	AC-1	350g	Put foods on the microwave plate and cover with vented plastic wrap.
			450g	
Soup	twice	AC-2	350g	Pour soup in microwave bowl or mug. Stir before serving.
			450g	
Beverage	three times	AC-3	1 CUP (200ml)	Pour beverage in microwave mug and place it on the turntable. Do not cover. Stir before serving.
			2 CUPS (200mlx2)	
			3 CUPS (200mlx3)	
Fresh vegetable	four times	AC-4	200g	Wash and put in casserole. Add no water if vegetables have just been washed. Cover tender vegetables with lid and stir after cooking.
			400g	

Child Safety Lock

Safety Lock prevents unwanted oven operation such as by small children. To set, press and hold Stop/Clear button for 3 seconds. Lock indicator appears and a beep sounds. To cancel, press and hold Stop/Clear button for 3 seconds. Lock indicator disappears and a beep sounds.

To Stop The Oven While The Oven is Operating

- Press Stop/Clear button.
- You can restart the oven by pressing Start button.
- Press Stop/Clear button once more to erase all instructions.
- You must enter in new instructions.
- Open the door
- You can restart the oven by closing the door and pressing Start button.



Oven stops operating when door is opened.

POWER SUPPLY		230V AC 50Hz SINGLE PHASE WITH EARTHING
MICROWAVE	POWER CONSUMPTION	1200 W
	OUTPUT POWER	800 W
	FREQUENCY	2450 MHz
OUTSIDE DIMENSIONS (W X H X D)		460 X 275 X 360 mm
CAVITY DIMENSIONS (W X H X D)		330 X 220 X 300 mm
NET WEIGHT		APPROX. 12.2KG
TIMER		60 min. 55sec.
POWER LEVELS		5-LE-EL5

Microwave Specifications Before You Call for Service

Refer to the following checklist, you may : prevent an unnecessary service call.

The oven doesn't work.

- Check that the power cord is securely plugged in.
- Check that the door is firmly closed.
- Check that the cooking time is set.
- Check for a blown circuit fuse or tripped main circuit breaker in your caravan.

Sparking in the cavity:

- Check utensils. Metal containers or dishes with metal trim should not be used.

If there is still a problem, contact the service station.

Questions and Answers

Q: I accidentally ran my microwave without any food in it. Is it damaged?

A: Running the oven empty for a short time will not damage it. However, it is not recommended.

Q: Can the oven be used with the glass tray or roller guide removed?

A: No. Both the glass tray and roller guide must always be used in the oven while cooking.

Q: Can I open the door when the oven is operating?

A: The door can be opened at any time during the cooking operation. The microwave energy will be instantly switched off and the time setting will maintain until the door is closed.

Q: Why do I have moisture in my microwave oven after cooking?

A: The moisture on the side of your microwave oven is normal. It is caused by steam from cooking food hitting the cool oven surface.

Q: Does microwave energy pass through the viewing screen in the door?

A: No. The metal screen bounces back the energy to the oven cavity. The holes are made to allow light to pass through. They do not let microwave energy pass through.



Do not attempt to service the oven yourself!

27. CARBON MONOXIDE ALARM

A FireAngel CO-9B battery-operated alarm is fitted near to the ceiling in your caravan.

Features

- An advanced electro-chemical sensor designed to accurately measure low-high levels of carbon monoxide (CO) providing an early warning of toxic CO levels in your caravan.
- Detects carbon monoxide continuously.
- Resistant to false alarms caused by usual household contaminants.
- Sounds a large 85dB alarm (at 1 metre (3 feet)) to alert you in case of an emergency.
- Test/Reset button.
- Simple to mount, portable, ideal for travelling.
- Conforms to the British Standards Institute (BSI) Carbon Monoxide Standard BS EN 50291: 2001.
- 7 year warranty.
- Test the sounder, batteries and circuitry.
- Allows you to test the sensor by introducing a source of CO into the detector.
- Silence the loud 85dB sounder during an alarm (only possible when current CO level is less than 50ppm (Parts Per Million the accepted level of carbon monoxide in the air)).

Testing the Sounder Batteries and Circuitry.

- Test the sounder, batteries and circuitry by pressing and holding the Test/Reset button for 1 second to confirm that the detector is operating properly. The sounder should sound as soon as the button is pressed, and the alarm LED will illuminate red, indicating that the sounder is working and the batteries are providing power to the unit. The test for the sounder batteries and circuitry should be performed weekly

Testing the Sensor

- All sensor testing should be carried out by a responsible adult. This test should only be performed once a month. Excessive testing will cause the battery life to be shortened.



CO testers may be used in order to avoid having to burn cigarettes, incense sticks etc.

Please read all steps thoroughly before attempting to test your alarm.

- If the alarm is wall mounted, remove by unhooking the unit from the wall fixing screws.
- Cover the sounder vents with one hand and hold the Test/Reset button down with your thumb/finger until the power LED illuminates green and the sounder sounds for a second time. (This should happen after 5 seconds.) Release the Test/Reset button and the power LED will flash green once every second. This indicates that the sampling rate of the detector has increased and can be tested using a known source of CO.
- Light an incense stick or a cigarette using a match or a lighter. If using an incense stick, be sure to blow the flame out so that the incense stick is smouldering. Extinguish the lighter, or put out the match and place it into a dish of water.
- Turn the detector on its side so that the vents on the right hand side of the detector are pointing downwards. Hold the burning incense stick or cigarette around 15cm (6") below the detector. An increase in the localised carbon monoxide level within the sensor to more than 50ppm will cause the sounder to sound for one cycle of four loud beeps. The power LED will no longer flash green every second but will revert to flashing once a minute. The detector will revert back to the ordinary operating mode (it may take up to 2 minutes for the localised level of carbon monoxide to fall below 50ppm). Now move the source of CO away from the detector as the test is finished.
- Put out the incense stick or cigarette by placing it into a dish of water. Ensure all flames have been extinguished.



If the localised carbon monoxide level within the sensor does not reach 50ppm during the test, the sensor test will stop automatically after 3 minutes.

Understanding Your Product's Indicators

The higher the concentration of carbon monoxide detected by the detector, the quicker it will respond. When sufficient carbon monoxide is detected a loud audible signal

(85dB at 1m/3ft) will be emitted and the alarm LED will flash red once every second.

The alarm will sound:

- Between 60 and 90 minutes when exposed to 50ppm of CO.
- Between 10 and 40 minutes when exposed to 100ppm of CO.
- Within 3 minutes when exposed to 300ppm or more CO.
- There will be an audible "chirp" if the battery, sensor or circuitry has any fault including a low battery. This sound will continue once a minute for 30 days. (The battery must be replaced to ensure occupant safety.)
- If the device continues to chirp despite having new batteries and the product is still in warranty then contact technical support for the device. If the device is no longer in warranty replace it immediately.

Maintaining/Testing Your Detector

Your detector will alert you to potential hazardous CO concentrations in your caravan when maintained properly. To maintain your FireAngel detector in proper working order and to ensure that the sensors will last for the lifetime of the product, it is recommended that you:

- Test the sounder, batteries and circuitry of your detector once per week by pressing and holding the Test/Reset button for 1 second.
- Keep the detector free of dust by gently vacuuming with a soft brush attachment when required.

To prevent the possibility of contaminating the sensor in your detector and thus affecting its reliability:

- Never use cleaning solutions on your detector. Simply wipe with a damp cloth.
- Do not paint the detector
- Do not spray aerosols on or near to the detector.
- Do not use any solvent based products near to the detector

Failure of any test should be reported to the manufacturer's technical support line.
+44 (0)800 141 2561



Do not attempt to repair your CO Detector. Do not remove any screws or open the main casing of your

detector. Any attempt to do so may cause malfunction and will invalidate the warranty.



Never ignore any alarm.

What to Do in the Event of an Alarm

- Keep calm and open all the doors and windows to ventilate your caravan.
- Stop using all fuel burning appliances and ensure where possible they are turned off.
- Evacuate the caravan leaving doors and windows open.
- Do not re-enter the caravan until the alarm has stopped.
- Get medical help for anyone suffering the effects of CO poisoning and advise that CO poisoning is suspected.
- Do not use the caravan again until you have had a full service of all appliances by your supplying retailer. In the case of gas appliances they must be tested by a GAS SAFE registered installer. Please contact your Bailey retailer for more details.
- The electro-chemical sensors used in the carbon-monoxide alarm have a limited lifespan-therefore it is recommended that a CO alarm is replaced every 5-7 years after manufacture or in accordance with the unit's instructions. Check the manufacturing date on the alarm's label.

28. BATHROOM CARE

Do not expose the bathroom plastic fittings to cleaning products or abrasive material containing concentrated perfumes, body oil, linseed oil, gritty or abrasive substances, solvents (white spirits, antifreeze etc). These may cause permanent damage to the material. Always clean the bathroom straight away after use with warm soapy water and a soft cloth. Stubborn stains may be removed with a solution of lemon juice and water, at a solution of 1 part water to 1 part lemon juice.

Thetford bathroom cleaner is suitable for cleaning the shower and vanity unit plastic items (sinks, shower trays, Thetford toilets etc).



Domestic cleaning products are not to be used to clean the shower/vanity unit plastic items.

Some mouthwashes can cause plastic items to crack and for this reason should not be used.

Bathroom Shower Tap

Your shower tap has a high quality finish and should be treated with care to preserve the visible surfaces.

All surface finishes will wear if not cleaned correctly; the only safe way to clean your mixer is to wipe with a soft damp cloth.

Stains can be removed using washing up liquid. All bathing powders and liquids will damage the surface of your fitting, even the non-scratch cleaners.

Mirrors

Cleaning: it is best to clean mirrors with a cleaner that does not contain ammonia. If you are not sure of the ingredients, spray a clean lint-free cloth with the cleaner so as not to get the liquid near to the edge of the mirror which is where ammonia would cause the most harm.

- Use a soft, dust-free cloth.
- Warm water- try bottled water if your tap water is mineral rich.
- For stubborn dirt use an oil free steel wool pad, carefully and precisely.
- Spray cleaners on your cloth, not directly onto the mirror.
- Keep the mirror frame dry.
- Never use a razor blade on a mirror, even if the mirror has paint specks on it. Always use hot water first.

- If you find black spots on your mirror you may have damaged the silvering behind the mirror's glass. If this is the case you may be able to cover the spots from the front.
- Moisture along a mirror's edge can seep in and harm the reflective backing.
- Keep in mind that long-term exposure to direct sunlight may damage some mirrors.

29. THETFORD C262 TOILET

The Thetford Cassette Toilet is a high quality product. The toilet forms an integral part of your caravan bathroom, thanks to its functional design which combines modern styling and ease of use.

The C262 Cassette Toilet is manufactured from high quality synthetic materials which makes it a durable, user and maintenance friendly toilet.

The toilet is made up of two parts: a permanently fixed part and a waste holding tank that is accessible from the outside. The removable waste holding tank is located under the toilet bowl and can be removed via a door on the outside of the caravan. The Thetford Cassette Toilet is the solution to the sanitary problem in your caravan.

These operating instructions cover Thetford Cassette Toilet C262 CWE.



Parts

1. Cover
2. Seat
3. Swivelling toilet bowl
4. Blade handle to open and close blade
5. Control panel
- 5a. Electric flush button
- 5b. Waste holding tank level indicator
6. Pull handle
7. Pour out spout
8. Cap with measuring cup
9. Automatic pressure release vent
10. Vent button
11. Sliding cover

12. Blade opener
13. Waste holding tank mechanism
14. Wheel
15. Service door
16. Water fill door
17. Console with flush-water tank
18. Filter for electric ventilator
19. Location waste pump-out system

Preparing for use (standard)

- Open the access door on the outside of your caravan.
- Remove the waste holding tank by pulling the safety catch (which holds the tank in place) upwards.
- Pull the waste holding tank outward to the stop. Tip it slightly and take the tank fully out.
- Place the tank upright and turn the rotating emptying spout upwards. The emptying spout ensures that the tank can be easily and hygienically emptied.
- Remove the cap, with the measuring cup inside, from the emptying spout and pour the correct dosage of Thetford toilet fluid (see product label) into the holding tank. This avoids unpleasant smells and keeps the inside of the tank clean. Next add approximately 2 litres of water-enough to ensure that the bottom of the waste holding tank is covered. Screw the cap back onto the emptying spout and turn back to its original position. The emptying spout measuring cup is supplied inside the toilet and needs to be fitted to the pour out spout before first use of the toilet. Never add toilet fluid directly via the blade or the toilet bowl as this could damage the lip seal of the waste holding tank. Always pour the fluids via the emptying spout. The lip seal is the water tight seal around the top of the tank.
- Slide the waste holding tank back into its original position via the access door. Make sure that it is secured with the safety catch. Close the access door and lock it. Your Thetford toilet is now ready to use.
- Never use force if you cannot get the tank back into place easily. This may cause serious damage. If blockage occurs, always check that the blade handle is in the correct position.
- For toilets with own flush-water tank: open the water filling door and fill the flush-water tank with the correct dosage of

Aqua Rinse. This Thetford toilet fluid keeps the flush water fresh and improves the flushing. Next, fill up the flush-water tank with clean water (approximately 8 litres) using a watering can or hose. Your toilet is now ready to use.

Using The Toilet (Standard)

- Turn the bowl to the desired position with the lid closed and using both hands.
- To activate the control panel, press the flush-button once. The control panel display will stay activated for approximately 5 minutes. Run some water into the bowl by pressing the flush button again briefly.
- The toilet may be used with the blade open or closed. To open the blade, slide the blade handle under the toilet bowl sideways. After use, open the blade (if still closed) and flush the toilet by pressing the flush button for several seconds (if necessary re-activate the control panel). Close the blade after use. If your toilet has its own flush-water tank, please make sure that you do not travel with a flush-water tank that is too full. Do not travel with water in the toilet bowl. Failure to adhere to this notice may result in water damage to your caravan.

Emptying

- The waste holding tank has a capacity of 18 litres and requires emptying when the red light (LED) on the toilet control display lights up. The waste holding tank only has capacity for two more litres which is no more than two to three further uses.
- Place the waste holding tank in an upright position (pull-out handle at the top, wheels at the bottom). Slide the handle sideways-to the front of the tank-until it snaps out of its locked position. Pull the handle up and wheel the waste holding tank to an authorised waste disposal point. Push the handle back into its locked position. Turn the emptying spout upwards and remove the cap from the spout. Hold the waste holding tank in such a way that during emptying you can operate the vent plunger with your thumb. To empty the tank without splashing, depress the vent plunger while emptying the tank. After emptying, rinse the tank and blade thoroughly with water.
- Do not vigorously shake the tank or use high pressure water cleaners. This may cause damage to the tank's interior.

- The vent plunger should only be depressed once the emptying spout is pointing downwards. Prepare the toilet for re-use if required. Slide the waste holding tank into the toilet and close the access door.

Cleaning and Maintenance

- The toilet should be cleaned and maintained regularly, depending on the amount of use. To clean Thetford toilets, we advise using water and Thetford Bathroom Cleaner. Never use bleach, vinegar or other powerful household cleaners that contain these substances. These may cause permanent damage to the seals and other toilet components.

Caravan Equipment

Toilet Bowl

- Squirt Thetford Bathroom Cleaner into the toilet bowl.
- Flush the toilet bowl with water and wipe down the rest of the toilet with a damp cloth.
- Clean seat and lid. The seat and lid can easily be removed: lift the seat and lid assembly and pull the round pins (inside the assembly) outwards from the pin holes. After cleaning, replace the seat and lid by positioning the round pins in front of the pin holes and push the lid and seat downwards.
- To keep your flush-water fresh and to prevent deposits forming in your toilet bowl, add a correct dosage of Aqua Rinse in your flush water tank.
- Tip! For a really shining toilet, dry with a soft dry cloth after cleaning.

Waste Holding Tank

To keep your waste holding tank fresh and clean, Thetford has developed a number of different toilet fluids. Thetford toilet fluids suppress smells, reduce formation of gas, promote breakdown of toilet waste and increase the life span of a mobile toilet. We advise a thorough cleaning of the waste holding tank once each season. Next to using the Thetford's Cassette Tank Cleaner, which is the powerful cleaning agent for the periodical cleaning of the waste holding tank of your toilet, we suggest the following.

- Remove the removable mechanism from the waste holding tank by turning it anti-clockwise and rinse it under a tap.

- Remove the cover plate from the automatic pressure release vent by prising it up using a small screwdriver. Use one hand to push the automatic pressure release vent open while holding the float of the automatic pressure release vent on the inside of the tank with the other hand. Push the float upwards, turn it 180 degrees and remove it from below. Remove the rubber seal underneath the float. Rinse the float and rubber seal under a tap. Replace the rubber seal and float for the automatic pressure release vent using the same method in reverse.
- The rubber seals in the toilet (the lip seal, the mechanism seal, the automatic pressure release vent seal and the cap seal) should be regularly cleaned with water and treated with Thetford High Grade Seal Lubricant. This will ensure that the seals remain flexible and in good condition. If the toilet is not to be used for any length of time, it is important to treat the seals with Thetford High Grade Seal Lubricant after cleaning.

Never use Vaseline or any vegetable oil except olive oil. These may cause leakage or malfunction. The lip seal is a part of the toilet that is subject to wear. Depending upon the extent and manner of use, the seals will become less effective and will need replacing periodically.

Winter Operation

You can use your Thetford Cassette Toilet as normal in cold weather as long as the toilet is situated in a heated location. If there is a risk of freezing we advise that the toilet is drained. For environmental reasons the use of antifreeze, such as that used in car radiators, is not recommended.

30. ECOCAMEL SHOWER HEAD

Your caravan is fitted with an Ecocamel shower head.

- It saves water, energy and money.
- It has a wipe clean head to prevent the build-up of lime scale
- Uses a maximum of 8 litres a minute.

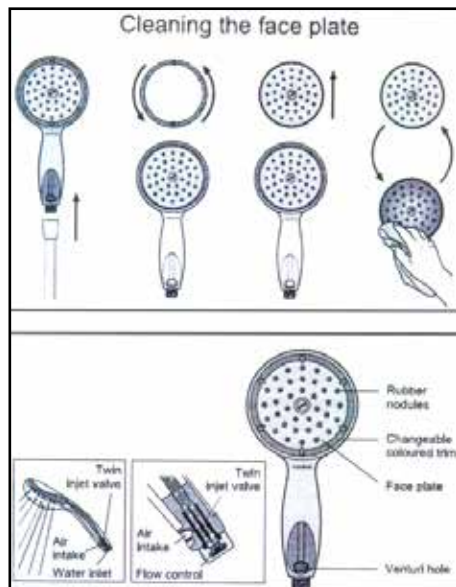

After showering, when the shower is turned off, your Ecocamel shower head simply drains off any excess water through the air intake. Clean your Ecocamel shower head with a damp cloth. Do not use any abrasive or chemical cleaners. Should any scale build up on your shower head's spray plate you can de-scale it by rubbing the nozzles with your thumb.

The Ecocamel shower head will fit all caravan showers and is available from the Bailey Parts department.

parts@bailey-caravans.co.uk

24. REFRIGERATORS

Winter Operation—Dometic Refrigerators



Please check that the ventilation grilles or the flue outlets are not blocked by snow, leaves etc.

24a. Dometic Refrigerator Model RM8550/RMS8550/RM8500- Used On Pegasus GT65 and Pursuit Models

Cleaning

Before starting up the refrigerator, it is recommended to clean inside and repeat this at regular intervals. Use a soft cloth and lukewarm water with a mild detergent. Then wipe out the appliance with clean water and dry thoroughly.



To avoid deterioration of materials:
Do not use soap or hard, abrasive or soda-based cleaning agents.
Do not allow the door seal to come into contact with oil or grease.



Operating modes and use of the refrigerator:

This refrigerator is equipped to operate on three power modes: AC mains power (230v) 12v DC or gas (propane/butane liquid gas).

Select the desired power mode by the energy selector switch.

The cooling unit is silent in operation.

The refrigerator works reliably on slopes of up to 6 degrees (5 degrees with models starting from 140 litres capacity).

When the appliance is started for the first time, there may be a mild odour which will disappear after a few hours. Air the living space thoroughly.

The refrigerator will take several hours to reach its operating temperature in the cooling compartment.

Control Elements Of Energy Selections (BATTERY IGNITER)

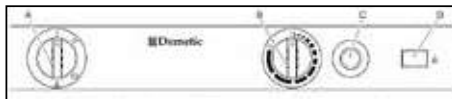

- A= Power On switch/ Energy selector switch
- B= Temperature selection
- C= Manual igniter (battery igniter)
- D= Gas operation indicator

Explanation

The refrigerator is equipped to operate on mains power, 12v DC or liquefied gas. Select the desired power supply by turning the energy selector switch A. The energy selector switch A has four settings: OFF, AC mains voltage, DC (battery) and gas.

Electrical operation

Appliances with battery igniter

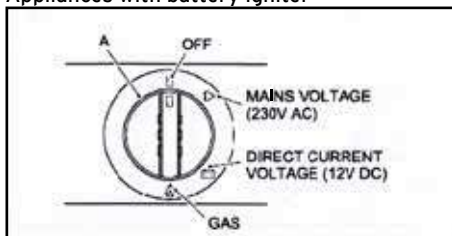

Switch on the appliance by turning the energy selection switch A clockwise to position:

230v Operation

12v Operation



In order to prevent discharge of the on-board battery, 12v operation should only be used while the car is running.

Gas Operation (Liquid Gas)



The refrigerator must be operated using liquefied gas (propane or butane NOT natural gas or town gas). When using LPG please consider that the burner needs cleaning at shorter intervals due to the gas combustion method (annually).

For physical reasons, ignition faults could occur starting from an altitude above sea level of approx. 1,000m/3,280 ft. (This is not a malfunction!)

On the initial refrigerator start-up or after a cylinder change, air may be trapped in the gas line. To purge the air from the line, switch on the refrigerator and any other gas appliances (e.g. stove) for a short time. The gas ignites without delay.

As a basic rule, gas operation is prohibited in petrol stations.

Prior to starting the refrigerator in gas mode:

- Open the gas cylinder valve.
- Open the shut-off valve for gas supply to the refrigerator.

Appliances with Battery Igniter

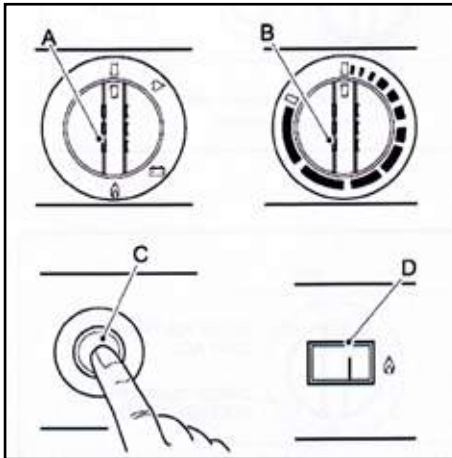

Each refrigerator with manual ignition is equipped with an automatic flame safety valve which interrupts the gas supply after approx. 30 seconds when the flame has extinguished.

Door Locking

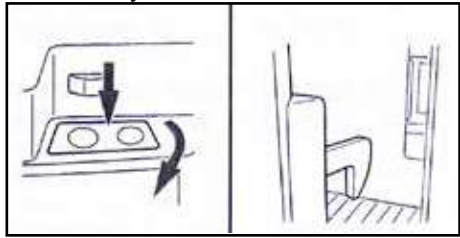

- Open the door by pressing the locking button and pull again.
- Shut the door again by pushing it to close. The snapping into the lock can be heard.

Fixing and releasing the door lock hook when parking the vehicle

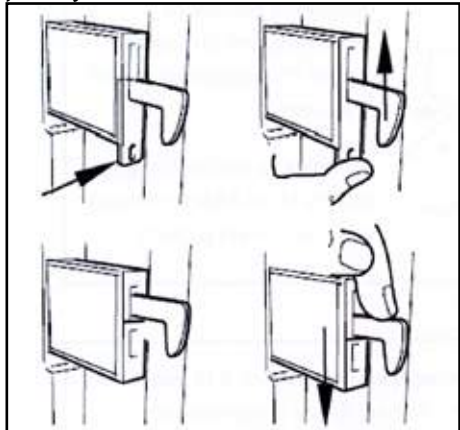

- If the vehicle is parked for a longer period of time, the locking hook may be clamped by means of a lock-bar. The door may now be opened by just pulling it without the need of pressing the locking button.
- Restore the original position by pushing the hook down.



As a basic rule, shut and lock the refrigerator door before commencing your journey.

Removable freezer compartment

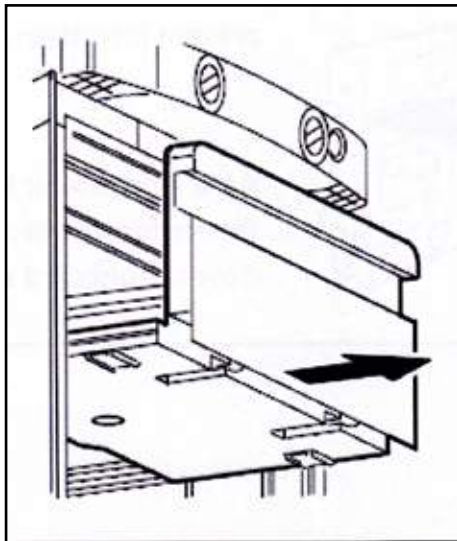
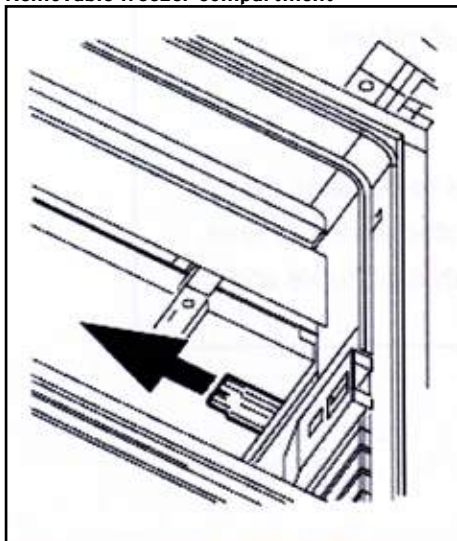

- To enlarge the cooling space just remove the freezer compartment.
- Unlock the freezer compartment on both sides and pull it out.
- Store the freezer compartment safely in order to prevent damage.

Positioning the storage racks

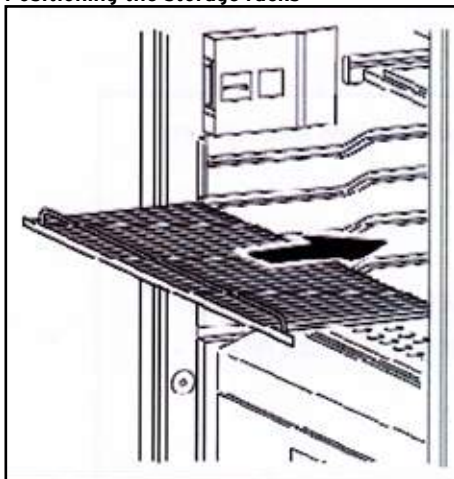

- The storage racks may be pulled out by smoothly lifting them and may be positioned as desired.

i Once the freezer compartment is removed, an additional storage rack may be installed. The storage rack is a piece of extra equipment and may be obtained from Dometic.

Exchange of the igniter's battery

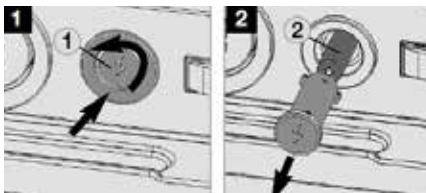

- Unlock the battery by depressing and turning the button (C) approximately 90° Anti-Clockwise.
- Remove cap and exchange battery (1.5V AAA/R3/Micro). Observe correct polarity.

Shutting off the refrigerator

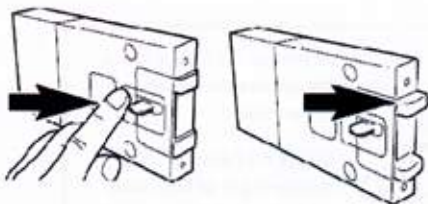
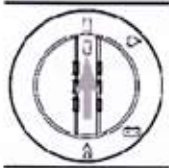

- Set energy selector switch A to position OFF. The appliance is switched off.
- Release the locking mechanism of the door lock by pushing it and shift it to the front. If the door is shut in this position, a small gap is nevertheless kept open to prevent formation of mildew.
- If the refrigerator is to be taken out of service for an extended period of time, close the on-board shut-off valve and the door.

Lighting

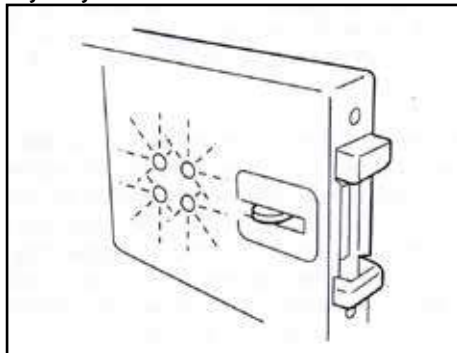

- If the door is open for more than two minutes, the sensor-controlled interior lighting is automatically cut off (except for models with battery igniter).

24b. Dometic Refrigerator Model RMD8551 used on Unicorn Twin Axles

Cleaning

Before starting up the refrigerator, it is recommended to clean inside and repeat this at regular intervals. Use a soft cloth and lukewarm water with a mild detergent. Then wipe out the appliance with clean water and dry thoroughly.



To avoid deterioration of materials:

- Do not use soap or hard, abrasive or soda-based cleaning agents.
- Do not allow the door seal to come into contact with oil or grease.

Operation mode and use of the refrigerator



This refrigerator is equipped to operate on three power modes: AC mains power (230v) 12v DC or gas (propane/butane liquid gas)

Select the desired power mode by the MODE button. Appliances with automatic energy selection (AES) are additionally provided with "automatic mode" function. The AES system automatically selects the best energy source for each particular situation.

Maintenance

In compliance with the applicable regulations, please note that the gas unit and the connected ventilation ducts must be checked by authorised technical personnel after first use and after every other year for compliance with the European Standard EN 1949. A test certificate has to be issued. It is the user's responsibility to arrange this test.

The gas burner must be inspected and cleaned as necessary at least once a year. When using liquid petroleum gas (tank or refill cylinders) the maintenance interval is reduced to half-yearly or quarterly.

Keep the evidence of maintenance work carried out on your refrigerator.

Work on gas and electrical equipment shall be carried out by an authorised customer services department.

We recommend maintenance following an

extended shut down of the vehicle. Please contact Dometic Customer Services.

Explanation of operating controls

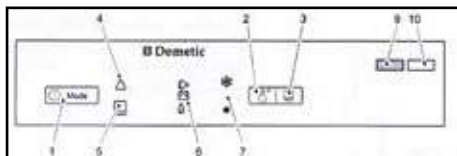

(Power on switch/energy selector switch (MODE)

Temperature selection

Power On switch frame heating

Indicator LED failure

Indicator LED frame heating

Indicator LED/operating mode display

Temperature level display.

NOT APPLICABLE

External display "failure" (red)

External display "in operation" (blue)

Explanations

The refrigerator is equipped to operate on mains power, 12v DC or liquid gas. Select the desired power supply by turning the energy selector switch (1).

The energy selector switch (1) has four settings: Off, mains voltage (230v AC), direct-current voltage (battery, 12v DC), gas (liquid gas propane/butane)

Switch the refrigerator ON or OFF by pressing button (1) for 3 seconds. Button (1) allows you to either initiate the requested energy supply or activate dimming of the LED brightness. By pushing once, the indicators illuminate for 10 seconds.

Button (3) allows you to switch on the frame heating in order to avoid a rising of condensation water due to high humidity. During the frame heating operation the indicator LED (5) is illuminating.

Electrical Operation

MES Appliances (manual energy selection)

To start the refrigerator, press button (1) for 3 seconds.

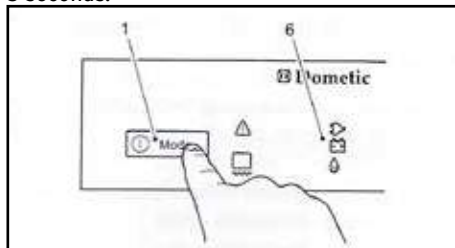

The LED (6) of the previously selected operating mode illuminates:

230v operation

12v operation

Gas operation

Change the operating mode by pressing button (1) again. The appropriate indicator LED will illuminate.

Press button (1) several times until the indicator LED (6) illuminates.

The ignition process is activated automatically by means of an automatic igniter.

The ignition system will make 2 ignition attempts with 25 seconds interval when the burner fails to light. If repeated attempts fail to start the operation, a fault is indicated (please refer to failure indication found on page 109).

Setting of The Cooling Compartment Temperature

Select the desired cooling compartment temperature by pressing button (2).

The LED display (7) of the selected temperature setting is illuminated.

The scale starts with MIN position at the bottom LED position (small crystal = highest temperature) and climbs up to MAX position at the upper LED position (largest crystal = lowest temperature). Note: The temperature levels do not relate to absolute temperature values.



The cooling unit's performance is influenced by ambient temperatures. Please select the medium setting for ambient temperatures between +15°C and +25°C. The unit operates within its optimum performance range. Dometic refrigerators work according to the absorption principle. For physical reasons, an absorption system responds slowly to changes made by the thermostat controller, by loss of cooling energy through opening the door or during storing food. The devices meet the cooling performance requirements of the Climatic Class SN acc. To EN/ISO 7371 in the temperature range of +10°C to 32°C ambient temperature.

For temperatures below +10°C, winter covers should be installed. For ambient temperatures exceeding +32°C for a longer period of time, it is recommended installing Dometic additional fan (item no. 241 2985 00).

Additional Features (MES)

The brightness of the display reduces after a few seconds if no other buttons are pressed. If the door is open, the interior lighting is switched off automatically after 2 minutes. Failures are indicated by flashing of the failure indicator LED.

Should the door be kept open for too long (more than 2 minutes), the blue external LED starts flashing until the door is closed.

Frame Heating

All models are equipped with a frame heating (12v DC/3.5W) around the freezer compartment. During summer months with high temperatures and humidity the metal frame may have water droplets forming. To evaporate these droplets switch on the frame heating with switch (3). The LED (5) indicates that the heating is on.

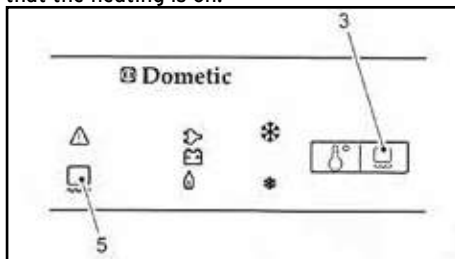

The frame heating is in operation with a pre-setting of 2 hours and switched off afterwards automatically. The frame heating can be deactivated every time by pressing the button (3).

Door Locking

Manual door lock

Open the door by pressing the locking button and pull open.

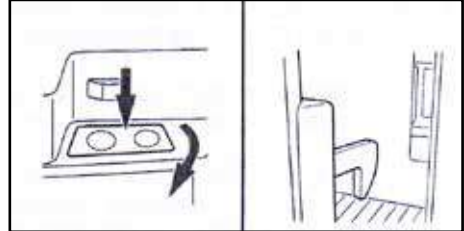

Shut the door again by pushing it to close. The snapping into the lock can be heard. While the vehicle is parked, the locking hook may be fixed to facilitate opening of the door.

Fastening and releasing the door lock hook when parking the vehicle.

If the vehicle is parked for a longer time, the locking hook may be clamped by means of a lock bar. The door may now be opened by just pulling it without need of pressing the locking button.

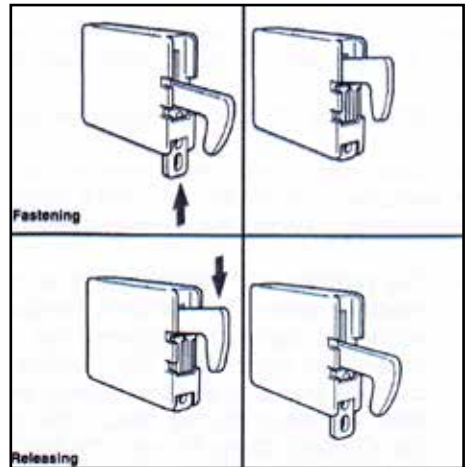

As a basic rule, shut and lock the refrigerator before you start your journey.

Positioning Storage Racks

The storage racks may be pulled out by loosening the two locking devices (1) underneath. For loosening pull the slider to the middle, for fastening pull them sideways.

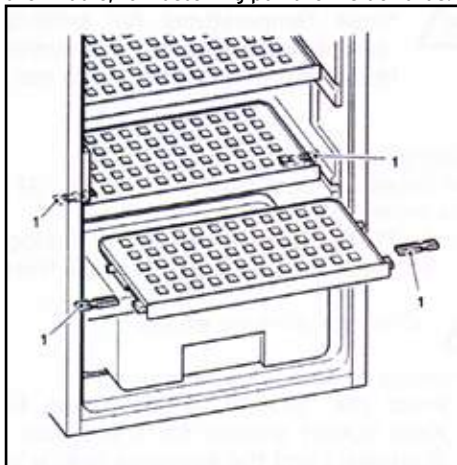

Lighting

If the door is open for more than 2 minutes, the interior lighting is automatically cut off.

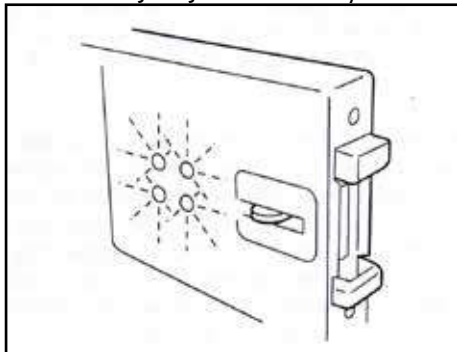

Please contact the authorised Dometic Service Centre if a failure occurs.

Storing Food and Making ice Cubes

Storing food in the cooling compartment

Switch the refrigerator on approx. 12 hours before filling it.

Always store pre-cooled foods in the refrigerator. Make sure that the food is well cooled when it is bought and also when transporting it. Use insulated cooling bags.

Open the refrigerator door only for a short period of time when moving products.

Products must be packed - best of all in

closed containers, wrapped in aluminium foil or similar - and stored separately from each other, in order to prevent drying out or odours. Allow foods that have been warmed up to cool down before storing.

Avoid storing products in the refrigerator that could emit volatile flammable gases.

Do not expose the refrigerator to direct sunlight.

Please bear in mind that the temperature inside a closed vehicle increases sharply if exposed to sunlight and that this can reduce the efficiency of the refrigerator.

Ensure that air circulation of the cooling unit is not obstructed. Keep the ventilation grilles free from obstructions.

Storing Food in the Freezer Compartment

Do not keep carbonated drinks in the freezer.

The freezer compartment is suitable for making ice cubes and for short-term storage of frozen food. It is not suitable as a means of freezing foods.



When ambient temperatures are lower than +10°C and the refrigerator is exposed to these temperatures for extended periods of time, an even regulation of freezer temperature cannot be guaranteed for system-related reasons. This can cause the temperature in the freezer to rise and the stored goods to melt.

Making Ice Cubes

Ice cubes are best frozen overnight. At night, the refrigerator has less work to do and the unit has more reserves.

Fill the ice cube tray with drinking water.

Place the ice cube tray in the freezer compartment.



Only use drinking water.

Shutting off the Refrigerator

Press the "MODE" button to switch off. Keep button pressed for 3 seconds. The display disappears and the appliance is fully switched off.

Release the locking mechanism of the door lock by pushing it and shift it to the front. If the door is shut in this position, a small gap is nevertheless kept open to prevent formation

of mildew.

If the refrigerator is to be taken out of service for an extended period of time, close the on-board shut-off valve and the cylinder valve.

Defrosting

As time goes by, frost builds up on the fins inside the refrigerator. A layer of frost thicker on one side may occur and does not represent a malfunction. When this layer of frost is about 3mm thick, the refrigerator should be defrosted.

Switch off the regulator, as described in section "Shutting off the refrigerator".

Remove all food and the ice cube tray.

Leave the refrigerator door open to allow air to enter and prevent formation of mildew.

After defrosting (freezer compartment and fins free of frost), wipe both cooling compartments with a cloth.

Water thawing in the main compartment of the refrigerator runs into an appropriate container at the back of the refrigerator. From there the water evaporates.



The layer of ice must never be removed forcibly, nor may defrosting be accelerated using a heat source!

Winter Operation



In winter, check that the ventilation grilles and the exhaust duct system (1) have not been blocked by snow, leaves, etc.

Information on failure display and troubleshooting.

If a malfunction occurs, the indicator LED "Failure" (1) flashes and LED (2) simultaneously. If the failure is not resolved, it repeats after 1 hour.

Status messages on the display.



LED is flashing

230v mode: "230v" is not available or voltage is too low



LED is flashing

12v mode: "12v" is not available or voltage is too low.



LED is flashing

Gas/Auto mode: Flame not ignited.

All temperature setting LEDs are flashing
Temperature sensor defective, refrigerator works on mid temperature setting.



LED + all temperature setting LEDs are flashing
230v- Heating element defective.



LED + all temperature setting LEDs are flashing
12v- Heating element defective.

Troubleshooting



Before notifying the authorised Service Centre, please check whether:

- The instructions in the section "Operating the refrigerator" have been followed.
- The refrigerator is level.
- It is possible to operate the refrigerator with any available power source.

Failure: The refrigerator does not cool sufficiently.

Possible cause and action you can take
q) Inadequate ventilation to the unit.

a) Check that the ventilation grilles are not covered.

q) Thermostat setting is too low.
a) Set thermostat to a higher level.

q) The condenser is heavily frosted.

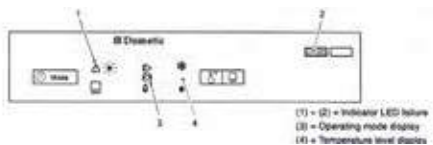

a) Check that the refrigerator door closes properly.

q) Too much warm food has been stored

a) Allow warm food to cool down before storage.

q) Has the appliance only been running for a

short period of time?

- a) Check whether the cooling compartment works after 4-5 hours.
- q) Ambient temperatures too high.
- a) Regularly remove ventilation grilles.

Failure: The refrigerator does not cool in gas operation mode.

Possible cause and action you can take

- q) Gas cylinder empty.
 - a) Change gas cylinder.
 - q) Is the supply shut-off device open?
 - a) Open the shut-off device.
 - q) Air in the gas pipe?
 - a) Switch off the appliance and start again.
- Repeat this procedure 3-4 times, if necessary.

Failure: The refrigerator does not cool in 12v operation.

Possible cause and action you can take

- q) On-board fuse defective.
- a) Fit new fuse.
- q) On-board battery discharged.
- a) Check battery, charge it.
- q) Engine not running.
- a) Start engine.
- q) Heating element defective (please also refer to failure indication).
- a) Please inform Dometic Customer Services.

Failure: The refrigerator does not cool in 230v operation.

Possible cause and action you can take

- q) On-board fuse defective.
- a) Fit new fuse.
- q) No connection to supply voltage.
- a) Establish power connection.
- q) AES: gas operation despite connection to the supply voltage.
- a) Appliance switches to gas operation due to insufficient supply voltage (automatically switches back to 230v operation).
- q) Heating element defective (please also refer to failure indication).
- a) Please inform Dometic Customer Services.

Maintenance

Please visit www.dometicapproved.co.uk or telephone +44 (0) 844 626 0130 to locate your local service centre. Installation may only be carried out by authorised personnel. We recommend contacting your Dometic Service Centre.

EN 1949 stipulates that the appliance's gas equipment and its associated fume system must be inspected after installation and a certificate issued.

When using the fridge for extended periods on gas operation Dometic recommend a seasonal service is carried out by authorised personnel.

It is the user's responsibility to arrange for inspections after purchase.

It is recommended that the gas burner be inspected and cleaned as necessary at least once a year.

We also recommend maintenance following an extended shut down of the vehicle.

24c. Dometic Refrigerator Model RML9330- Used On Unicorn single axle models

Introduction

The refrigerator, which works silently, meets high quality standards and guarantees the efficient utilization of resources and energy throughout its entire life cycle, during manufacture, in use and when being disposed of.

Guide to These Operating Instructions

Before you start using the refrigerator, please read these operating instructions carefully.

These instructions provide you with the necessary guidance for the proper use of your refrigerator. Observe in particular the safety instructions. Observation of the instructions and handling recommendations is important for dealing with the refrigerator safely and for protecting you from injury and the refrigerator from damage. You must understand what you have read before you carry out a task.

Keep these instructions in a safe place close to the refrigerator so they may be referred to at any time.

Warranty

Warranty arrangements are in accordance with EC Directive 44/1999/CE and the normal conditions applicable for the country concerned. Please contact your retailer in the event of a warranty claim.

Any damage due to improper use is not covered by the warranty. The warranty does not cover any modifications to the appliance or the use of non-original Dometic parts. The warranty does not apply if the installation and operating instructions are not adhered to and no liability shall be entertained.

Limitation of Liability

All information and guidance in these operating instructions were prepared after taking into consideration the applicable standards and regulations as well as the current state of the art. Dometic reserves the right to make changes at any time which are deemed to be in the interest of improving the product and safety.

Dometic will assume no liability for damage in the case of:

- Non-observation of the operating instructions
- Application not in accordance with the regulations or provisions
- Use of non-original spare parts
- Modifications and interferences to the appliance

Environmental Notices

Ammonia (a natural compound of hydrogen and nitrogen) is used in the cooling unit as a coolant. Non-ozone-hazardous cyclopentane is used as a propellant for manufacturing PU foam insulation.

Do not dispose of batteries in domestic waste. Take your used batteries to a collection point.

Energy-Saving-Tips

- At an average ambient temperature of 25°C, it is sufficient to operate the refrigerator at middle thermostat setting.
- Where possible, always store pre-cooled products.
- Do not expose the refrigerator to direct sunlight or any other heat source (e.g. heater).
- Ensure that air circulation of the refrigeration unit is not obstructed.
- Arrange the shelves evenly in the refrigerator (in the cooling compartment) in order to achieve the most efficient use of energy. Do not overfill the storage grids and compartments to prevent obstructing the internal air circulation.
- Maintain a clearance of approx. 10 mm between chilled products and post-evaporator ("cooling fins").
- Defrosting at regular intervals saves energy (see section Defrosting).
- Open the refrigerator door only for a short period of time when removing products.
- Run the refrigerator for about 12 hours before filling it.

Declaration of Conformity

The current Declaration of Conformity can also be requested directly from Dometic GmbH, Siegen.

Safety instructions

Application according to regulations

This refrigerator is designed for installation in recreation vehicles such as caravans or motorhomes. The appliance has been type approval tested for this application in accordance with the EC Gas Directive.

The refrigerator is to be used solely for storing foodstuffs.



The refrigerator is not suitable for the proper storage of medication. Please observe in addition the instructions in the medication package inserts.

User's Responsibility

Anyone operating the refrigerator must be familiar with the safe handling and understand the advice in these operating instructions.

This appliance is not intended for use by persons (including children) with reduced physical, sensory or mental capabilities, or lack of experience and knowledge, unless they are supervised or have been given instruction concerning use of the appliance by a person responsible for their safety. Children should be supervised to ensure that they do not play with the appliance. Cleaning and user maintenance shall not be made by children.

Working Upon and Checking the Refrigerator



Work on gas equipment, exhaust system and electrical facilities must be carried out by authorised personnel only. Substantial damage to property and/or injury to persons can arise through unprofessional procedures.



Never use an unshielded flame to check gas bearing parts and pipes for leakage! This is a danger of fire or explosion.



Never open the absorber cooling unit! It is under high pressure. There is a danger of injury.

Information on Coolant

Ammonia is used as a coolant.

This is a natural compound also used in household cleaning agents (1 litre of Salmiak cleaner contains up to 200g of ammonia

- about twice as much as is used in the refrigerator). Sodium chromate is used for corrosion protection (1.8% by weight of the solvent).

In the event of leakage (easily identifiable from the strong odour), proceed as follows:

- Switch off the appliance.
- Air the room thoroughly.
- Inform authorised customer services.



For your safety it was ascertained in an expert's report that no impairment of health exists when the coolant is discharged.

Appliances with Electronics (MES/AES)

Car manufacturers often use a so-called battery management system, which provides the caravan with constant voltage in trailer mode.

If the car and trailer remain parked for more than 30 minutes with the engine switched off, the battery management system automatically switches off the permanent positive supply to the caravan (to prevent the battery from discharging). Fridges with control electronics (MES/AES) are then inoperative.

Check whether your drawing vehicle is equipped with a battery management system.

A permanent 12v power supply must be guaranteed for operation of the MES/AES fridges.

Operating the Refrigerator with Gas

It is imperative that the operating pressure of the pressure reducer on the gas system corresponds to the data specified on the rating plate of the refrigerator. Compare the operating pressure of the rating plate with the data specified on the pressure reducing valve of the liquid gas cylinder.



Dometic refrigerators are equipped for a connection pressure of 30mbar.



Operating appliance with Gas is not permitted

- At petrol stations
- On ferry boats, and on board motor rail trains
- While transporting the caravan by transported or breakdown vehicle

There is a danger of fire!
Switch off the appliance.

If you Smell Gas

- Open all windows and leave the room.
- Do not operate any electrical equipment and prevent the use of naked flames.
- Do not operate any electrical equipment and prevent the use of naked flames.
- Contact authorised specialist personnel* for advice.

** Authorised specialist personnel*

Authorised specialist personnel are accredited experts who are able, by virtue of their training and knowledge, to vouch that the inspection and repair work has been carried out properly.

Safety Instructions When Storing Foodstuffs

- No refrigerator of any kind can improve the quality of the food; refrigerators can only maintain the food's quality for a short duration as from the time of storing it.
- Please observe the following particular conditions for storing food in a refrigerator that is built into a vehicle:
- A change in the climatic conditions such as temperature fluctuations
- High temperatures inside the vehicle when it is closed and parked in direct sunlight (temperatures are possible up to 50°C)
- A refrigerator built in behind a window and exposed to direct sunlight
- Storing the products too soon, i.e. shortly after starting up the appliance for use
- Use of the refrigerator during travel with the power supply of 12v DC
- Fluctuations in the power supply at the parking place when using the energy type 230v AC (mains voltage).

Under these particular conditions the refrigerator cannot guarantee reaching the temperature needed for perishables.

Perishables include all products with a stipulated use-by date and a minimum storage temperature of +4°C or less, especially for meat, poultry, fish, sausages, pre-packed foods.

- Pack raw and cooked foods separately (e.g. in containers, aluminium foil, etc.).
- Only remove the outside packaging of single packs if all the necessary information, e.g. the use-by date, can also be read on the single packs.
- Please observe the instructions and information regarding the use-by date on the outside packaging of the food.
- Do not leave cooled goods outside the refrigerator for too long.
- Place the foods with the next use-by date at the front, accordingly.
- Pack away any left-over food and eat at the first opportunity.
- Wash your hands before and after handling any food.
- Regularly clean the inside of the refrigerator.
- Please observe section Cleaning of this instruction.



The cooling unit's performance is influenced by ambient temperatures. Please select the medium setting for ambient temperatures between +15°C and +25°C (refer to Setting of cooling compartment temperature). The unit operates within its optimum performance range.

Dometic refrigerators work according to the absorption principle. For physical reasons, an absorption system responds slowly to changes made by the thermostat controller, by loss of cooling energy through opening the door or during storing food. The devices meet the cooling performance requirements of the Climatic Class SN acc. to EN/ISO 7371 in the temperature range of +10°C to +32°C ambient temperature.

Cold air can restrict the performance of the unit. Install the winter covers if you discover any loss of cooling performance when outdoor temperatures are low (see

Operation during low outside temperatures). For ambient temperatures exceeding +32°C for a longer period of time, it is recommended installing Dometic additional fan (item no. 241 2985 - 01).

Refrigerator Operation

The refrigerator is equipped to operate on three power modes:

- Mains voltage (230v AC)
- Direct-current voltage (12v DC)
- Gas (liquid gas propane/butane)

Select the desired power mode by the energy selector switch (battery igniter type models) or the energy selector button (MES, AES). Appliances with automatic energy selection (AES) are additionally provided with "automatic mode" function. Then the AES system automatically selects the best energy source for each particular situation.



- When the appliance is first put into operation, there may be a mild odour which will disappear after a few hours.
- Park the vehicle level, particularly when starting up the refrigerator and filling with food before starting a journey.
- The cooling unit is silent in operation.
- The refrigerator will take several hours to reach its operating temperature in the cooling compartment. The freezer compartment should be cold about one hour after switching on the refrigerator.

Cleaning

Before starting up the refrigerator, it is recommended that you clean it inside and repeat this at regular intervals.

Use a soft cloth and lukewarm water with a mild detergent. Then wipe out the appliance with clean water and dry thoroughly.

Keep the condensation water drain channel free of deposits.

To avoid material alterations, do not use soap or hard, abrasive or soda-based cleaning agents. Do not allow the door seal to come into contact with oil or grease.

Maintenance

- In compliance with the applicable regulations, please note that the gas unit and the connected ventilation ducts must be checked by authorised technical personnel after first use and after every other year for compliance with the European Standard EN 1949. A test certificate has to be issued. It is the user's responsibility to arrange this test.

- The gas burner must be inspected and cleaned as necessary at least once a year. When using liquefied petroleum gas (tank or refill cylinders) the maintenance interval is reduced to half-yearly or quarterly.
- Keep the evidence of maintenance work carried out on your refrigerator.
- Work on gas and electrical equipment shall be carried out by qualified personnel only.
- It is recommended that this is carried out by an authorised customer services department.

We recommend maintenance following an extended shut-down of the vehicle. Please contact our customer services.

Electrical Operation

12v-voltage (on-board power supply)



The refrigerator should only be used in 12v DC operation whilst the caravan is being towed, otherwise the on-board battery would be discharged within a few hours.

Mains power 230v



This operation should only be selected where the supply voltage of the connection for power supply corresponds to the value specified on the data plate. Any difference in values may result in damage to the appliance.

Gas Operation (Liquid gas)

- The refrigerator must be operated using liquid gas (propane, butane) (no natural gas or town gas).
- When using LPG gas, please consider that the burner needs cleaning at shorter intervals due to the gas combustion method (2 - 3 times per year recommended)
- In Europe, gas operation is permitted while travelling only on the condition that the gas system of the vehicle is equipped with a hose rupture protection. The national regulations of the respective country must be observed.
- For physical reasons, gas ignition faults could occur starting from an altitude above sea level of approx. 3280ft. / 1000m (No malfunction!)
- On the initial refrigerator start-up or after a cylinder change, air may be trapped in the gas line. To purge the air from the lines,

switch on the refrigerator and any other gas appliances (e.g. stove) for a short time. The gas ignites without delay.

- Each refrigerator with manual ignition is equipped with an automatic flame safety valve which interrupts the gas supply automatically after approx. 30 seconds when the flame has extinguished.

As a basic rule, gas operation is prohibited in petrol stations!

Prior to Starting the Refrigerator in Gas Mode:

- Open the gas cylinder valve.
- Open the shut-off valve for gas supply to the refrigerator.

Explanation of Operating Controls

Electrical Operation

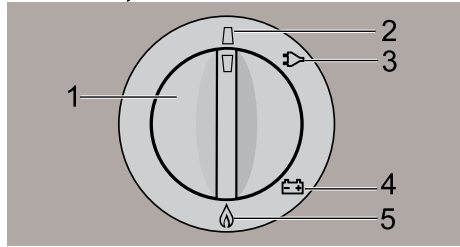

Switch on the appliance by turning the energy selection switch (1) clockwise to position:

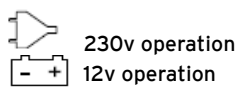
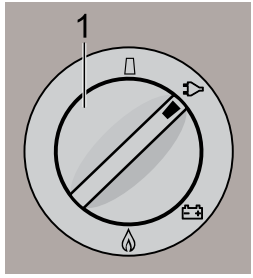

REFRIGERATORS

Gas Operation

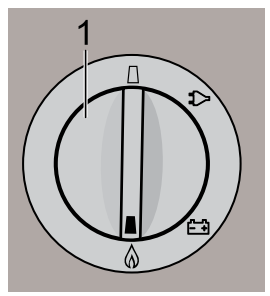
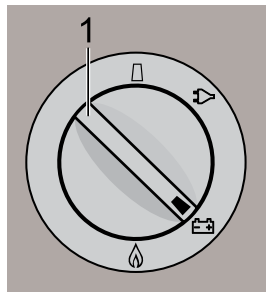

1. Turn the rotary selector switch (1) to position
2. Turn the temperature selector (2) clockwise and push. Keep the controller button depressed.
3. Then, press knob (3) of battery igniter down and keep it depressed. The ignition process is activated automatically.
4. Once the flame ignites, the pointer of galvanometer (4) begins moving into the green range. The refrigerator is operational. Keep knob (2) depressed for approx. 15 seconds and finally release it.

Setting of Cooling Compartment Temperature

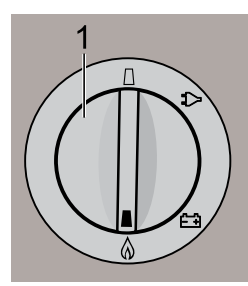

Select the desired cooling compartment temperature by turning the rotary knob (2). The scale starts with MIN position (small bar = highest temperature) and climbs up to MAX position (large bar = lowest temperature).

Note: The temperature levels do not relate to absolute temperature values.

Please select the medium setting (A) for ambient temperatures between +15°C and +25°C. The unit operates within its optimum performance range.



- 12v operation: The refrigerator operates without thermostatic control (continuous operation).

Door Locking



As a basic rule, shut and lock the refrigerator before you start your journey!



Do not open the refrigerator door too far. The door can be damaged if it is opened too far.

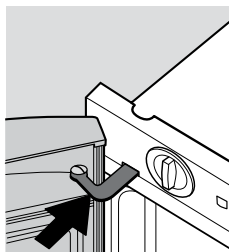

Door opening limit available as option

Lighting

The interior lighting is controlled using a sensor. Should the door be kept open more than 2 minutes, an acoustic signal is initiated (pulsing whistle tone), except for models with battery igniter.

Storage Racks and Door Shelves

The central storage racks (1) are secured. In this way inadvertent entrapment and suffocation of children is prevented, if the storage racks are removed. To protect children it must be avoided to create space for children in the cooling compartment.

If it is necessary to remove these storage racks (1) yet (i.e. for cleaning), first loosen the locking pins (2) as shown with a suitable screwdriver (s. Fig. 25 - 26). The storage racks may be pulled out by loosening the two

locking devices (3) underneath. For loosening pull the slider to the middle, for fastening pull them sideways.

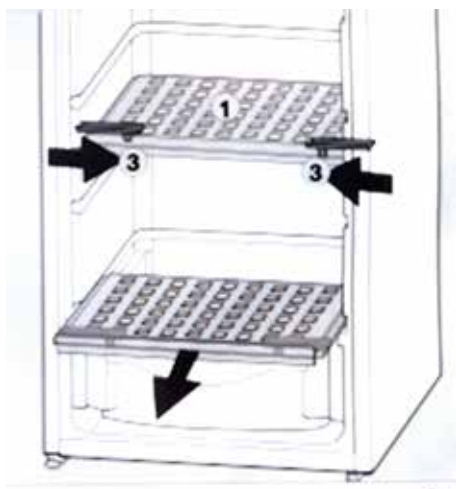

Put in place the locking pins (2) after removing the storage racks.



Remove the central storage racks for cleaning only! Place and lock the storage racks at the same place afterwards.

Thus children have no space to be entrapped in the refrigerator.

Door Shelves

Maximum four door shelves (4) can be installed in the door. To remove the shelves, press slightly together at the sides and replace them in mountings at the required place again.

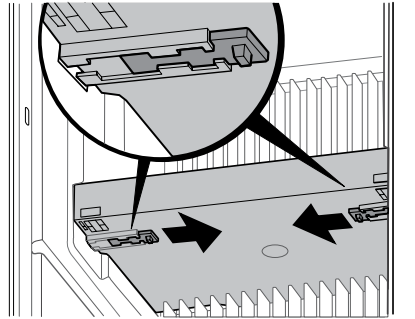
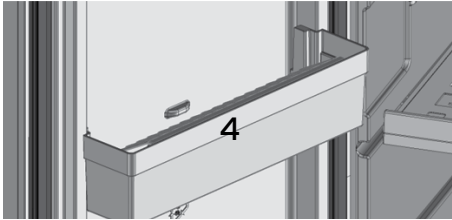

Removable Freezer Compartment

- To enlarge the cooling compartment, just remove the freezer compartment.
- Unlock the freezer compartment door using a screwdriver (Fig. 30).
- Remove the freezer compartment door.
- Unlock the freezer compartment shelf on both sides.
- Pull out the freezer compartment shelf. Store the parts of the freezer compartment safely in order to prevent damage.

Perform the assembly in reverse order.

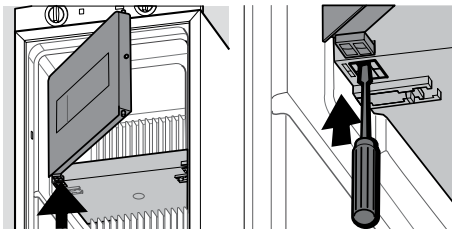
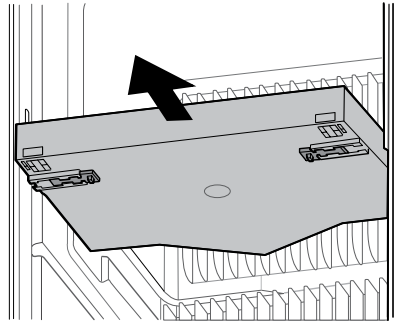

Removing the Crisper

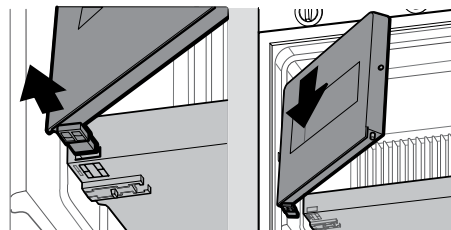
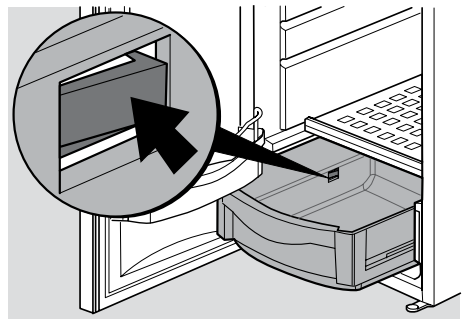

Removal

- Pull out the vegetable bin up to the end top.
- Press in the end stop in both slide rails.
- Remove the vegetable bin.

Installing

- Insert the vegetable bin in the rails and push it in completely.
- After the engagement, the vegetable bin is secured against being pulled out completely again.

The vegetable bin can be pulled out at a 90° angle when opening the door.

Operation During Low Outside Temperatures

Check regularly that the ventilation openings (1) (2) have not been blocked by snow, leaves or similar.

Cold air can restrict the performance of the unit. Install the winter covers (3) if you discover any loss of cooling performance when outdoor temperatures are low. This protects the unit against excessively cold air.

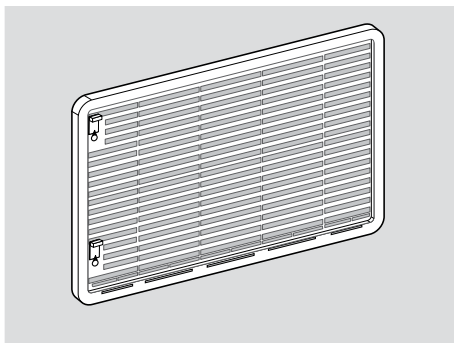
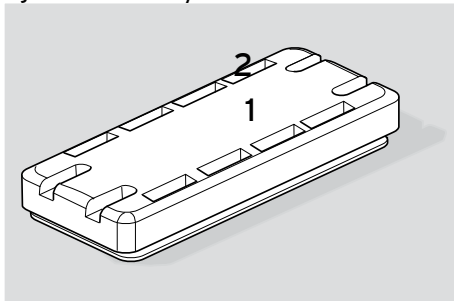

Installing the winter cover

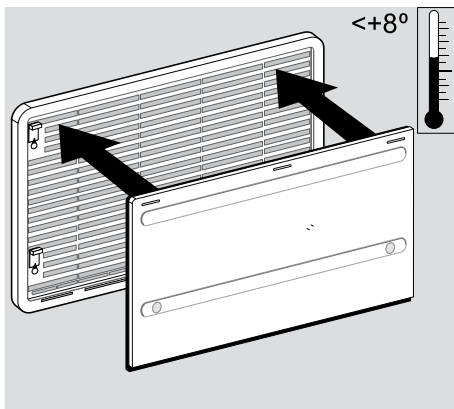

You should also attach the winter cover if the vehicle is taken out of service for a longer period of time or while it is being cleaned from the outside.

Storing Food and Making ice Cubes

Storing products in the cooling compartment

- Switch the refrigerator on approx. 12 hours before filling it.
- Always store pre-cooled foods in the refrigerator. Make sure that the food is well cooled when it is bought and also when transporting it. Use insulated cooling bags.
- Open the refrigerator door only for a short period of time when removing products.
- Products must be packed - best of all in closed containers, wrapped in aluminium foil or similar - and stored separately from each other, in order to prevent drying out or odours.
- Allow foods that have been warmed up to cool down before storing.
- Avoid storing products in the refrigerator that could emit volatile flammable gases.
- Do not overfill the storage grids and compartments to prevent obstructing the internal air circulation.
- Maintain a clearance of approx. 10 mm between chilled products and post-evaporator ("cooling fins").
- Do not expose the refrigerator to direct sunlight. Please bear in mind that the temperature inside a closed vehicle increases sharply if exposed to sunlight and that this can reduce the efficiency of the refrigerator.
- Ensure that air circulation of the cooling unit is not obstructed. Keep the ventilation grilles free from obstructions.

Storing Products in the Freezer Compartment

- Do not keep carbonated drinks in the freezer.
- The freezer compartment is suitable for making ice cubes and for short-term storage of frozen food. It is not suitable as a means of freezing foods.

When ambient temperatures are lower than $+10^{\circ}\text{C}$ and the refrigerator is exposed to these temperatures for extended periods of time, an even regulation of freezer temperature cannot be guaranteed for system related reasons. This can cause the temperature in the freezer to rise and the stored goods to melt.

Making Ice Cubes

Ice cubes are best frozen overnight. At night, the refrigerator has less work to do and the unit has more reserves.

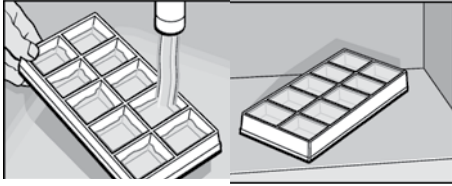

- Fill the ice cube tray with drinking water
- Place the ice-cube tray in the freezer compartment



Only use drinking water.

Refrigerator Compartments



1. Freezer Compartment: Already frozen food (deep frozen food)
2. Middle Compartment: Dairy products, convenience foods.
3. Bottom compartment: Meat, Fish, food for defrosting

4. Vegetable compartment: Salad, vegetables, fruit
5. Top Door Shelf: Eggs, butter
6. Middle Door Shelf: Cans, dressings, ketchup, jam
7. Bottom door shelf (drinks compartment): Drinks in bottles or bags

Shutting off the Refrigerator

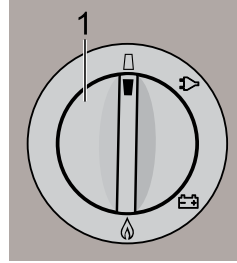

Set energy selector switch (1) to position "OFF". The appliance is switched off (Fig. 43).

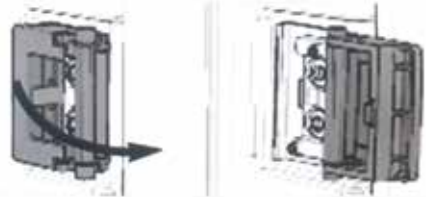

- Unlock the catch of the door lock by pulling and folding forward. If the door is closed in this position, a small gap is nevertheless kept open to prevent formation of mildew.
- If the refrigerator is to be taken out of service for an extended period of time, close the on-board shut-off valve and the cylinder valve.

Defrosting

As time goes by, frost builds up on the fins inside the refrigerator. A layer of frost thicker on one side may occur and does not represent a malfunction. When this layer of frost is about 3 mm (0.118 inches) thick, the refrigerator should be defrosted.

- Switch off the refrigerator, as described in section Shutting of the refrigerator.
- Remove all food and the ice cube tray.
- Leave the refrigerator door open to allow air to enter and to prevent formation of mildew.

- After defrosting (freezer compartment and fins free of frost), wipe both cooling compartments dry with a cloth.

Note: Water thawing in the main compartment of the refrigerator runs into an appropriate container at the back of the refrigerator. From there, the water evaporates



The layer of ice must never be removed forcibly, nor may defrosting be accelerated using a heat source!

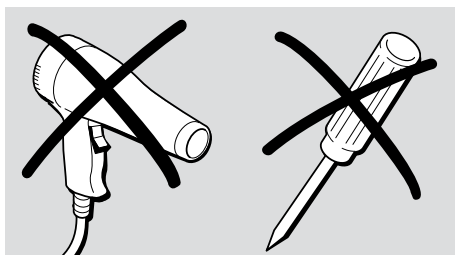

Exchange of the igniter's battery

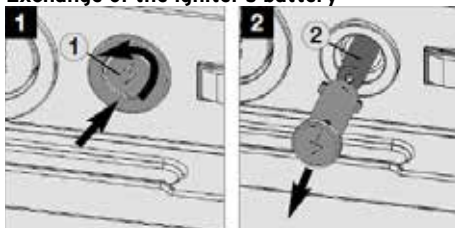

Unlock the battery (2) by depressing and turning the button (1) approx. 90° counter-clockwise (by means of a suitable screw driver). After removing the cap, the battery (1.5 V AAA/R3/Micro) can be removed and replaced. Observe correct polarity!



Do not dispose of batteries in domestic waste. Take your used batteries to your dealer or a collection point.

Trouble Shooting

Failure: The refrigerator does not cool sufficiently.	
Possible Cause	Action you can Take
Inadequate ventilation to the unit	Check that ventilation grilles are not covered
Thermostat setting is too low	Set thermostat to higher level
The condenser is heavily frosted	Check that the refrigerator door closes properly
Too much warm food has been stored inside within a short period of time	Allow warm food to cool down before storage
The appliance has been running for only a short period of time.	Check whether the cooling compartment works after approx. 4-5 hours.
Ambient temperature is too high	Regularly remove ventilation grilles.
Failure: The refrigerator does not cool in gas operation mode.	
Possible Cause	Action you can Take
Gas cylinder empty	Change the gas cylinder
Is the upstream shut-off device open?	Open Shut-off valve
Air in the Gas Pipe?	Switch off the appliance and start again. Repeat this procedure 3-4 times, if necessary
Failure: The refrigerator does not cool in 12v operation	
Possible Cause	Action you can take
On-board fuse defective	Fit new fuse.
On-board battery discharge	Check battery, charge it.
Engine not running	Start engine
Heating element defective (please also refer to failure indication).	Please inform the Dometic Customer Services.
Failure: The refrigerator does not cool in 230v operation	
Possible Cause	Action you can take
On-board fuse defective	Fit a new fuse.
Vehicle not connected to mains supply voltage	Make connection to a mains power supply
Heating element defective (please refer to failure indication)	Please inform the Dometic Customer Services

Please visit www.dometicapproved.co.uk or telephone -44 (0) 844 626 0130 to locate your local service centre. Installation may only be carried out by authorised personnel. We recommend contacting your Dometic Service Centre.

25. STAINLESS STEEL SINK

Stainless steel sinks need little maintenance other than cleaning immediately after use. Most deposits can be removed by washing with soap or mild detergent and hot water, followed by a clean water rinse and drying with a soft cloth to prevent water spotting.

For more tenacious deposits a non-abrasive multi-purpose cream cleaner such as CIF should be used, followed by a clean water rinse and drying.

Tannin stains can be removed by a solution of washing soda and water applied with a soft cloth/sponge followed by a clean water rinse to remove any residues, and drying with a soft cloth.

(When cleaning with anything other than water be careful not to get the solution onto your kitchen worktop.)

Scratching will be most noticeable on highly polished components. These marks are usually only superficial and can be removed with a proprietary stainless steel cleaner/polish. A useful alternative is a car paint restorer, such as "T-Cut". If the surface has a directional polished grain always clean along the grain and not across it.

Always avoid bleach and trigger-dispense products and never use wire wool or leave wet cloths, pads or containers on the surface as they may form water marks.

IMPORTANT

To preserve the appearance of your appliance we recommend plastic bowls or mats are not stored in the sink. This is particularly the case when travelling because vehicle movement may cause the plastic bowl to vibrate/rub against the surface and leave marks.

26. SMOKE ALARM

The smoke alarm is operational once the battery is connected. When products of combustion are sensed, the unit sounds an alarm until the air is cleared.

Features

- Battery operated
- The operating light (red LED) flashes every 40 seconds confirming that the unit is powered.
- Low battery warning: the unit will emit an audible "chirp" once every 40 seconds for 7 days before the battery needs to be replaced. Failure to replace the battery will result in insufficient power to alert you in a real fire situation.
- Sensitivity test button. This tests the sensitivity, circuitry, battery and horn.
- Loud alarm.



Test smoke operation after vehicle has been in storage, before each trip and at least once a week during use.

Your alarm requires one 9v battery. Under normal use, the battery should last one year.

Simple Maintenance

- Clean your smoke alarm once every three months to help keep the unit working correctly. Gently vacuum using a soft brush attachment.

Problems are indicated by two events:

The alarm does not sound upon pressing the test button.

The operating light remains steadily on or off (i.e. does not flash every 40 seconds, when the unit is not in alarm).

Try the following:

- Inspect for obvious damage.
- Check that the unit contains recommended battery type.
- Check that the battery cover has been removed.
- Check that the battery is properly connected.
- Gently vacuum as recommended above.
- Replace battery.

If these procedures do not correct the problem, do NOT attempt repairs; replace the smoke alarm.

31. SOFT FURNISHINGS

Carpet

When cleaning the interior of your caravan please remove the carpet from the vehicle. Vacuum the carpets to take the dirt out of the pile.

For general cleaning use a dry shampoo, following the product's directions.

For stains, use a mixture of 1/3 bleach to 2/3 warm water. Immerse a soft cloth in the solution until wet, then wring and squeeze the cloth until damp. Rub the affected area until the stain has gone.



NEVER USE DRIPPING WATER

The proportion of water to bleach must be accurate.

Never put the carpet in a washing machine or a tumble dryer.

Upholstery

Cleaning and Care

Remove dust on a regular basis with your vacuum's upholstery or drape attachment. Try to avoid brushing fabric covers because that can damage the pile.

If you spill something on your upholstery, blot up the excess immediately. Avoid detergents which may damage the fabric's protection. Use a sponge or a clean white cloth but do not wash or rub the fabric. Leave to dry in normal conditions. These actions will not affect the FR (Fire Retardant) treatment of the fabric.



Heavy soiling will require professional cleaning.

All fabrics will fade to some degree if exposed to direct sunlight, particularly natural fibres such as cotton etc.

Try not to leave newspapers lying on your cushions; ink can stain the covers. It isn't always easy to prevent that from happening; however, proper ventilation can help.

Try to keep pets off the upholstery and be careful of sharp objects such as belt buckles, toys and watch straps snagging the fabric. If snags do occur, carefully cut off the loose ends with scissors or tuck back in-do not pull them under any circumstances.

Winterisation and Storage

Mattresses are made from fire retardant fabric and are a CMHR foam encapsulated sprung

unit. It is recommended that mattresses be stored on edge during winter.

Try to keep your cushions away from direct sunlight.

Curtains

It is recommended that the curtains in your caravan are washed on a delicate cycle at 30°C. This will not damage the clip glides.

Shrinkage may be caused should you decide to dry clean your curtains.

Curtains should not be left closed during daytime otherwise some fading will occur.

32. REMIS BLINDS

REMIBASE PLUS WINDOW BLINDS.

Please note the blinds should not be in the closed position when the vehicle is travelling or when in storage for extended periods.

The sun screen is housed at the bottom and the fly screen at the top of the blind. To open either hold the cross bar and pull up or down. Both blinds can be fully extended to totally cover the window or can meet at any position to give sun shading/privacy and protection from insects entering the vehicle.

The blinds are pre-set to the correct tension. If re-tensioning is required please follow these steps:

- The blind needs to be taken down from the wall by un-screwing the 4 corner screws.
- Lay the blind face down on a table with the cross bars of both blinds meeting in the middle.
- The black cords re-tension the fly screen and the white cords re-tension the sun screen.
- The cords are fixed at either side with a screw. Loosen this screw and gently pull the cord 5mm tighter and repeat on the other side ensuring the cross bar is level.
- Test the tension. This process can be repeated if necessary.

Cleaning

The actual plastic profiles can be cleaned with a non-abrasive cleaner and damp soft cloth. The blinds should only be dusted lightly with a soft cloth.

Remi Flair Function

Both the sun screen and the fly screen are stored at the top. The sun screen can be pulled down and fixed at any of the stops in the side supports. The fly screen can be pulled down and fixed at the bottom of the side supports. When released from the fixing points the blinds will automatically retract. **BEWARE: DO NOT ALLOW THE BLINDS TO RETRACT TOO FAST AS THIS WILL CAUSE DAMAGE.**

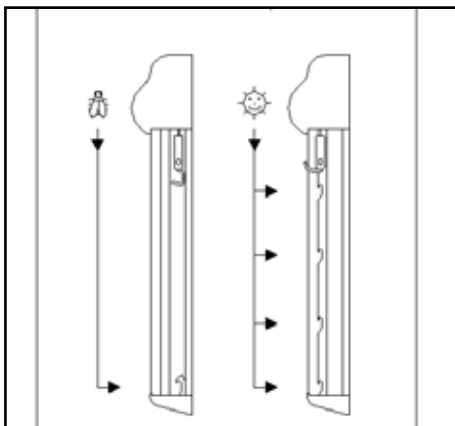

Re-tensioning. If this is required on either blind the screw slot on the side should be turned once and the blind tested. If the tension is still not correct a further turn may be required.

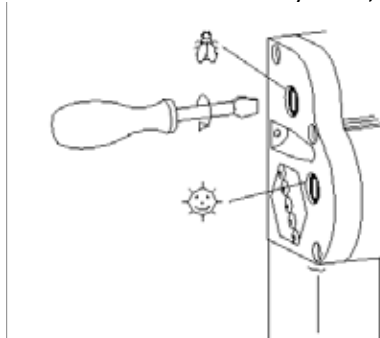

Maintenance

The sun screen can be wiped with a non-abrasive cleaner as can the cassette holder. The fly screen can be cleaned with a soft brush.

Neither blind should be closed (in the down position) when the vehicle is being towed or in storage for prolonged periods.

33. STATUS 550 DIGITAL ANTENNA SYSTEM

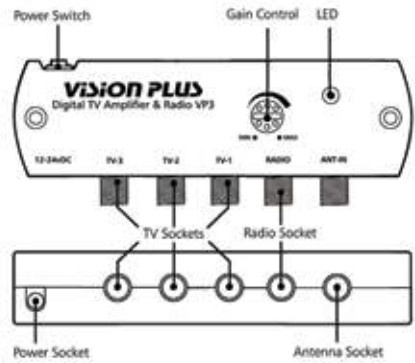

Frequency Range:	UHF 470-860 MHz
	FM 88-108 MHz
	DAB 175-230 MHz
Antenna forward gain	7db
Amplifier gain	16db
Gain adjustment	15db
Noise figure	2.8db
Output impedance	75ohms
Output	95dbuv
Power supply	12-24vDC
Power consumption	55ma
Signal outputs	2 TV 1 Radio

Travelling



Do not travel:

- With the antenna raised.
- With the antenna set for vertical signals.
- When travelling adjust the antenna so that it points to the rear of the vehicle to reduce the possibility of damage when travelling.

Operating

- Firstly determine the approximate location of the nearest transmitter and whether the signals are horizontally or vertically polarised. For assistance ask your site operator or check other antennas in the vicinity.
1. Loosen the mast locking collar and raise the antenna. Rotate the mast to direct the antenna towards the TV transmitter.
 2. The H/V indicator on the bottom of the mast indicates the back of the antenna.
 3. Should you need to receive vertically

- polarised signals rotate the winder anti-clockwise to tilt the antenna through 90°.
4. DO NOT use undue force on the winder.
5. Switch ON the amplifier and the LED will illuminate.
6. Check the gain control is set to maximum. For maximum rotate clockwise.
7. Tune your television into the strongest signal. You may need to adjust the direction of the mast to achieve the best picture quality.
8. Secure by tightening the mast locking collar.

DAB and FM Radio Operation

Status is designed to receive DAB and FM when connected to a radio with DAB/FM facility.

Dependent on location, DAB and FM reception may be improved by setting the antenna to vertical.

Fault Finding

The following are some of the key areas we suggest you check which generally solve the most common problems encountered with the operation of the Status antenna.

Coaxial connections

It is critical that all connections in the system are fitted correctly.

Gain Control

In normal use the button should be rotated clockwise for maximum. In strong signal areas the amplification may need to be reduced. To reduce amplification rotate the button anti-clockwise until picture quality improves. The button rotates through 270° from MAX to MIN.

LED Light

Should the LED on the amplifier not light, firstly check there is power to the unit. Secondly check the polarity is correct. Otherwise contact Grade UK Ltd for further assistance.

Short Hook Up-Test 1

This test isolates the wiring from the amplifier through to your TV/radio points. Unplug the coaxial plugs from the "TV" sockets of the amplifier and use your TV fly lead with converter 1 supplied. Connect your TV to the amplifier.

Please ensure the antenna dome is plugged directly into the "ANT-IN" socket of the

amplifier and switch on. Tune in your TV for the strongest signal.

If the picture quality improves the fault lies with the wiring of the system between the amplifier and TV outlet socket.

Short Hook Up: Test 2

This test isolates the amplifier by connecting your TV direct to the antenna.

Unplug the antenna from the amplifier and connect converter 2 supplied to the plug on the cable end. Using your fly lead connect the antenna directly to your TV. Tune in your TV for the strongest signal.

If the picture quality improves, the fault lies with the amplifier.

Antenna Dome Coaxial Cable

Check the routing of the coaxial cable from the antenna dome to the amplifier. Check to ensure there are no kinks or trapped cable or if there are loops of surplus cable which could affect performance.

Should you still be experiencing difficulties and require assistance, please do not hesitate to contact Vision Plus for further assistance on +44 (0) 115 986 7151 or visit www.visionplus.co.uk



It is the responsibility of the caravan owner to make sure that the directional aerial is fully retracted before the caravan is moved. Any damage as a result of neglect, i.e. not retracting the aerial or caused by crash damage, vandalism or incorrect operation will NOT be covered by the manufacturer's warranty.

34. GENERAL CARE AND MAINTENANCE OF YOUR CARAVAN

Exterior

The exterior of your caravan is very durable and easy to clean owing to its high gloss properties. To maintain a showroom finish, one needs only to wash the caravan and the parts monthly (or more frequently), using Care-avan* Caravan Cleaner, but avoid using strong alkaline (e.g. tri-sodium phosphate) or acidic cleaners or abrasives. Waxing the components once or twice a year with a good grade paste wax will help to maintain the colour and finish.

Cleaning/Usage Information:

- Wash the caravan by hand, using a sponge with plenty of Care-avan* cleaning solution to avoid scratching.

* Available through your supplying Bailey Retailer or available to order direct via our Parts Direct website:

www.bailey-parts.co.uk

- Always rinse away any cleaner from your caravan.
- Dry the vehicle with a chamois or a microfibre cloth.
- It is imperative to ensure that the area surrounding the rooflight is completely dried; this will avoid both condensation and damp collecting around the perimeter.
- Where possible position the vehicle nose down for a short period to avoid water pooling and collecting on the roof area.

Do not

- Do not apply a carnauba-based wax to the vehicle.
- Do not use a mechanical brush washing system such as a car wash.
- Never pressure wash your vehicle.
- Do not use solvents.
- Do not use acrylic cleaners.



Under no circumstances use any abrasive agents, methylated spirit, white spirit or other solvents to the exterior of your caravan.

No touch up painting should be carried out prior to consulting with a Bailey Service Centre for approved methods.



All items stored in the gas bottle storage locker must be secured to prevent impact damage to the inside of the body panel when the caravan is being towed.

Do not allow any chemicals, toilet or otherwise, to spill or leak into the gas box floor. Before placing items in the cradle ensure that the tray is clean and free from any debris. Cleaning should only be carried out with warm soapy water.

The use of high pressure water jets to clean your caravan will invalidate your warranty.

Acrylic Windows

The windows fitted to your Bailey caravan are manufactured from high quality acrylic using the latest plastic processing methods.

For cleaning, use only generous amounts of water to wash away dust and road grit etc. Then use a soft cloth and warm soapy water and gently remove the remaining dirt. Avoid abrasive cleaning materials and detergents.

As with all plastic materials, acrylic should not be allowed to come into contact with chemicals such as paint remover, fly spray, acetone, dish washer detergent and car cleaning detergent.



Never polish with a dry cloth. During high sun do not close the window blinds completely and open the windows into the ventilation position. While the caravan is in motion please ensure that the windows are fully closed (this information is also detailed on stickers on the windows).

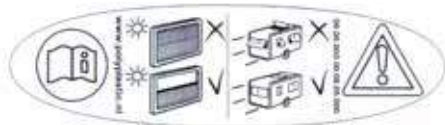

Dependent on the temperature inside the caravan compared to that outside, condensation may be experienced between the window panes. This is a perfectly normal occurrence as the windows are not sealed units. To disperse condensation remove the bungs, using a pair of blunt end tweezers, in the corners of the

window unit (preferably on a warm day) until the condensation disperses and then replace the bungs.

Window Catches and Stays

Turn catch arm to the vertical position to open. A night vent position is available by depressing the locking knob and locating the catch into the outer catch plate slot.

The windows are held open by an adjuster knob; tightening the knob in a clockwise direction will hold the window open in the desired position.



Always ensure the knob is unscrewed before closing the window. Failure to do so may cause damage to the window stay arm.

Always ensure that windows are fully closed during wet weather and not on night vent settings.

Humidity

Air contains moisture – this is called humidity. The higher the temperature of the air, the more water it is able to hold. Air at 20°C can hold a lot more moisture than air at 10°C. The term “relative humidity” describes how much moisture air contains at a given temperature. 100% relative humidity means the air is holding as much moisture as it can at that temperature.

The more humid the air is in your caravan, the more energy it takes to warm your van because it is also warming the water in the air. This means it will be more expensive to heat! A good range of indoor humidity for comfort and health is between 30 and 60% during cooler months of the year. Mould is likely to occur if the relative humidity indoors is 70% or more for long periods of time. Keeping humidity levels under 50% also helps to minimise or control dust mites.

About Condensation

When the humidity is high inside a van and it is cold outside the water vapour condenses on cold surfaces. What can dampness and condensation in your van?

- Lack of adequate ventilation and/or heating
- Water coming in from the outside through leakage, seepage or open windows
- High levels of moisture/water vapour being produced inside the caravan

Humid air and condensation can also be generated by things people do on a daily basis.

- Cooking: up to 3 litres per day
- Showers: 1.5 litres per person
- Washing dishes: up to 1 litres per day
- Breathing: active adult 0.2 litres an hour per person
- Breathing, adult asleep: 0.02 litres an hour per person

How to Keep Your Caravan Dry and Avoid Condensation

There are lots of things YOU can do to minimise dampness and condensation in your caravan.

The key actions:

- Provide ventilation and/or reduce relative humidity of air, particularly in moisture-prone periods of year (especially winter time) and when the moisture is produced in the van (cooking, shower)
- Reduce the amount of moisture produced in the van
- Increase heating to raise the temperature of the air and the cold surfaces

On dry days open some windows to allow humid air to ventilate out of the van. It is better to open a few windows a little throughout the whole caravan. This helps the air to move through the caravan. One window open wide may not be as effective. Try to do this as often as possible (at least once a week), but keep windows closed on wet days as damp air may increase indoor humidity.

High Temperatures

High temperatures can also damage the surfaces of your worktops. Protect them with protective table pads or place-mats when using extremely hot utensils or dishes.

Furniture

Moisture in the air can cause damage to furniture as the wood expands or contracts with an increase or decrease in the relative humidity. A relative humidity of between 40% and 60% is tolerable. If values are maintained outside this range for a sustained period damage to the furniture may occur.



To prevent damage, assure relative humidity of air is not too high.

The damage can be visible if the relative humidity is higher than 80% for a long time. To prevent damage, ventilate the van, using

dehumidifiers or water absorbent substances. When wood is wet, wipe it dry. Do not just wait for the sun to dry it. The longer the water stays on the surface, the more damage it can do. Defects caused by swelling, bowing, twisting or de-laminating generated by high temperature or high relative humidity of air will not be accepted as warranty.

Hinges and Catches

Lightly oil occasionally.

35. CARAVAN KEYS

Each Unicorn model is supplied with 2 identical keys. In the event of both keys being lost these cannot be replaced. In this instance a new lock will have to be fitted with a fresh set of keys.

All Pegasus GT65 and Pursuit models have a high security lock for the entrance door and 2 keys for this lock are provided. In the event of both keys being lost these cannot be replaced. In this instance a new lock will have to be fitted with a fresh set of keys. The other 2 keys are for the exterior locker and storage doors.

36. WINTERISATION & STORAGE

The following applies whenever your caravan is stored, particularly during winter months.

- If you will not be using your vehicle for a while it is probably a good time to arrange for your caravan to have its annual service at your appointed dealer.
- As with all caravans it is a good idea to store the caravan with the nose down; this will avoid any water pooling on the roof.
- Do not leave your vehicle near trees or latch-type gates due to possible wind damage.
- Keep any grass around the floor of the caravan short to maintain airflow and stop any possible damp getting into it.
- It is advised that the caravan is ventilated regularly throughout the winterisation/storage period, opening windows, doors and rooflights where possible.
- All moving parts should be checked for free operation.
- Clean all cooking appliances and the refrigerator before parking up the vehicle.
- Charge up the on-board battery every 2 months.
- Leave the refrigerator door open. Leave the furniture and locker doors open to allow air to circulate fully.
- Ensure that the entire water system is thoroughly drained.
- Make sure that all plumbing pipes, drains, and water supply appliances within the caravan are properly drained.
- Remove the battery from the caravan to keep it warmer. If the battery cells were to freeze this could cause damage to the cells and decrease the life of the battery.
- Try to cover as much as possible of the underside of the caravan to prevent snow from collecting and packing up underneath. This will help to prevent damage to the tyres due to weather conditions.
- Apply a lubricant to any of the locks to avoid them from freezing up. This will allow you access to your caravan if it is needed.

37. MODIFICATIONS & DIY WORK

Owners need to be aware that carrying out DIY modifications to your caravan may, in certain circumstances, invalidate the warranty cover and could also affect the safety and structure of the vehicle.

38. SPARES & AFTERSALES

There are numerous parts and accessories available for your caravan either from your Bailey retailer or through the Bailey Parts website. You are more than welcome to contact the parts website for anything you may require. However, if it is a safety or warranty-critical item you will need to obtain it from your Bailey retailer who will fit the component for you.

www.bailey-parts.co.uk

39. PEGASUS GT65 FRONT BED MAKE UP

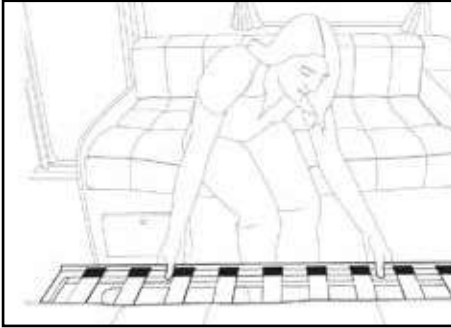

Step 1: Pull out the slats from the underside towards the bunks on the other side of the vehicle.

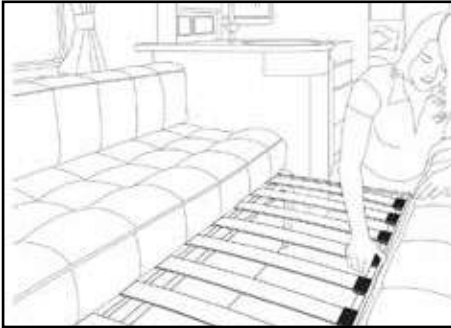

Step 2: There will be a slight gap between the two bunk faces.

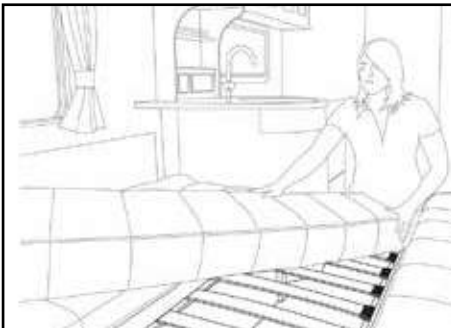

Step 3: Turn the cushions over and move the back rests into the middle.

Step 4: Move the seat base cushions so that the knee roll is against the outside wall of the caravan.

40. RETRACTABLE BED ASSEMBLY

This is only applicable on some models.

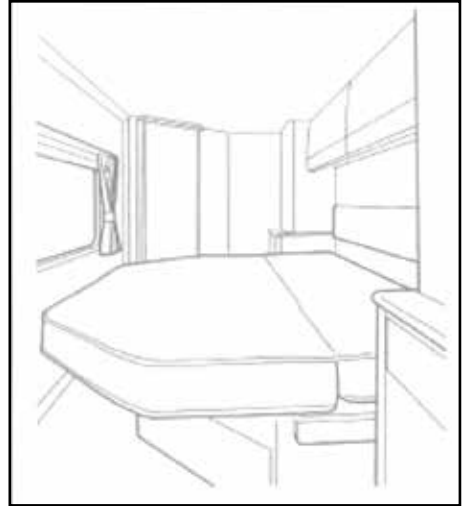

Step 1: To raise the bed, lift the section of the mattress nearest to the headboard and flip it forward. Then push the frame backwards to shorten the bed length. Flip the mattress up to create a relaxed seating position.

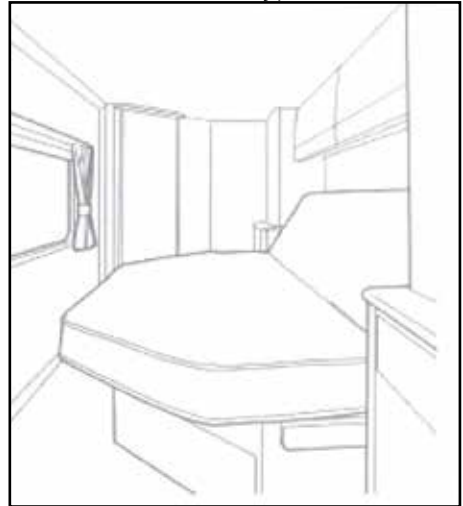

Step 2: To lower the bed, flip the mattress forward again and then pull the bottom of the bed frame towards you until the bed is completely flat. Push the mattress over to make a flat sleeping area.

41. SIDE DINETTE TOP BUNK ASSEMBLY

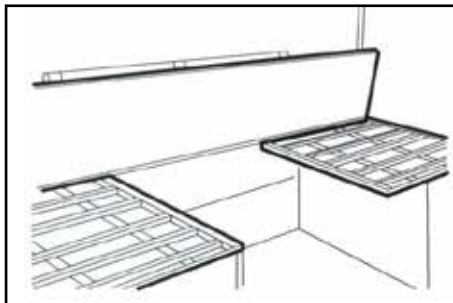

Step 1: Remove the cushions, draw the curtains and close the blind if fitted.

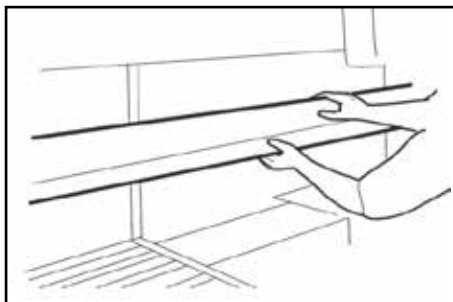

Step 2: Holding the bunk in both hands pull it inwards.

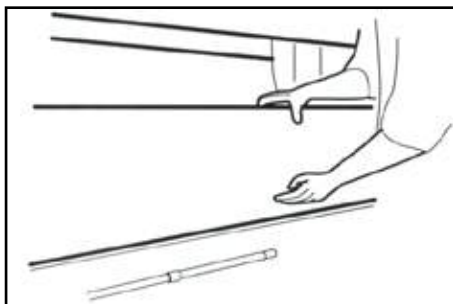

Step 3: While lifting upwards.

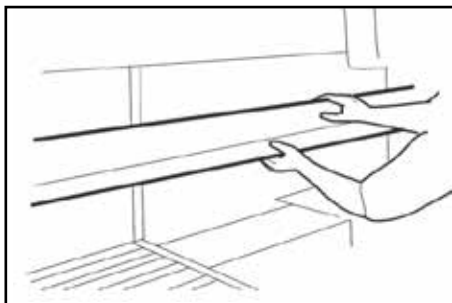

Step 4: The bunk mechanism will automatically lock in the up position.

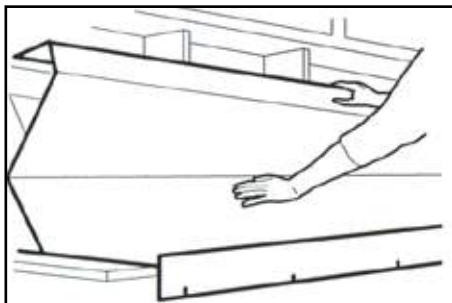

Step 5: Release retaining strap on the underside of the bunk base. The second half of the bunk base can now be unfolded towards the caravan wall.

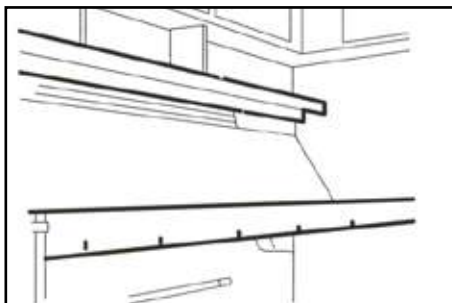

Step 6: Turn the turn-buckle catches located on the metal bunk legs to ensure that the bunk cannot be folded by pushing up from below.

Step 7: The safety rails and ladder can now be slotted into position.

Step 8: Check the security of the bunk and replace the cushions before allowing a person to use the bunk.

42. SIDE DINETTE BOTTOM BUNK ASSEMBLY

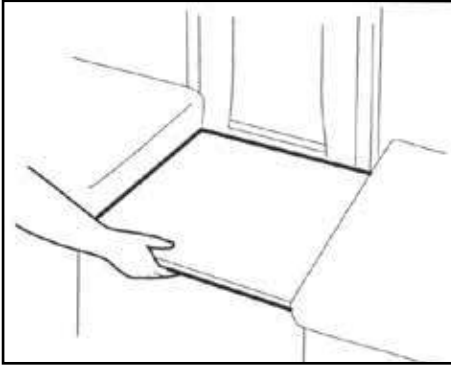

Step 1: Remove the table from the support leg.

Step 2: Place the table top between the seats on the ledge.

Step 3: Arrange the seat cushions as appropriate.



When children, especially those under 3 years of age, use any bunk/bed, care must be taken against the risk of them falling out.

43. USEFUL E-MAIL ADDRESSES AND TELEPHONE NUMBERS

Bailey Customer Services	customerservices@baileyofbristol.co.uk
Bailey spares department	parts@baileyofbristol.co.uk
Criss	+44 (0) 203 282 1000
Michelin Tyre PLC	+44 (0)845 366 1535
AL-KO	+44 (0)1926 81 8500 mail@al-ko.co.uk
Fire Angel	+44 (0)800 141 2561 technicalsupport@fireangel.co.uk
Dometic	+44 (0)844 626 0130 technical@dometic.co.uk
Vision Plus Customer Helpline	+44 (0)115 986 7151
Alde	+44 (0)1933 67 7765 www.alde.co.uk
Whale	+44 (0)845 217 2933 (Heating System) +44 (0)28 9127 0531 (Water System) info@whalepumps.com
Wheel Solutions Ltd	+44 (0)1543 87 0170 info@wsl.uk.com
Clubs	
The Caravan Club	+44 (0)1342 32 6944 www.caravanclub.co.uk
The Camping and Caravanning Club	+44 (0)845 130 7631 www.campingandcaravanningclub.co.uk
The National Caravan Council	+44 (0)1252 31 8251 www.nationalcaravan.co.uk

JVC

Tune into digital clarity

Every great road trip needs a soundtrack, with the JVC KD-DB65E you can open up the world of crystal clear DAB digital radio. Along with your favourite CDs and smartphone playlists. You can access all this including USB connectivity with a touch of a button. For more information on the JVC Mobile Entertainment range just ask your Bailey of Bristol retailer.



|| digitalradio ||



JVC CS-V416 speakers sold separately.

www.jvc.co.uk

MOBILE ENTERTAINMENT